

# CONFIDENTIAL

This document contains Nokia confidential material. This material cannot be shared except with persons that have a valid business reason to read this content. You are personally responsible to ensure recipients of this document are aware of information handling guidelines.

## Service schematics

# Nokia Lumia 630

RM-976 / RM-977

# Lumia 630 Dual SIM

RM-978



## IMPORTANT

This document is intended for use by authorized Nokia service centers only. Please use the document together with other documents such as the Service Manual and Service Bulletins.

## Version information

While every effort has been made to ensure that the document is accurate, some errors may exist. Please always check for the latest published version for this document.

v1.0 - 16.05.2014  
-First approved version.

## Version differences

This document will cover following releases:

Nokia Lumia 630, RM-976, Board: 4GG\_09b (ROW)  
Nokia Lumia 630, RM-976, Board: 4GG\_09c (ROW)  
Nokia Lumia 630, RM-977, Board: 4GH\_09f (Americas)  
Nokia Lumia 630, RM-977, Board: 4GH\_09g (Americas)  
Nokia Lumia 630 Dual SIM, RM-978, Board: 4GJ\_09j (ROW)  
Nokia Lumia 630 Dual SIM, RM-978, Board: 4GJ\_09k (ROW)

## Contents

- 1 Front page
- 2 PM8226, MSM8226, Power, Side keys, USB
- 3 MSM8226, Memory, Display/Touch, SIM(s), Camera, Accelerometer
- 4 Audio, Top flex board, BT/WLAN/FM
- 5 RF Transceiver, GPS
- 6 Component finder Top (RM-976)
- 7 Component finder Bottom (RM-976)
- 8 Component finder Top (RM-976)
- 9 Component finder Bottom (RM-976)
- 10 Component finder Top (RM-977)
- 11 Component finder Bottom (RM-977)
- 12 Component finder Top (RM-977)
- 13 Component finder Bottom (RM-977)
- 14 Component finder Top (RM-978)
- 15 Component finder Bottom (RM-978)
- 16 Component finder Top (RM-978)
- 17 Component finder Bottom (RM-978)



### Send feedback

- Recommend Change in KICS
- Rate this page in KICS
- e-mail [careacademy@nokia.com](mailto:careacademy@nokia.com)

BOM & VARIANT SELECT		RA250			
RA251=56k	56k	22k	10k	4k7	1k8
RA251=22k	b	c	d	e	f
RA251=10k	g	h	i	j	k
RA251=4k7	l	m	n	o	p
RA251=1k8	q	r	s	t	u
RA251=1k8	v	w	x	y	z

BOM & VARIANT VISUAL INDICATION  
 R1013 = 4GK BOM N  
 R1014 = 4GK BOM O  
 R1005 = 4GH BOM F  
 R1006 = 4GH BOM G  
 R1001 = 4GG BOM B  
 R1002 = 4GG BOM C

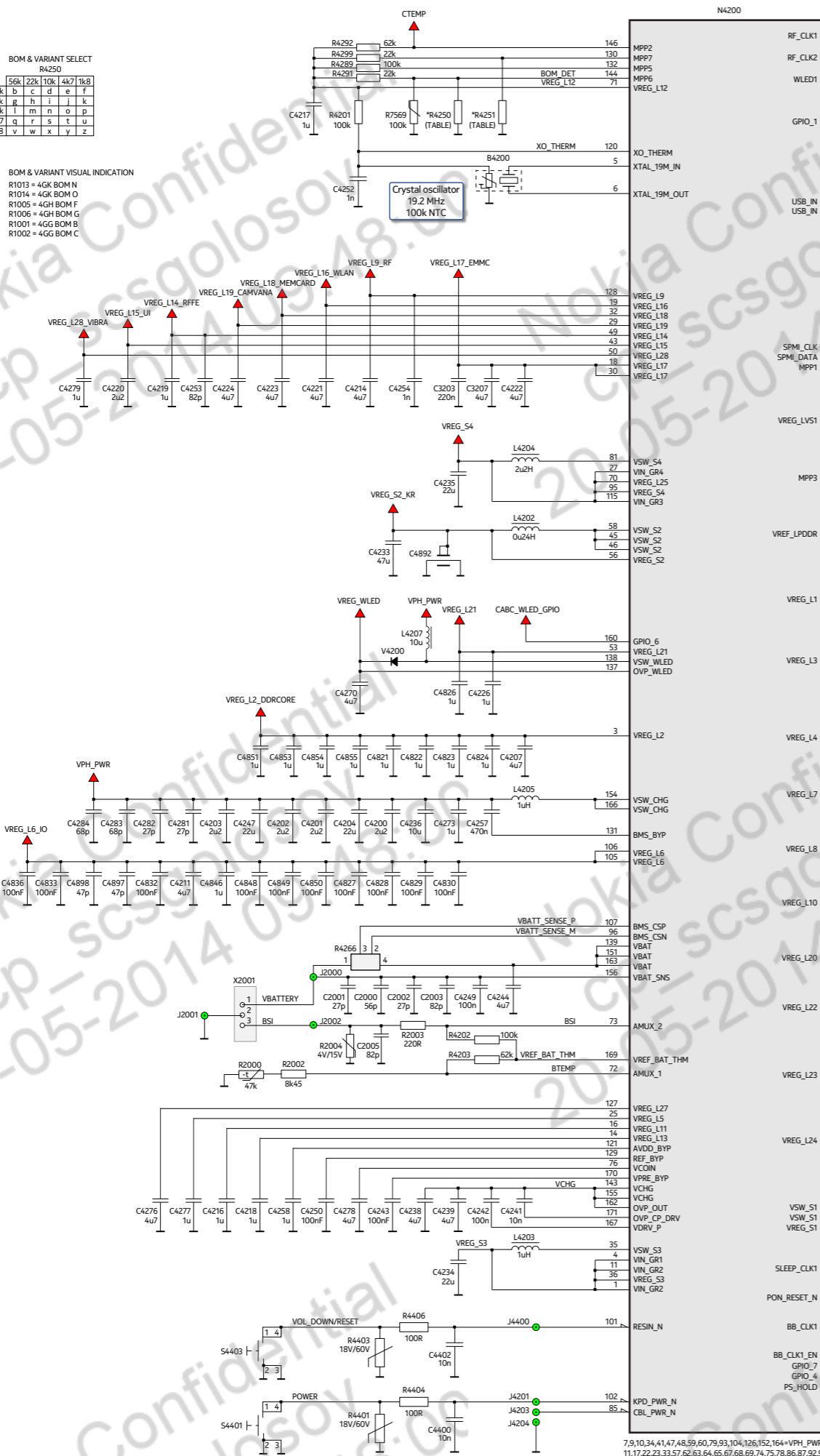

7,9,10,34,41,47,48,59,60,79,93,104,126,152,164+VPH\_PWR  
 11,17,22,23,33,57,62,63,64,65,67,68,69,74,75,78,86,87,92,98,99,108,109,110,113,114,117,119,142,150,153,165=GND

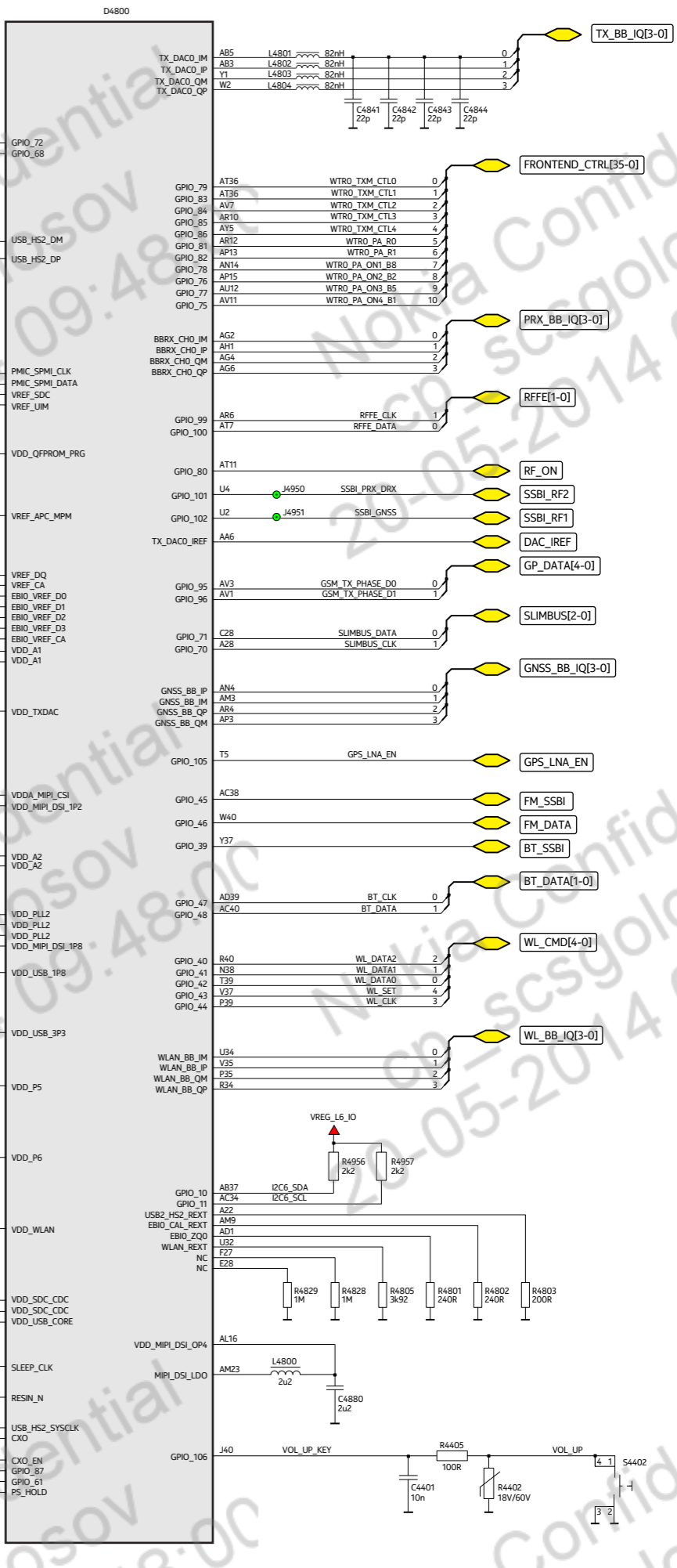
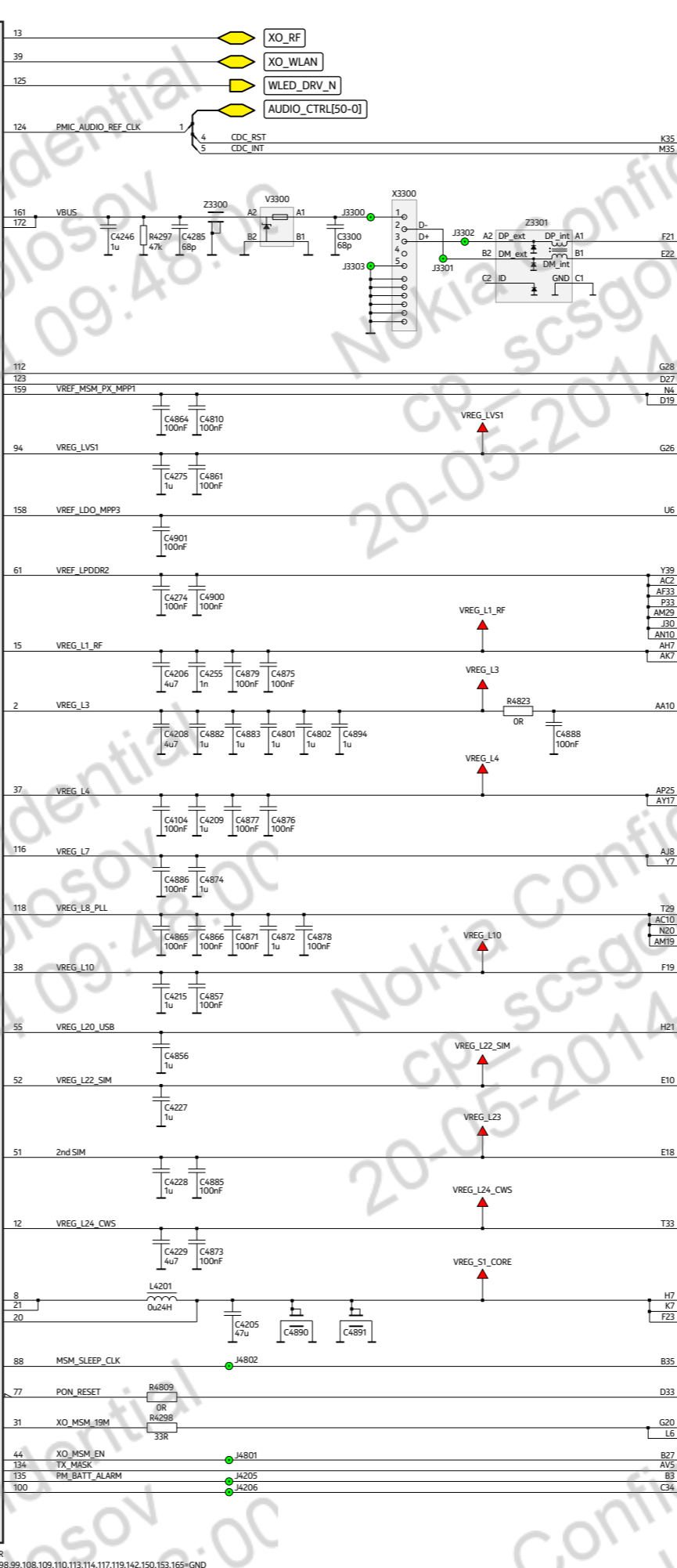

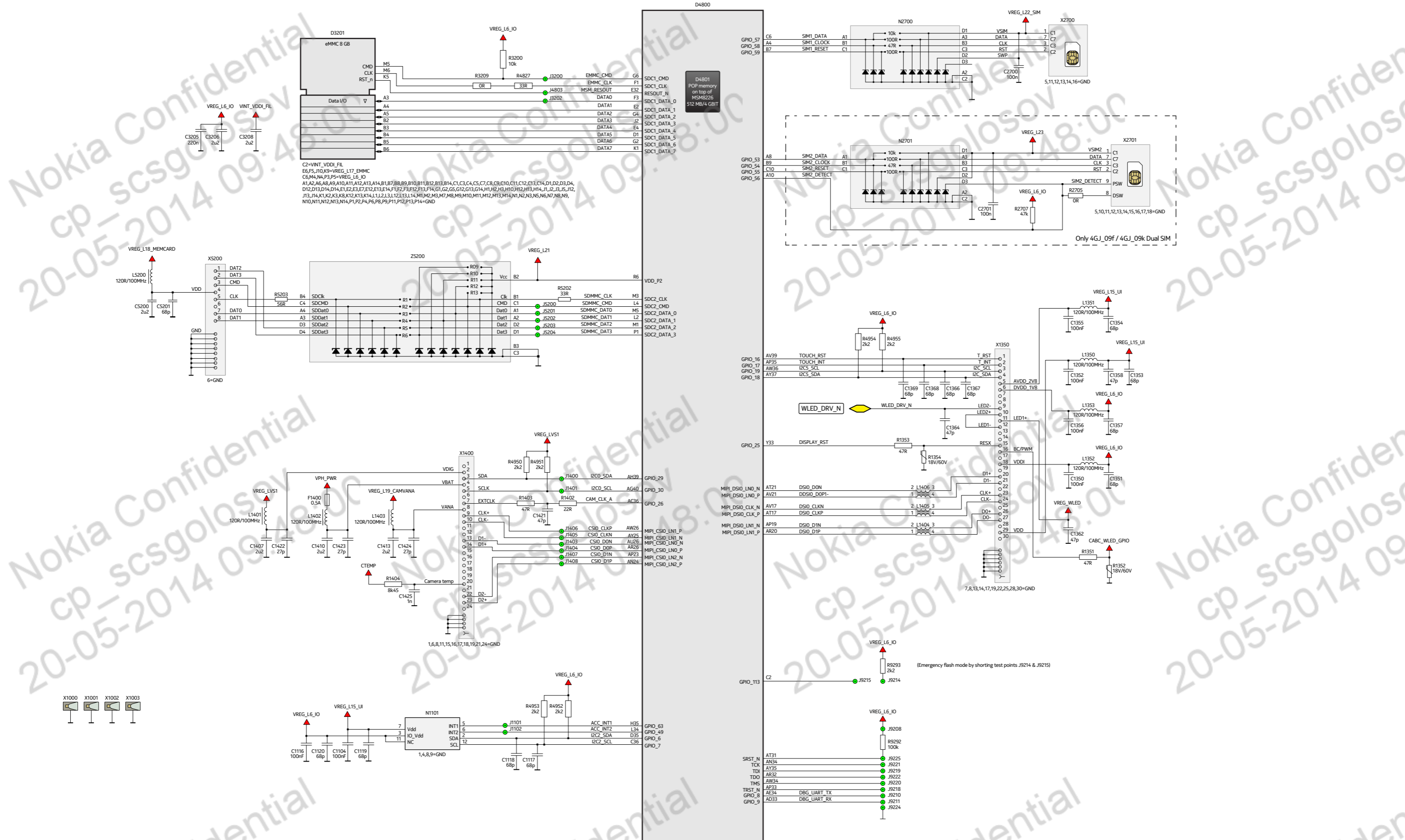

AF39,A12,AM39,AN2,AT39,AU2,AL36,AW16,AW32,AY13,AY21,B19,B23,B33,B37,F39,M39,W38,V39+VREG\_L2\_DORCORE  
 AA12,AA14,AA28,AC18,AC28,AD19,AD23,AD31,AE10,AE26,AE28,AF19,AF23,AF31,AG28,AH11,AH13,AH15,AH17,AH19,AH23,AH31,AJ10,AJ24,AJ28,L30,L14,L32,M23,M25,N22,N26,N32,P27,R20,R22,R30,T27,T21,W12,W18,W20,W20+VREG\_L3  
 A18,A34,A81,AA34,AB39,AC34,AK33,AL8,AM13,AN16,AY7,AY33,B5,C18,H25,H27,H31,J8,J24,J34,V7,Y35+VREG\_L6\_IO  
 A16,AA18,AA22,AA24,AA30,AB21,AB23,AB27,AB29,AC14,AC16,AC24,AC30,AD13,AD15,AD21,AE14,AE16,AE18,AE24,AE30,AE32,AF21,AG18,AG26,AH21,AJ14,AJ20,AJ26,AJ30,AK11,AK13,AK15,AK19,AK21,AL14,AL20,AL26,AL30,AM21,J20,L20,L26,M27,N28,N30,P23,P25,P31,U20,U22,U26,W14,W16,W22,V27,W30,Y23,Y27,Y29+VREG\_S1\_CORE  
 G12,G14,G16,J10,J12,J16,J18,L10,L12,L16,L18,N8,N10,N12,N14,N16,N18,R8,R10,R12,R14,R16,R18,R18,U10,U12,U14,U16,U18,W18,W19+VREG\_S2\_XR  
 A2,AE,A12,A14,A16,A20,A26,A32,A36,A38,A40,AA4,AA8,AA20,AA26,AA32,AA40,AB7,AB9,AB11,AB13,AB15,AB17,AB19,AB25,AB31,AB33,AC4,AC6,AC8,AC12,AC20,AC22,AC26,AC32,AD3,AD5,AD7,AD9,AD11,AD17,AD25,AD27,AD29,AE2,AE4,AE6,AE8,AE12,AE20,AE22,AE36,AE38,AF1,AF3,AF5,AF7,AF9,AF11,AF13,AF15,AF17,AF25,AF27,AG8,AG10,AG16,AG20,AG22,AG24,AG30,AG32,AG36,AG38,AH3,AH5,AH9,AH25,AH27,AH29,AH33,AH37,AJ4,AJ6,AJ12,AJ16,AJ18,AJ22,AJ32,AJ34,AJ38,AK1,AK3,AK5,AK9,AK17,AK23,AK25,AK27,AK29,AK31,AK37,AK39,AL2,AL4,AL6,AL12,AL18,AL22,AL24,AL28,AL32,AL36,AL38,AL40,AM1,AM5,AM7,AM11,AM17,AM25,  
 AM27,AM31,AM33,AM37,AN8,AN12,AN18,AN20,AN22,AN26,AN28,AN32,AN38,AN40,AP5,AP7,AP9,AP17,AP21,AP27,AP31,AP39,AR18,AR28,AR30,AT1,AT9,AT15,AT23,AT25,AT29,AU10,AU14,AU18,AU20,AU24,AU28,AU30,AV13,AV15,AW2,AW4,AW8,AW12,AW18,AV19,AW20,AV23,AW24,AV25,AW30,AW38,AW40,AV9,AY1,AY3,AY19,AY29,AY31,AY39,B1,B11,B13,B15,B17,B21,B25,B39,C8,C12,C14,C16,C20,C30,C32,D7,D9,D11,D13,D15,D17,D21,D29,D31,E12,E14,E16,E20,E30,E34,E36,E38,E40,F9,F11,F13,F15,F17,F33,F37,G8,G10,G18,G30,G32,G36,G38,H1,H3,H5,H9,H11,H13,H15,H17,H19,H23,H29,H33,H37,H39,I6,I14,I22,I26,I28,I32,I36,K5,K9,K11,K13,K15,K17,  
 K19,K21,K23,K25,K27,K29,K31,K33,K37,L22,L24,L28,M7,M9,M11,M13,M15,M17,M19,M21,M29,M31,M33,M37,N2,N6,N4,N36,N40,P3,P7,P9,P11,P13,P15,P17,P19,P21,P29,P37,R4,R24,R26,R28,R32,R36,T7,T9,T11,T13,T15,T17,T19,T21,T25,T31,T35,U28,U30,U36,U40,W24,W26,W28,W33,W32,W34,W36,V5,V11,V13,V15,V17,V19,V21,V25,V29,V31,V33,W6,W9,Y5,Y9,Y11,Y13,Y15,Y17,Y19,Y21,Y25,Y31-GND

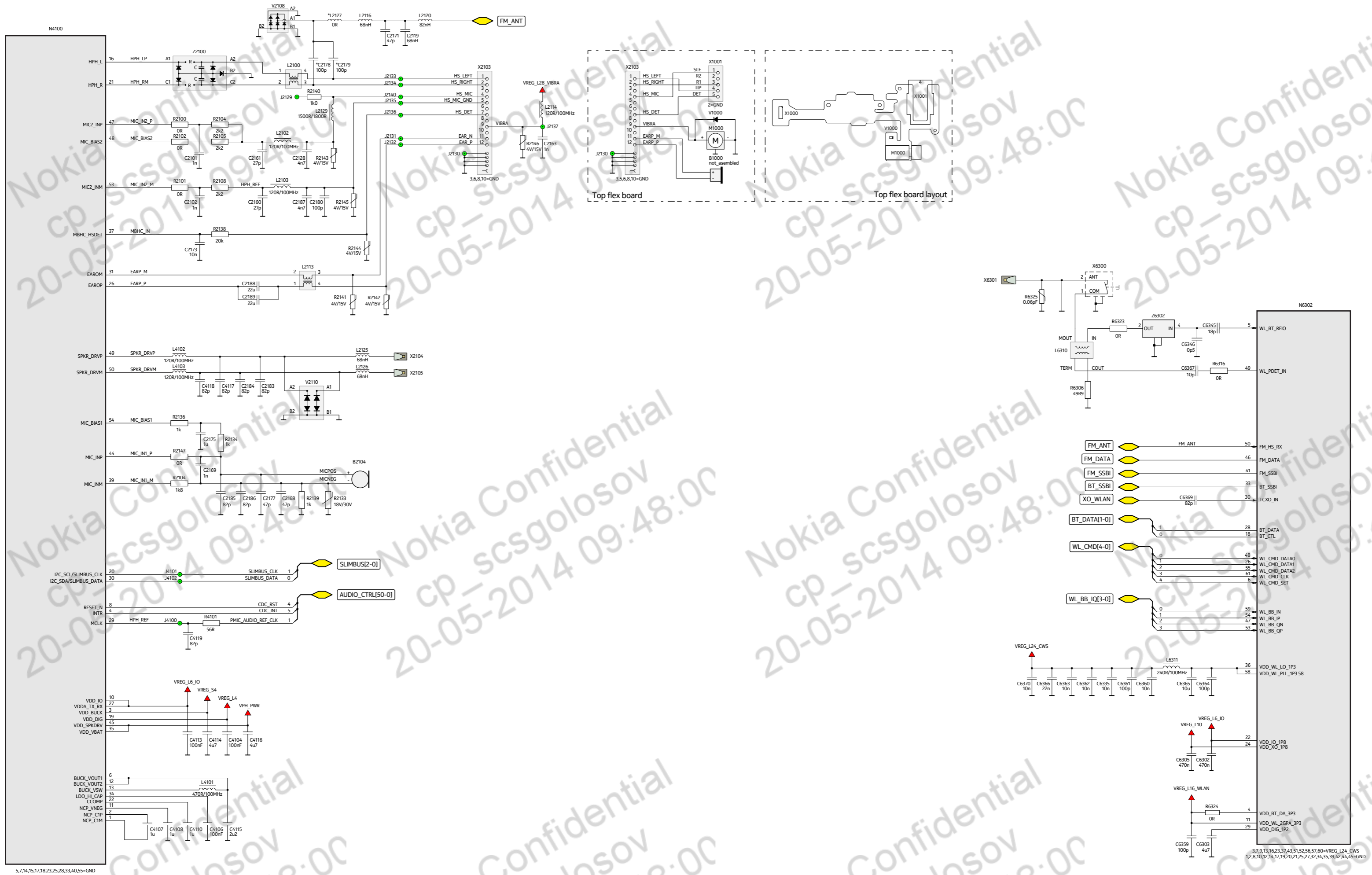

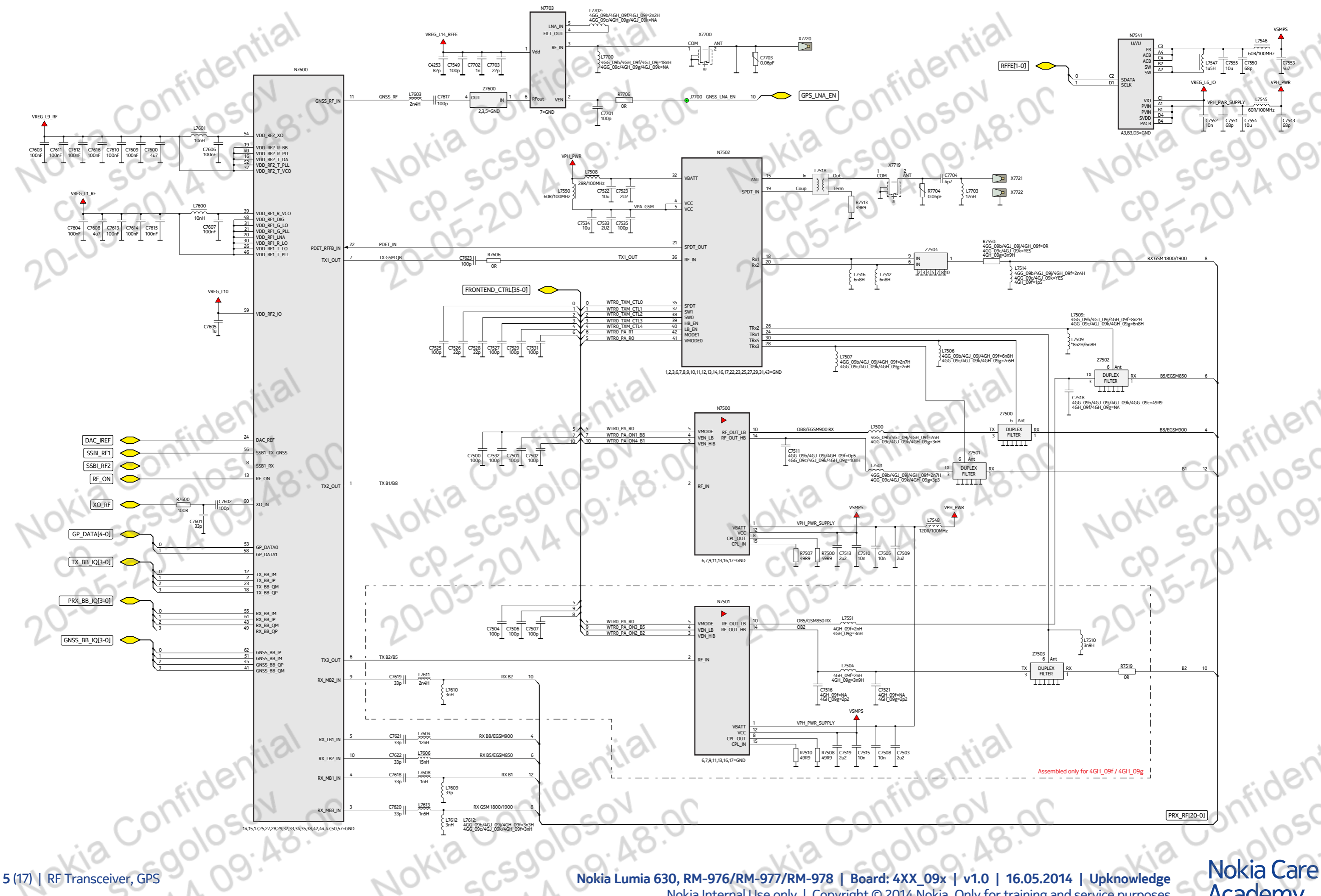

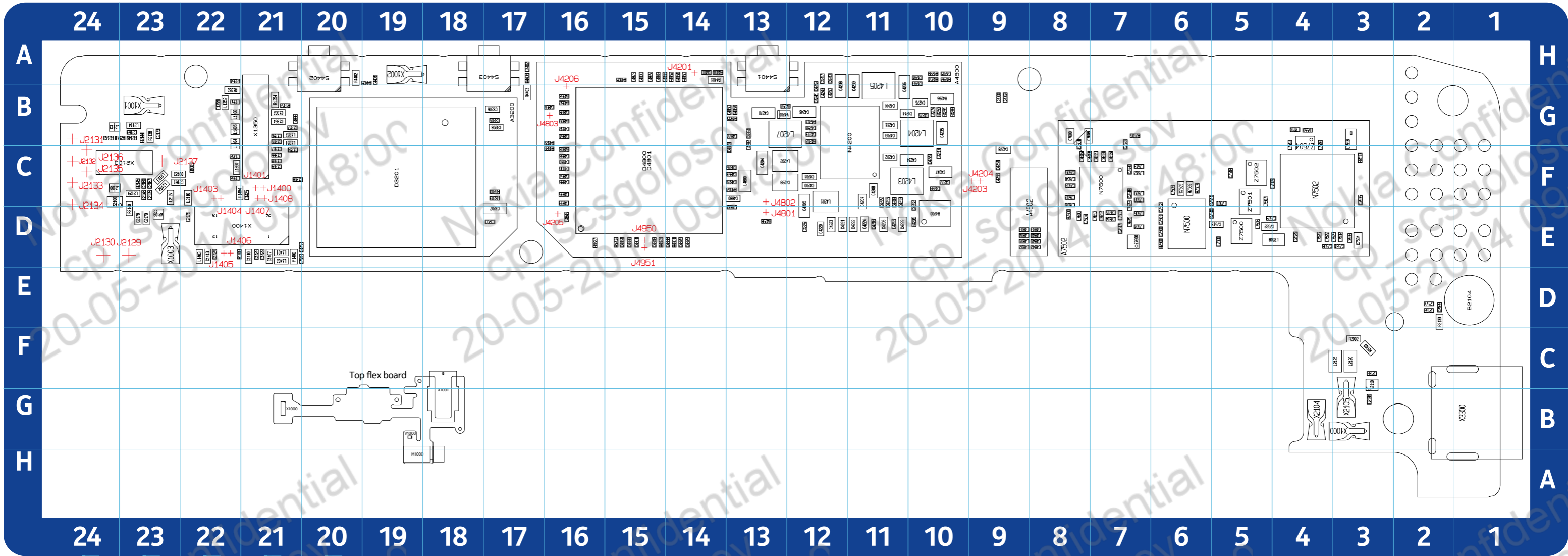

B	C1413	E22	C2187	F23	C4218	E11	C4246	G12	C4284	G13	C4848	E15	C7501	E6	C7600	G8	C7622	F7	L2103	F23	L7506	E5	N7600	F7	R3209	F17	R4803	F16	R7600	E8	Z	J2130	E24		
B2104	D1	C1422	E21	C3203	E17	C4219	F11	C4247	F10	C4285	H10	C4849	H15	C7502	E6	C7601	F8	C7623	G7	L2113	G24	L7507	F5	R	R4201	E10	R4805	H15	R7606	G7	Z2100	F24	J2131	G24	
B4200	E10	C1423	E21	C3205	G17	C4220	E12	C4249	G12	C4400	H14	C4850	G13	C7505	F6	C7602	F8	D	L2114	G23	L7508	E4	R1001	F22	R4202	G12	R4809	G16	S	Z4200	E12	J2132	F24		
C	C1424	E22	C3206	G17	C4221	E12	C4250	G12	C4401	H19	C4853	F13	C7509	F6	C7603	F8	D3201	F19	L2116	F22	L7509	F4	R1351	H22	R4203	G12	R4823	E15	S4401	H13	Z4201	F12	J2133	F24	
C1350	G22	C1425	F21	C3207	E17	C4222	E11	C4252	F10	C4402	H17	C4856	F16	C7510	E6	C7604	F8	D4800	F15	L2125	C3	L7512	G4	R1352	G22	R4250	G10	R4827	E16	S4402	H20	Z4202	F11	J2134	F24
C1351	G22	C2000	G9	C3208	G17	C4223	E12	C4253	E21	C4810	F16	C4857	F16	C7511	F6	C7605	F8	D4801	F15	L2126	C3	L7514	G4	R1353	G21	R4251	H10	R4828	F16	S4403	H17	Z4203	G10	J2135	F24
C1352	F22	C2002	G9	C4200	F12	C4224	E11	C4254	F9	C4823	F13	C4861	G16	C7513	E5	C7606	F8	F	L2127	F23	L7516	G4	R1354	G21	R4266	G10	R4829	G16	V	Z7500	E5	J2136	F24		
C1353	F22	C2128	F23	C4201	F12	C4226	E12	C4255	F9	C4826	E15	C4864	E15	C7518	F5	C7607	E8	F1400	E21	L2129	F23	L7518	G3	R1403	E22	R4289	G10	R4950	H14	V2108	E23	Z7501	F5	J2137	F23
C1354	F21	C2160	F23	C4202	F11	C4227	F11	C4257	H12	C4827	H15	C4873	H15	C7522	E5	C7608	G8	L	L4201	F12	L7600	E8	R1404	F22	R4291	G10	R4951	H14	V2110	C3	Z7502	F5	J4201	H14	
C1355	G21	C2161	F23	C4203	G11	C4228	F10	C4258	G12	C4828	G16	C4875	E14	C7523	E5	C7609	F8	L1350	F22	L4202	F13	L7601	G8	R2000	C3	R4292	H10	R4952	G16	V4200	G13	Z7504	G4	J4203	F9
C1356	G21	C2163	G23	C4204	F13	C4229	E11	C4270	G13	C4829	F13	C4876	F13	C7525	E4	C7610	E7	L1351	G21	L4203	F11	L7603	E7	R2002	C3	R4297	G13	R4953	G16	X	Z7600	E7	J4204	F9	
C1357	G21	C2168	D2	C4205	F12	C4233	F13	C4273	G12	C4830	E13	C4877	G13	C7526	E4	C7611	F7	L1352	G22	L4204	G10	L7604	E7	R2133	D2	R4298	E13	R4954	G13	X1000	B3	TST points	J4205	E16	
C1358	F21	C2169	D2	C4206	E11	C4234	F10	C4274	G10	C4832	G16	C4879	E14	C7527	E4	C7612	E7	L1353	G21	L4205	G11	L7606	E7	R2138	G23	R4299	H10	R4955	G13	X1001	G23	J1400	F21	J4206	G16
C1362	G21	C2171	E22	C4207	F11	C4235	G10	C4275	G10	C4833	F16	C4880	F13	C7528	E4	C7613	F7	L1401	E21	L4207	G13	L7608	F7	R2140	E23	R4401	H14	R4956	H15	X1002	H19	J1401	F21	J4801	E13
C1364	G21	C2173	G23	C4208	F11	C4236	G11	C4276	G10	C4835	F16	C4885	F16	C7529	E3	C7614	E7	L1402	E21	L4800	F13	L7609	F7	R2141	G23	R4402	H20	R4957	H14	X1003	E23	J1403	F22	J4802	F13
C1366	F21	C2177	D2	C4209	F11	C4238	G12	C4277	F10	C4836	F16	C4888	E14	C7531	E3	C7615	E7	L1403	E22	L4801	E9	L7612	F7	R2142	G24	R4403	G17	R5202	E15	X1350	G21	J1404	F22	J4803	G16
C1367	F21	C2178	E23	C4211	G11	C4239	G11	C4278	F9	C4841	E8	C4897	G16	C7532	E3	C7616	F7	L1404	G22	L4802	E9	L7613	F7	R2143	F23	R4404	H14	R7500	E6	X1400	E21	J1405	E22	J4950	E15
C1368	F21	C2179	E23	C4214	G11	C4241	G12	C4279	F10	C4842	E8	C4898	G21	C7533	E3	C7617	E7	L1405	G22	L4803	E9	N	R2144	G23	R4405	H19	R7507	F6	X2103	F23	J1406	E22	J4951	E15	
C1369	F21	C2180	F23	C4215	F11	C4242	G12	C4281	H10	C4843	E8	C4900	H15	C7534	E3	C7618	F7	L1406	G22	L4804	E9	N4200	G11	R2145	F23	R4406	H17	R7513	F3	X2104	B4	J1407	F21		
C1407	E21	C2183	C3	C4216	E11	C4243	H12	C4282	G13	C4844	E8	C4901	E15	C7535	F3	C7620	F7	L2100	F24	L7500	E5	N7500	E6	R2146	G23	R4801	E14	R7550	G4	X2105	B3	J1408	F21		
C1410	E21	C2184	B3	C4217	F10	C4244	G11	C4283	H10	C4846	E16	C7500	E6	C7549	E21	C7621	E7	L2102	F23	L7501	F5	N7502	F4	R3200	F17	R4802	F13	R7569	F6	X3300	B1	J2129	E23		

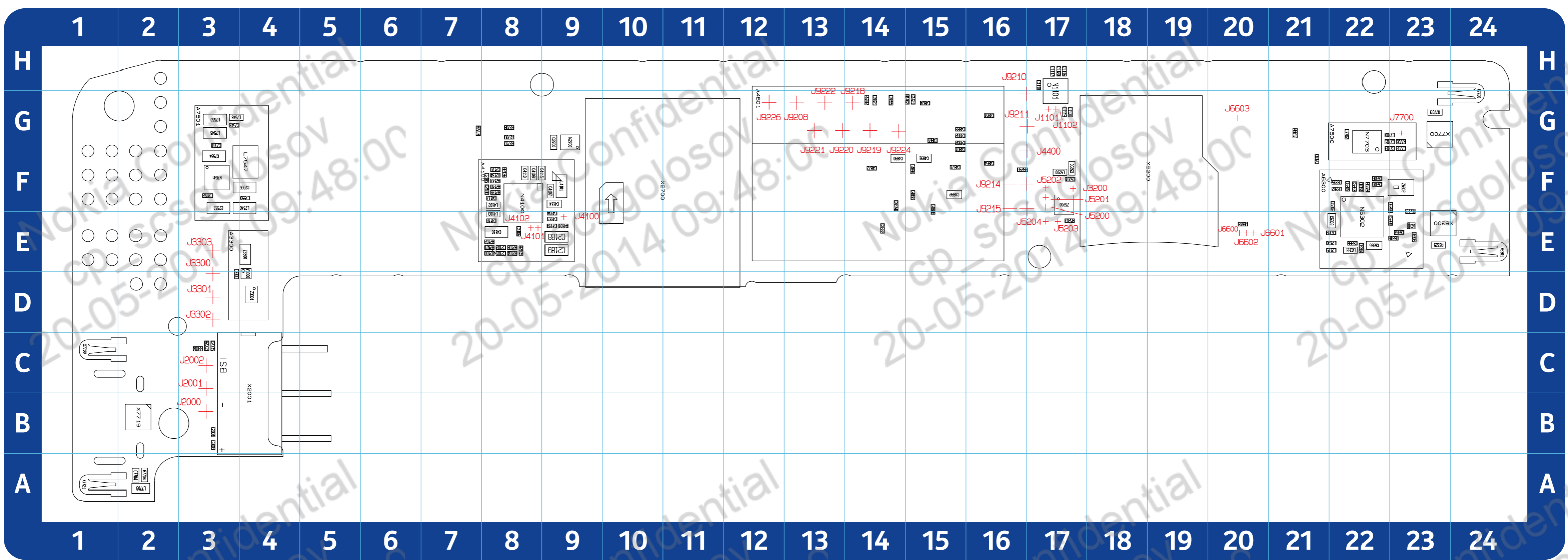

C	C4106	E8	C4871	F15	C6362	F22	L2120	E22	N7703	G22	R5203	E17	X7700	G23	J3301	D3	J9215	F17	
C1104	G17	C4107	F9	C4872	F14	C6363	F22	L4101	F9	R	R6306	E23	X7719	B2	J3302	D3	J9218	G14	
C1116	H17	C4108	F8	C4874	F14	C6364	E22	L4102	F8	R1402	G15	R6316	E23	X7720	G24	J3303	E3	J9219	G14
C1117	H17	C4110	F8	C4882	G15	C6365	E22	L4103	E8	R2003	C3	R6323	F23	X7721	A1	J4100	E9	J9220	G13
C1118	H17	C4113	E9	C4883	G15	C6366	E22	L5200	F17	R2004	C3	R6324	F22	X7722	C1	J4101	E8	J9221	G13
C1119	G17	C4114	F9	C4886	F15	C6367	E23	L6310	E23	R2100	E8	R6325	E23	Z	J4102	E8	J9222	G13	
C1120	H17	C4115	F9	C4890	F14	C6369	E22	L6311	E22	R2101	E8	R6617	G21	Z3300	E4	J4400	G17	J9224	G14
C1421	G15	C4116	E8	C4891	F15	C6370	F21	L7545	G3	R2102	E8	R6618	E20	Z3301	D4	J5200	F17	J9225	G12
C2001	B3	C4117	F8	C4892	F15	C7543	G3	L7546	F4	R2104	E8	R7703	G23	Z4204	B3	J5201	F17		
C2003	B3	C4118	E8	C4894	F15	C7550	F4	L7547	F4	R2105	E8	R7704	A2	Z5200	F17	J5202	F17		
C2005	C3	C4119	E9	C5200	F17	C7551	G3	L7548	G3	R2108	E8	R7706	G23	Z6302	F23	J5203	E17		
C2101	E8	C4801	G15	C5201	F17	C7552	F3	L7550	G3	R2134	F8	R9292	G14	Z6303	E24	J5204	E17		
C2102	E8	C4802	G15	C6302	F22	C7553	F3	L7700	G23	R2136	F8	R9293	F16	Z7700	H23	J6600	E20		
C2175	F8	C4821	G14	C6303	E22	C7554	F3	L7702	G22	R2139	F8	V	TST points	J6601	E20				
C2185	F8	C4822	E14	C6305	F22	C7555	F4	L7703	A2	R2147	F8	V3300	D4	J1101	G17	J6602	E20		
C2186	F8	C4824	G15	C6335	F22	C7701	G23	N	R2148	F8	X	J1102	G17	J6603	G20				
C2188	E9	C4851	G16	C6345	F22	C7702	G23	N1101	G17	R2707	G7	X2001	B4	J2000	B3	J7700	G23		
C2189	E9	C4854	F16	C6346	F22	C7703	G23	N2700	G9	R2708	G8	X2700	F10	J2001	C3	J9208	G13		
C2700	G9	C4855	G14	C6359	F23	C7704	A2	N4100	F8	R2709	G8	X5200	F19	J2002	C3	J9210	G17		
C3300	D3	C4865	G15	C6360	E23	L	N6302	E22	R2710	G8	X6300	E23	J3200	F17	J9211	G17			
C4104	E9	C4866	F15	C6361	F22	L2119	E22	N7541	F3	R4101	E9	X6301	E24	J3300	D3	J9214	F17		



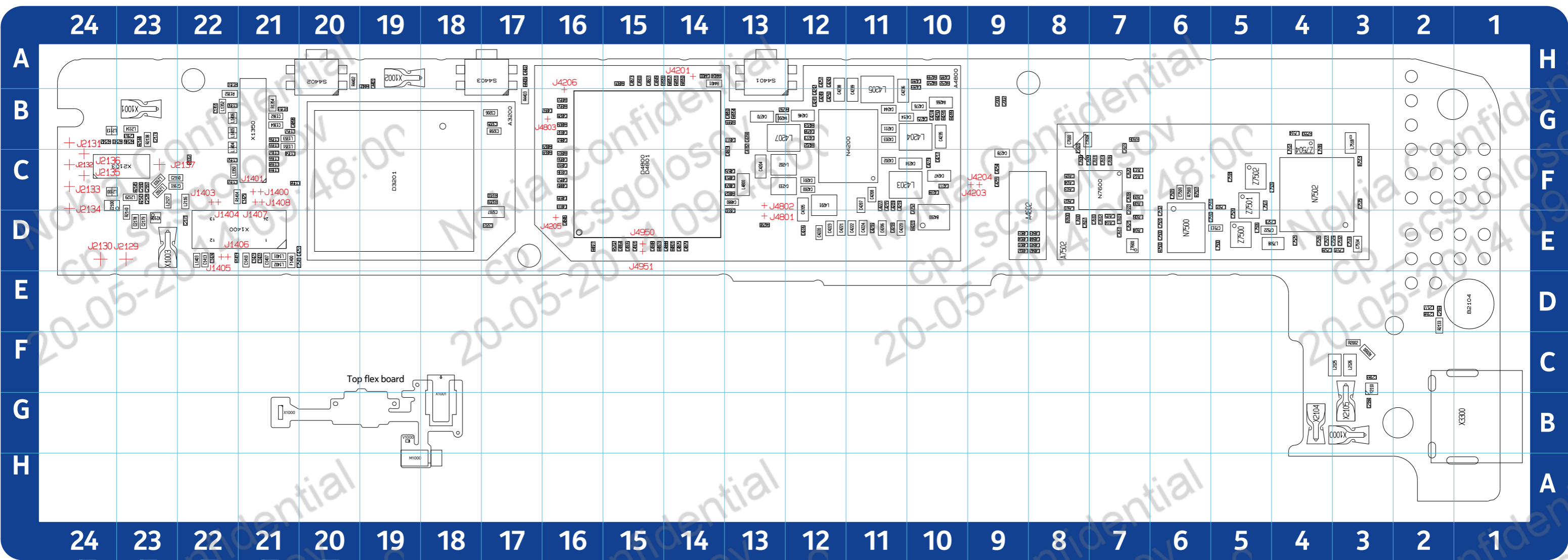

	24	23	22	21	20	19	18	17	16	15	14	13	12	11	10	9	8	7	6	5	4	3	2	1											
<b>B</b>	C1413	E22	C2187	F23	C4218	E11	C4246	G12	C4284	G13	C4848	E15	C7501	E6	C7549	E21	C7621	E7	L2102	F23	L7501	F5	N7502	F4	R3200	F17	R4802	F13	R7569	F6	X3300	B1	J2129	E23	
B2104	D1	C1422	E21	C3203	E17	C4219	F11	C4247	F10	C4285	H10	C4849	H15	C7502	E6	C7600	G8	C7622	F7	L2103	F23	L7506	E5	N7600	F7	R3209	F17	R4803	F16	R7600	E8	<b>Z</b>	J2130	E24	
B4200	E10	C1423	E21	C3205	G17	C4220	E12	C4249	G12	C4400	H14	C4850	G13	C7505	F6	C7601	F8	C7623	G7	L2113	G24	L7507	F5	<b>R</b>	R4201	E10	R4805	H15	R7606	G7	Z2100	F24	J2131	G24	
<b>C</b>	C1424	E22	C3206	G17	C4221	E12	C4250	G12	C4401	H19	C4853	F13	C7509	F6	C7602	F8	<b>D</b>	L2114	G23	L7508	E4	R1002	F22	R4202	G12	R4809	G16	<b>S</b>	Z4200	E12	J2132	F24			
C1350	G22	C1425	F21	C3207	E17	C4222	E11	C4252	F10	C4402	H17	C4856	F16	C7510	E6	C7603	F8	D3201	F19	L2116	F22	L7509	F4	R1351	H22	R4203	G12	R4823	E15	S4401	H13	Z4201	F12	J2133	F24
C1351	G22	C2000	G9	C3208	G17	C4223	E12	C4253	E21	C4810	F16	C4857	F16	C7511	F6	C7604	F8	D4800	F15	L2125	C3	L7512	G4	R1352	G22	R4250	G10	R4827	E16	S4402	H20	Z4202	F11	J2134	F24
C1352	F22	C2002	G9	C4200	F12	C4224	E11	C4254	F9	C4823	F13	C4861	G16	C7513	E5	C7605	F8	D4801	F15	L2126	C3	L7514	G4	R1353	G21	R4251	H10	R4828	F16	S4403	H17	Z4203	G10	J2135	F24
C1353	F22	C2128	F23	C4201	F12	C4226	E12	C4255	F9	C4826	E15	C4864	E15	C7518	F5	C7606	F8	<b>F</b>	L2127	F23	L7516	G4	R1354	G21	R4266	G10	R4829	G16	<b>V</b>	Z7500	E5	J2136	F24		
C1354	F21	C2160	F23	C4202	F11	C4227	F11	C4257	H12	C4827	H15	C4873	H15	C7520	E5	C7607	E8	F1400	E21	L2129	F23	L7518	G3	R1403	E22	R4289	G10	R4950	H14	V2108	E23	Z7501	F5	J2137	F23
C1355	G21	C2161	F23	C4203	G11	C4228	F10	C4258	G12	C4828	G16	C4875	E14	C7522	E5	C7608	G8	<b>L</b>	L4201	F12	L7600	E8	R1404	F22	R4291	G10	R4951	H14	V2110	C3	Z7502	F5	J4201	H14	
C1356	G21	C2163	G23	C4204	F13	C4229	E11	C4270	G13	C4829	F13	C4876	F13	C7523	E5	C7609	F8	L1350	F22	L4202	F13	L7601	G8	R2000	C3	R4292	H10	R4952	G16	V4200	G13	Z7504	G4	J4203	F9
C1357	G21	C2168	D2	C4205	F12	C4233	F13	C4273	G12	C4830	E13	C4877	G13	C7525	E4	C7610	E7	L1351	G21	L4203	F11	L7603	E7	R2002	C3	R4297	G13	R4953	G16	<b>X</b>	Z7600	E7	J4204	F9	
C1358	F21	C2169	D2	C4206	E11	C4234	F10	C4274	G10	C4832	G16	C4879	E14	C7526	E4	C7611	F7	L1352	G22	L4204	G10	L7604	E7	R2133	D2	R4298	E13	R4954	G13	X1000	<b>B3</b>	<b>TST points</b>	J4205	E16	
C1362	G21	C2171	E22	C4207	F11	C4235	G10	C4275	G10	C4833	F16	C4880	F13	C7527	E4	C7612	E7	L1353	G21	L4205	G11	L7606	E7	R2138	G23	R4299	H10	R4955	G13	X1001	G23	J1400	F21	J4206	G16
C1364	G21	C2173	G23	C4208	F11	C4236	G11	C4276	G10	C4835	F16	C4885	F16	C7528	E4	C7613	F7	L1401	E21	L4207	G13	L7608	F7	R2140	E23	R4401	H14	R4956	H15	X1002	H19	J1401	F21	J4801	E13
C1366	F21	C2177	D2	C4209	F11	C4238	G12	C4277	F10	C4836	F16	C4888	E14	C7529	E3	C7614	E7	L1402	E21	L4800	F13	L7609	F7	R2141	G23	R4402	H20	R4957	H14	X1003	E23	J1403	F22	J4802	F13
C1367	F21	C2178	E23	C4211	G11	C4239	G11	C4278	F9	C4841	E8	C4897	G16	C7531	E3	C7615	E7	L1403	E22	L4801	E9	L7612	F7	R2142	G24	R4403	G17	R5202	E15	X1350	G21	J1404	F22	J4803	G16
C1368	F21	C2179	E23	C4214	G11	C4241	G12	C4279	F10	C4842	E8	C4898	G21	C7532	E3	C7616	F7	L1404	G22	L4802	E9	L7613	F7	R2143	F23	R4404	H14	R7500	E6	X1400	E21	J1405	E22	J4950	E15
C1369	F21	C2180	F23	C4215	F11	C4242	G12	C4281	H10	C4843	E8	C4900	H15	C7533	E3	C7617	E7	L1405	G22	L4803	E9	<b>N</b>	R2144	G23	R4405	H19	R7507	F6	X2103	F23	J1406	E22	J4951	E15	
C1407	E21	C2183	C3	C4216	E11	C4243	H12	C4282	G13	C4844	E8	C4901	E15	C7534	E3	C7618	F7	L1406	G22	L4804	E9	N4200	G11	R2145	F23	R4406	H17	R7513	F3	X2104	B4	J1407	F21		
C1410	E21	C2184	B3	C4217	F10	C4244	G11	C4283	H10	C4846	E16	C7500	E6	C7535	F3	C7620	F7	L2100	F24	L7500	E5	N7500	E6	R2146	G23	R4801	E14	R7550	G4	X2105	B3	J1408	F21		

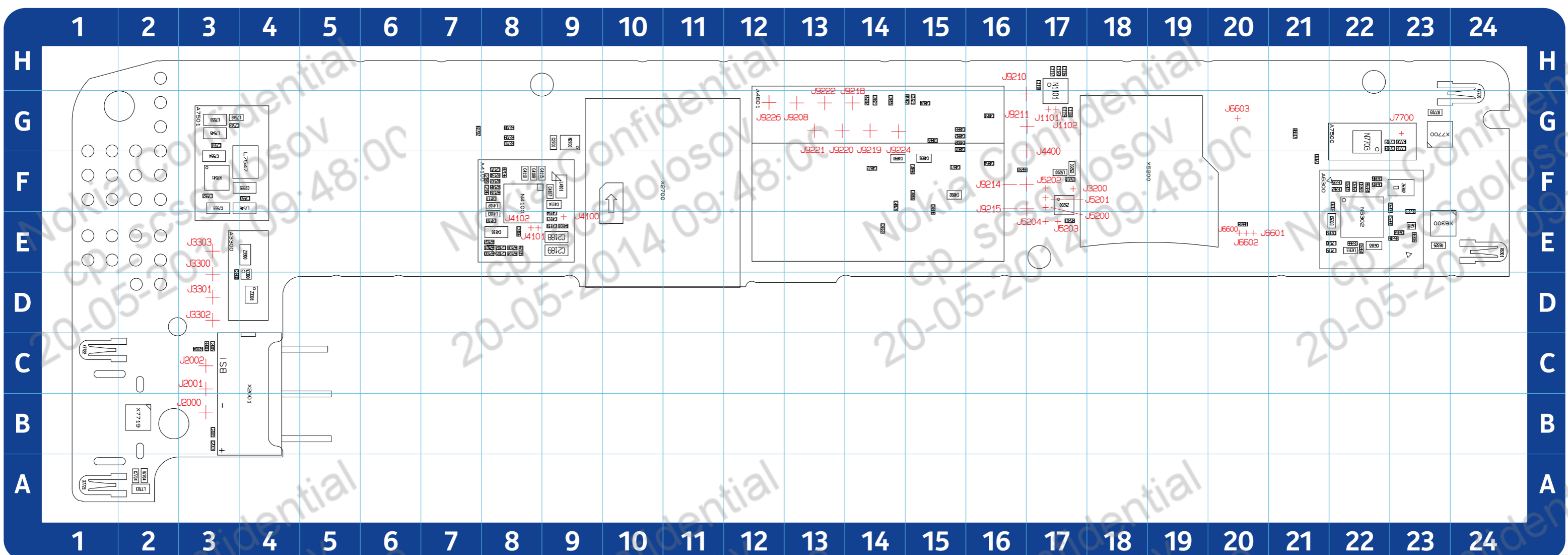

C	C4106	E8	C4871	F15	C6362	F22	L2120	E22	R1402	G15	R6316	E23	X7720	G24	J3303	E3	J9219	G14	
C1104	G17	C4107	F9	C4872	F14	C6363	F22	L4101	F9	R2003	C3	R6323	F23	X7721	A1	J4100	E9	J9220	G13
C1116	H17	C4108	F8	C4874	F14	C6364	E22	L4102	F8	R2004	C3	R6324	F22	X7722	C1	J4101	E8	J9221	G13
C1117	H17	C4110	F8	C4882	G15	C6365	E22	L4103	E8	R2100	E8	R6325	E23	Z	J4102	E8	J9222	G13	
C1118	H17	C4113	E9	C4883	G15	C6366	E22	L5200	F17	R2101	E8	R6617	G21	Z3300	E4	J4400	G17	J9224	G14
C1119	G17	C4114	F9	C4886	F15	C6367	E23	L6310	E23	R2102	E8	R6618	E20	Z3301	D4	J5200	F17	J9225	G12
C1120	H17	C4115	F9	C4890	F14	C6369	E22	L6311	E22	R2104	E8	R7703	G23	Z4204	B3	J5201	F17		
C1421	G15	C4116	E8	C4891	F15	C6370	F21	L7545	G3	R2105	E8	R7704	A2	Z5200	F17	J5202	F17		
C2001	B3	C4117	F8	C4892	F15	C7543	G3	L7546	F4	R2108	E8	R7706	G23	Z6302	F23	J5203	E17		
C2003	B3	C4118	E8	C4894	F15	C7550	F4	L7547	F4	R2134	F8	R9292	G14	Z6303	E24	J5204	E17		
C2005	C3	C4119	E9	C5200	F17	C7551	G3	L7548	G3	R2136	F8	R9293	F16	Z7700	H23	J6600	E20		
C2101	E8	C4801	G15	C5201	F17	C7552	F3	L7550	G3	R2139	F8	V	TST points	J6601	E20				
C2102	E8	C4802	G15	C6302	F22	C7553	F3	L7703	A2	R2147	F8	V3300	D4	J1101	G17	J6602	E20		
C2175	F8	C4821	G14	C6303	E22	C7554	F3	N	R2148	F8	X	J1102	G17	J6603	G20				
C2185	F8	C4822	E14	C6305	F22	C7555	F4	N1101	G17	R2707	G7	X2001	B4	J2000	B3	J7700	G23		
C2186	F8	C4824	G15	C6335	F22	C7701	G23	N2700	G9	R2708	G8	X2700	F10	J2001	C3	J9208	G13		
C2188	E9	C4851	G16	C6345	F22	C7702	G23	N4100	F8	R2709	G8	X5200	F19	J2002	C3	J9210	G17		
C2189	E9	C4854	F16	C6346	F22	C7703	G23	N6302	E22	R2710	G8	X6300	E23	J3200	F17	J9211	G17		
C2700	G9	C4855	G14	C6359	F23	C7704	A2	N7541	F3	R4101	E9	X6301	E24	J3300	D3	J9214	F17		
C3300	D3	C4865	G15	C6360	E23	L	N7703	G22	R5203	E17	X7700	G23	J3301	D3	J9215	F17			
C4104	E9	C4866	F15	C6361	F22	L2119	E22	R	R6306	E23	X7719	B2	J3302	D3	J9218	G14			

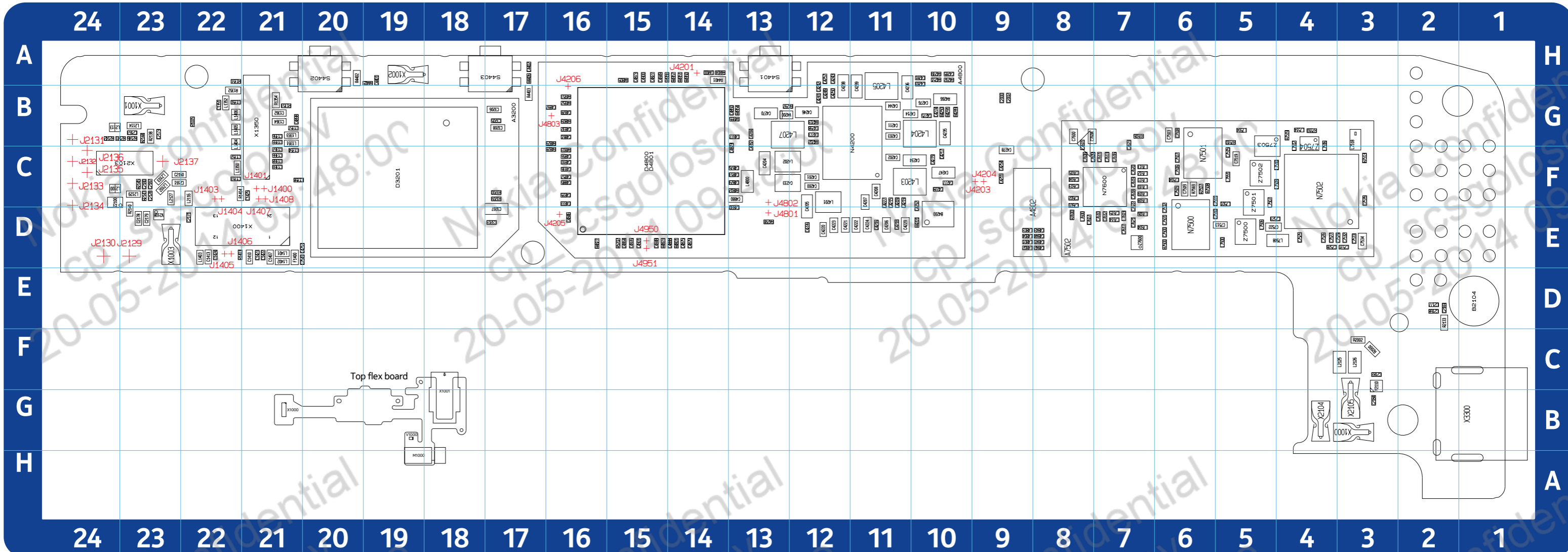

	24	23	22	21	20	19	18	17	16	15	14	13	12	11	10	9	8	7	6	5	4	3	2	1													
B	C1413	E22	C2187	F23	C4218	E11	C4246	G12	C4284	G13	C4848	E15	C7501	E6	C7531	E3	C7615	E7	L1402	E21	L4800	F13	L7604	E7	R1404	F22	R4291	G10	R4951	H14	S4403	H17	Z4203	G10	J2134	F24	
B2104	D1	C1422	E21	C3203	E17	C4219	F11	C4247	F10	C4285	H10	C4849	H15	C7502	E6	C7532	E3	C7616	F7	L1403	E22	L4801	E9	L7606	E7	R2000	C3	R4292	H10	R4952	G16	V	Z7500	E5	J2135	F24	
B4200	E10	C1423	E21	C3205	G17	C4220	E12	C4249	G12	C4400	H14	C4850	G13	C7503	G6	C7533	E3	C7617	E7	L1404	G22	L4802	E9	L7608	F7	R2002	C3	R4297	G13	R4953	G16	V2108	E23	Z7501	F5	J2136	F24
C	C1424	E22	C3206	G17	C4221	E12	C4250	G12	C4401	H19	C4853	F13	C7504	F6	C7534	E3	C7618	F7	L1405	G22	L4803	E9	L7609	F7	R2133	D2	R4298	E13	R4954	G13	V2110	C3	Z7502	F5	J2137	F23	
C1350	G22	C1425	F21	C3207	E17	C4222	E11	C4252	F10	C4402	H17	C4856	F16	C7505	F6	C7535	F3	C7619	F7	L1406	G22	L4804	E9	L7610	F7	R2138	G23	R4299	H10	R4955	G13	V4200	G13	Z7503	G5	J4201	H14
C1351	G22	C2000	G9	C3208	G17	C4223	E12	C4253	E21	C4810	F16	C4857	F16	C7506	F6	C7549	E21	C7620	F7	L2100	F24	L7500	E5	L7611	F7	R2140	E23	R4401	H14	R4956	H15	X	Z7504	G4	J4203	F9	
C1352	F22	C2002	G9	C4200	F12	C4224	E11	C4254	F9	C4823	F13	C4861	G16	C7507	F6	C7600	G8	C7621	E7	L2102	F23	L7501	F5	L7612	F7	R2141	G23	R4402	H20	R4957	H14	X1000	B3	Z7600	E7	J4204	F9
C1353	F22	C2128	F23	C4201	F12	C4226	E12	C4255	F9	C4826	E15	C4864	E15	C7508	G6	C7601	F8	C7622	F7	L2103	F23	L7504	G5	L7613	F7	R2142	G24	R4403	G17	R5202	E15	X1001	G23	TST points	J4205	E16	
C1354	F21	C2160	F23	C4202	F11	C4227	F11	C4257	H12	C4827	H15	C4873	H15	C7509	F6	C7602	F8	C7623	G7	L2113	G24	L7506	E5	N	R2143	F23	R4404	H14	R7500	E6	X1002	H19	J1400	F21	J4206	G16	
C1355	G21	C2161	F23	C4203	G11	C4228	F10	C4258	G12	C4828	G16	C4875	E14	C7510	E6	C7603	F8	D	L2114	G23	L7507	F5	N4200	G11	R2144	G23	R4405	H19	R7507	F6	X1003	E23	J1401	F21	J4801	E13	
C1356	G21	C2163	G23	C4204	F13	C4229	E11	C4270	G13	C4829	F13	C4876	F13	C7511	F6	C7604	F8	D3201	F19	L2116	F22	L7508	E4	N7500	E6	R2145	F23	R4406	H17	R7508	F6	X1350	G21	J1403	F22	J4802	F13
C1357	G21	C2168	D2	C4205	F12	C4233	F13	C4273	G12	C4830	E13	C4877	G13	C7513	E5	C7605	F8	D4800	F15	L2125	C3	L7509	F4	N7501	F6	R2146	G23	R4801	E14	R7510	G5	X1400	E21	J1404	F22	J4803	G16
C1358	F21	C2169	D2	C4206	E11	C4234	F10	C4274	G10	C4832	G16	C4879	E14	C7515	F5	C7606	F8	D4801	F15	L2126	C3	L7510	F4	N7502	F4	R3200	F17	R4802	F13	R7513	F3	X2103	F23	J1405	E22	J4950	E15
C1362	G21	C2171	E22	C4207	F11	C4235	G10	C4275	G10	C4833	F16	C4880	F13	C7519	F5	C7607	E8	F	L2127	F23	L7512	G4	N7600	F7	R3209	F17	R4803	F16	R7519	G4	X2104	B4	J1406	E22	J4951	E15	
C1364	G21	C2173	G23	C4208	F11	C4236	G11	C4276	G10	C4835	F16	C4885	F16	C7522	E5	C7608	G8	F1400	E21	L2129	F23	L7514	G4	R	R4201	E10	R4805	H15	R7550	G4	X2105	B3	J1407	F21			
C1366	F21	C2177	D2	C4209	F11	C4238	G12	C4277	F10	C4836	F16	C4888	E14	C7523	E5	C7609	F8	L	L4201	F12	L7516	G4	R1005	G22	R4202	G12	R4809	G16	R7569	F6	X3300	B1	J1408	F21			
C1367	F21	C2178	E23	C4211	G11	C4239	G11	C4278	F9	C4841	E8	C4897	G16	C7525	E4	C7610	E7	L1350	F22	L4202	F13	L7518	G3	R1351	H22	R4203	G12	R4823	E15	R7600	E8	Z	J2129	E23			
C1368	F21	C2179	E23	C4214	G11	C4241	G12	C4279	F10	C4842	E8	C4898	G21	C7526	E4	C7611	F7	L1351	G21	L4203	F11	L7551	F5	R1352	G22	R4250	G10	R4827	E16	R7606	G7	Z2100	F24	J2130	E24		
C1369	F21	C2180	F23	C4215	F11	C4242	G12	C4281	H10	C4843	E8	C4900	H15	C7527	E4	C7612	E7	L1352	G22	L4204	G10	L7600	E8	R1353	G21	R4251	H10	R4828	F16	S	Z4200	E12	J2131	G24			
C1407	E21	C2183	C3	C4216	E11	C4243	H12	C4282	G13	C4844	E8	C4901	E15	C7528	E4	C7613	F7	L1353	G21	L4205	G11	L7601	G8	R1354	G21	R4266	G10	R4829	G16	S4401	H13	Z4201	F12	J2132	F24		
C1410	E21	C2184	B3	C4217	F10	C4244	G11	C4283	H10	C4846	E16	C7500	E6	C7529	E3	C7614	E7	L1401	E21	L4207	G13	L7603	E7	R1403	E22	R4289	G10	R4950	H14	S4402	H20	Z4202	F11	J2133	F24		

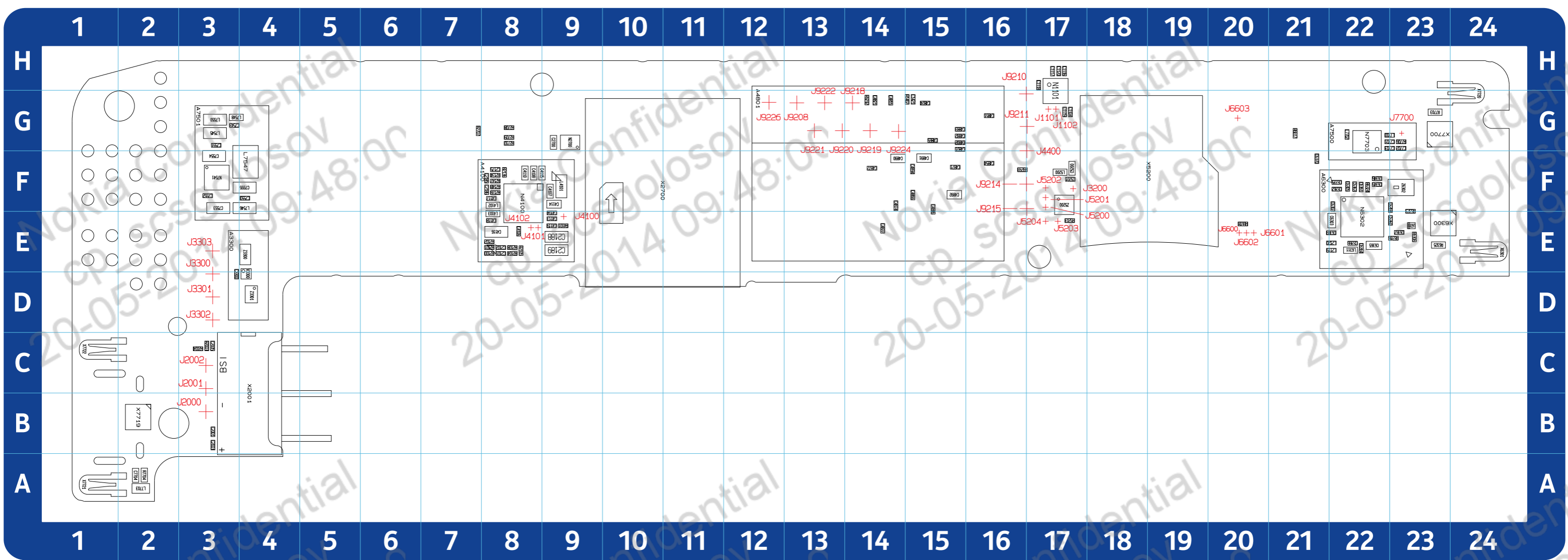

C	C4106	E8	C4871	F15	C6362	F22	L2120	E22	N7703	G22	R5203	E17	X7700	G23	J3301	D3	J9215	F17	
C1104	G17	C4107	F9	C4872	F14	C6363	F22	L4101	F9	R	R6306	E23	X7719	B2	J3302	D3	J9218	G14	
C1116	H17	C4108	F8	C4874	F14	C6364	E22	L4102	F8	R1402	G15	R6316	E23	X7720	G24	J3303	E3	J9219	G14
C1117	H17	C4110	F8	C4882	G15	C6365	E22	L4103	E8	R2003	C3	R6323	F23	X7721	A1	J4100	E9	J9220	G13
C1118	H17	C4113	E9	C4883	G15	C6366	E22	L5200	F17	R2004	C3	R6324	F22	X7722	C1	J4101	E8	J9221	G13
C1119	G17	C4114	F9	C4886	F15	C6367	E23	L6310	E23	R2100	E8	R6325	E23	Z	J4102	E8	J9222	G13	
C1120	H17	C4115	F9	C4890	F14	C6369	E22	L6311	E22	R2101	E8	R6617	G21	Z3300	E4	J4400	G17	J9224	G14
C1421	G15	C4116	E8	C4891	F15	C6370	F21	L7545	G3	R2102	E8	R6618	E20	Z3301	D4	J5200	F17	J9225	G12
C2001	B3	C4117	F8	C4892	F15	C7543	G3	L7546	F4	R2104	E8	R7703	G23	Z4204	B3	J5201	F17		
C2003	B3	C4118	E8	C4894	F15	C7550	F4	L7547	F4	R2105	E8	R7704	A2	Z5200	F17	J5202	F17		
C2005	C3	C4119	E9	C5200	F17	C7551	G3	L7548	G3	R2108	E8	R7706	G23	Z6302	F23	J5203	E17		
C2101	E8	C4801	G15	C5201	F17	C7552	F3	L7550	G3	R2134	F8	R9292	G14	Z6303	E24	J5204	E17		
C2102	E8	C4802	G15	C6302	F22	C7553	F3	L7700	G23	R2136	F8	R9293	F16	Z7700	H23	J6600	E20		
C2175	F8	C4821	G14	C6303	E22	C7554	F3	L7702	G22	R2139	F8	V	TST points	J6601	E20				
C2185	F8	C4822	E14	C6305	F22	C7555	F4	L7703	A2	R2147	F8	V3300	D4	J1101	G17	J6602	E20		
C2186	F8	C4824	G15	C6335	F22	C7701	G23	N	R2148	F8	X	J1102	G17	J6603	G20				
C2188	E9	C4851	G16	C6345	F22	C7702	G23	N1101	G17	R2707	G7	X2001	B4	J2000	B3	J7700	G23		
C2189	E9	C4854	F16	C6346	F22	C7703	G23	N2700	G9	R2708	G8	X2700	F10	J2001	C3	J9208	G13		
C2700	G9	C4855	G14	C6359	F23	C7704	A2	N4100	F8	R2709	G8	X5200	F19	J2002	C3	J9210	G17		
C3300	D3	C4865	G15	C6360	E23	L	N6302	E22	R2710	G8	X6300	E23	J3200	F17	J9211	G17			
C4104	E9	C4866	F15	C6361	F22	L2119	E22	N7541	F3	R4101	E9	X6301	E24	J3300	D3	J9214	F17		

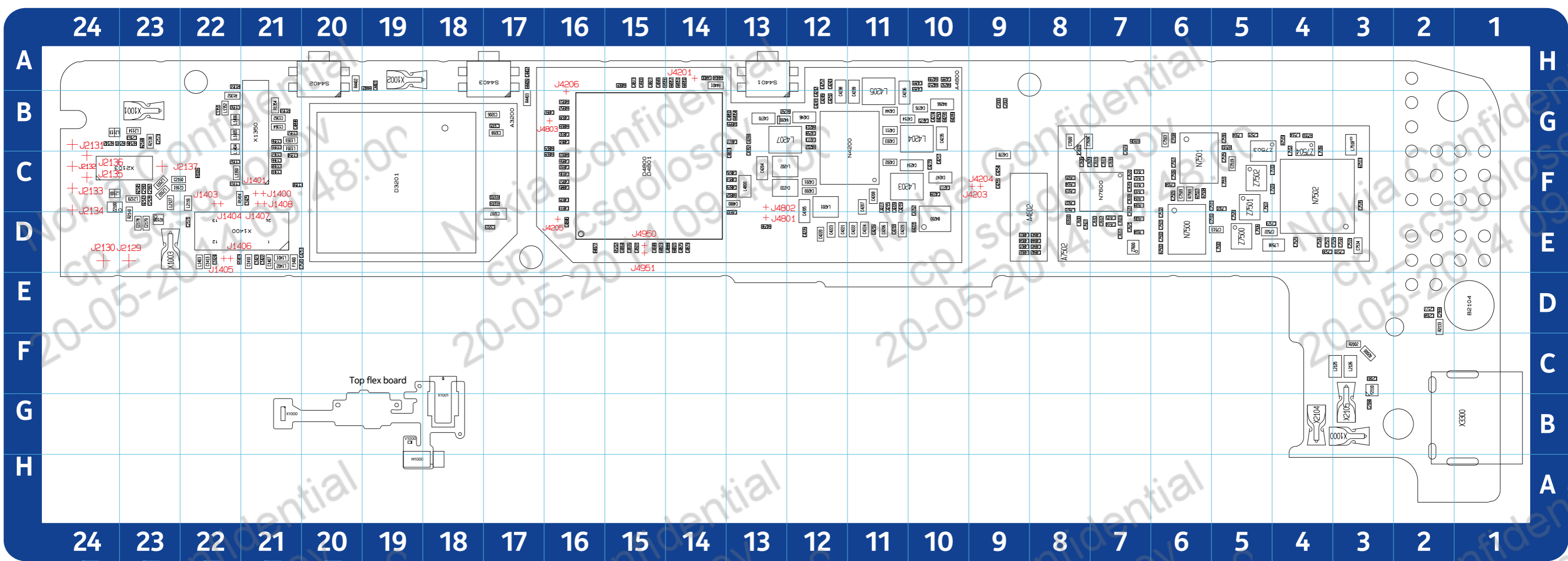

B	C1413	E22	C2187	F23	C4218	E11	C4246	G12	C4284	G13	C4848	E15	C7501	E6	C7527	E4	C7612	E7	L1352	G22	L4204	G10	L7600	E8	R1353	G21	R4251	H10	R4828	F16	S	Z4200	E12	J2131	G24		
B2104	D1	C1422	E21	C3203	E17	C4219	F11	C4247	F10	C4285	H10	C4849	H15	C7502	E6	C7528	E4	C7613	F7	L1353	G21	L4205	G11	L7601	G8	R1354	G21	R4266	G10	R4829	G16	S4401	H13	Z4201	F12	J2132	F24
B4200	E10	C1423	E21	C3205	G17	C4220	E12	C4249	G12	C4400	H14	C4850	G13	C7503	G6	C7529	E3	C7614	E7	L1401	E21	L4207	G13	L7603	E7	R1403	E22	R4289	G10	R4950	H14	S4402	H20	Z4202	F11	J2133	F24
C	C1424	E22	C3206	G17	C4221	E12	C4250	G12	C4401	H19	C4853	F13	C7504	F6	C7531	E3	C7615	E7	L1402	E21	L4800	F13	L7604	E7	R1404	F22	R4291	G10	R4951	H14	S4403	H17	Z4203	G10	J2134	F24	
C1350	G22	C1425	F21	C3207	E17	C4222	E11	C4252	F10	C4402	H17	C4856	F16	C7505	F6	C7532	E3	C7616	F7	L1403	E22	L4801	E9	L7606	E7	R2000	C3	R4292	H10	R4952	G16	V	Z7500	E5	J2135	F24	
C1351	G22	C2000	G9	C3208	G17	C4223	E12	C4253	E21	C4810	F16	C4857	F16	C7506	F6	C7533	E3	C7617	E7	L1404	G22	L4802	E9	L7608	F7	R2002	C3	R4297	G13	R4953	G16	V2108	E23	Z7501	F5	J2136	F24
C1352	F22	C2002	G9	C4200	F12	C4224	E11	C4254	F9	C4823	F13	C4861	G16	C7507	F6	C7534	E3	C7618	F7	L1405	G22	L4803	E9	L7609	F7	R2133	D2	R4298	E13	R4954	G13	V2110	C3	Z7502	F5	J2137	F23
C1353	F22	C2128	F23	C4201	F12	C4226	E12	C4255	F9	C4826	E15	C4864	E15	C7508	G6	C7535	F3	C7619	F7	L1406	G22	L4804	E9	L7610	F7	R2138	G23	R4299	H10	R4955	G13	V4200	G13	Z7503	G5	J4201	H14
C1354	F21	C2160	F23	C4202	F11	C4227	F11	C4257	H12	C4827	H15	C4873	H15	C7509	F6	C7549	E21	C7620	F7	L2100	F24	L7500	E5	L7611	F7	R2140	E23	R4401	H14	R4956	H15	X	Z7504	G4	J4203	F9	
C1355	G21	C2161	F23	C4203	G11	C4228	F10	C4258	G12	C4828	G16	C4875	E14	C7510	E6	C7600	G8	C7621	E7	L2102	F23	L7501	F5	L7612	F7	R2141	G23	R4402	H20	R4957	H14	X1000	B3	Z7600	E7	J4204	F9
C1356	G21	C2163	G23	C4204	F13	C4229	E11	C4270	G13	C4829	F13	C4876	F13	C7511	F6	C7601	F8	C7622	F7	L2103	F23	L7504	G5	L7613	F7	R2142	G24	R4403	G17	R5202	E15	X1001	G23	TST points	J4205	E16	
C1357	G21	C2168	D2	C4205	F12	C4233	F13	C4273	G12	C4830	E13	C4877	G13	C7513	E5	C7602	F8	C7623	G7	L2113	G24	L7506	E5	N	R2143	F23	R4404	H14	R7500	E6	X1002	H19	J1400	F21	J4206	G16	
C1358	F21	C2169	D2	C4206	E11	C4234	F10	C4274	G10	C4832	G16	C4879	E14	C7515	F5	C7603	F8	D	L2114	G23	L7507	F5	N4200	G11	R2144	G23	R4405	H19	R7507	F6	X1003	E23	J1401	F21	J4801	E13	
C1362	G21	C2171	E22	C4207	F11	C4235	G10	C4275	G10	C4833	F16	C4880	F13	C7516	G5	C7604	F8	D3201	F19	L2116	F22	L7508	E4	N7500	E6	R2145	F23	R4406	H17	R7508	F6	X1350	G21	J1403	F22	J4802	F13
C1364	G21	C2173	G23	C4208	F11	C4236	G11	C4276	G10	C4835	F16	C4885	F16	C7519	F5	C7605	F8	D4800	F15	L2125	C3	L7509	F4	N7501	F6	R2146	G23	R4801	E14	R7510	G5	X1400	E21	J1404	F22	J4803	G16
C1366	F21	C2177	D2	C4209	F11	C4238	G12	C4277	F10	C4836	F16	C4888	E14	C7520	E5	C7606	F8	D4801	F15	L2126	C3	L7510	F4	N7502	F4	R3200	F17	R4802	F13	R7513	F3	X2103	F23	J1405	E22	J4950	E15
C1367	F21	C2178	E23	C4211	G11	C4239	G11	C4278	F9	C4841	E8	C4897	G16	C7521	G5	C7607	E8	F	L2127	F23	L7512	G4	N7600	F7	R3209	F17	R4803	F16	R7519	G4	X2104	B4	J1406	E22	J4951	E15	
C1368	F21	C2179	E23	C4214	G11	C4241	G12	C4279	F10	C4842	E8	C4898	G21	C7522	E5	C7608	G8	F1400	E21	L2129	F23	L7514	G4	R	R4201	E10	R4805	H15	R7550	G4	X2105	B3	J1407	F21			
C1369	F21	C2180	F23	C4215	F11	C4242	G12	C4281	H10	C4843	E8	C4900	H15	C7523	E5	C7609	F8	L	L4201	F12	L7516	G4	R1006	F22	R4202	G12	R4809	G16	R7569	F6	X3300	B1	J1408	F21			
C1407	E21	C2183	C3	C4216	E11	C4243	H12	C4282	G13	C4844	E8	C4901	E15	C7525	E4	C7610	E7	L1350	F22	L4202	F13	L7518	G3	R1351	H22	R4203	G12	R4823	E15	R7600	E8	Z	J2129	E23			
C1410	E21	C2184	B3	C4217	F10	C4244	G11	C4283	H10	C4846	E16	C7500	E6	C7526	E4	C7611	F7	L1351	G21	L4203	F11	L7551	F5	R1352	G22	R4250	G10	R4827	E16	R7606	G7	Z2100	F24	J2130	E24		



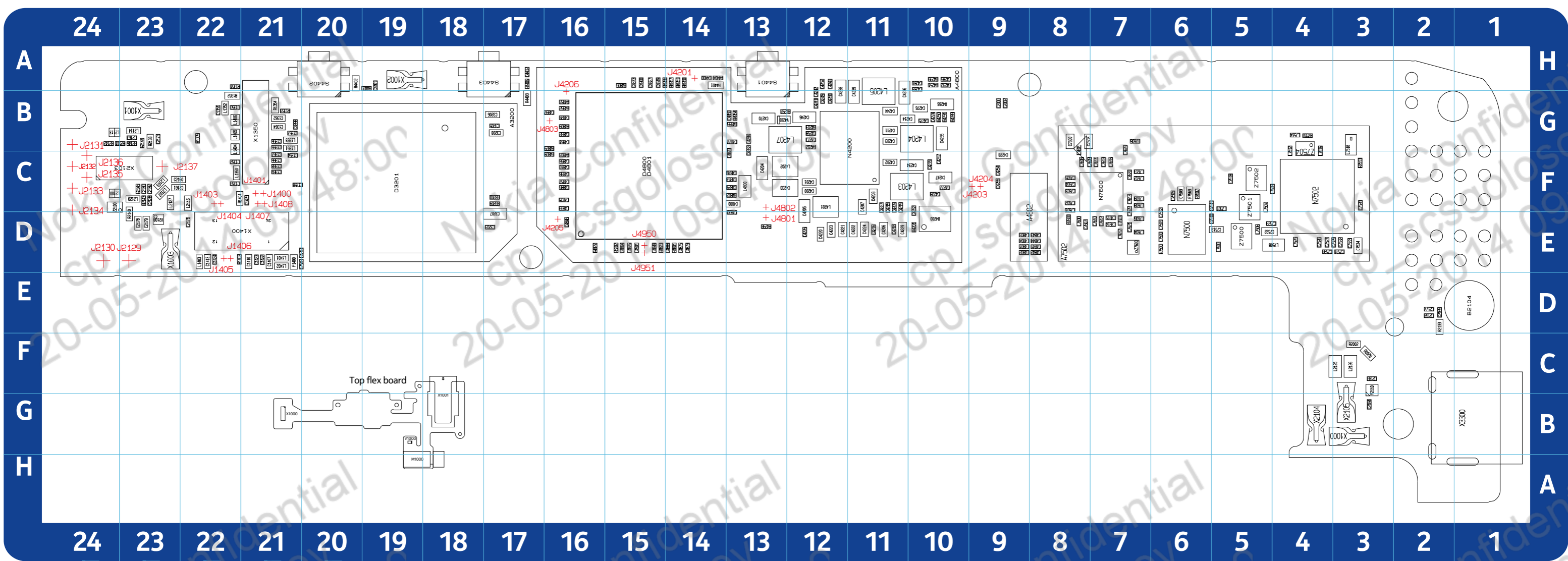

B	C1413	E22	C2187	F23	C4218	E11	C4246	G12	C4284	G13	C4848	E15	C7501	E6	C7600	G8	C7622	F7	L2103	F23	L7506	E5	N7600	F7	R3209	F17	R4803	F16	R7600	E8	Z	J2130	E24		
B2104	D1	C1422	E21	C3203	E17	C4219	F11	C4247	F10	C4285	H10	C4849	H15	C7502	E6	C7601	F8	C7623	G7	L2113	G24	L7507	F5	R	R4201	E10	R4805	H15	R7606	G7	Z2100	F24	J2131	G24	
B4200	E10	C1423	E21	C3205	G17	C4220	E12	C4249	G12	C4400	H14	C4850	G13	C7505	F6	C7602	F8	D	L2114	G23	L7508	E4	R1009	G22	R4202	G12	R4809	G16	S	Z4200	E12	J2132	F24		
C	C1424	E22	C3206	G17	C4221	E12	C4250	G12	C4401	H19	C4853	F13	C7509	F6	C7603	F8	D3201	F19	L2116	F22	L7509	F4	R1351	H22	R4203	G12	R4823	E15	S4401	H13	Z4201	F12	J2133	F24	
C1350	G22	C1425	F21	C3207	E17	C4222	E11	C4252	F10	C4402	H17	C4856	F16	C7510	E6	C7604	F8	D4800	F15	L2125	C3	L7512	G4	R1352	G22	R4250	G10	R4827	E16	S4402	H20	Z4202	F11	J2134	F24
C1351	G22	C2000	G9	C3208	G17	C4223	E12	C4253	E21	C4810	F16	C4857	F16	C7511	F6	C7605	F8	D4801	F15	L2126	C3	L7514	G4	R1353	G21	R4251	H10	R4828	F16	S4403	H17	Z4203	G10	J2135	F24
C1352	F22	C2002	G9	C4200	F12	C4224	E11	C4254	F9	C4823	F13	C4861	G16	C7513	E5	C7606	F8	F	L2127	F23	L7516	G4	R1354	G21	R4266	G10	R4829	G16	V	Z7500	E5	J2136	F24		
C1353	F22	C2128	F23	C4201	F12	C4226	E12	C4255	F9	C4826	E15	C4864	E15	C7518	F5	C7607	E8	F1400	E21	L2129	F23	L7518	G3	R1403	E22	R4289	G10	R4950	H14	V2108	E23	Z7501	F5	J2137	F23
C1354	F21	C2160	F23	C4202	F11	C4227	F11	C4257	H12	C4827	H15	C4873	H15	C7522	E5	C7608	G8	L	L4201	F12	L7600	E8	R1404	F22	R4291	G10	R4951	H14	V2110	C3	Z7502	F5	J4201	H14	
C1355	G21	C2161	F23	C4203	G11	C4228	F10	C4258	G12	C4828	G16	C4875	E14	C7523	E5	C7609	F8	L1350	F22	L4202	F13	L7601	G8	R2000	C3	R4292	H10	R4952	G16	V4200	G13	Z7504	G4	J4203	F9
C1356	G21	C2163	G23	C4204	F13	C4229	E11	C4270	G13	C4829	F13	C4876	F13	C7525	E4	C7610	E7	L1351	G21	L4203	F11	L7603	E7	R2002	C3	R4297	G13	R4953	G16	X	Z7600	E7	J4204	F9	
C1357	G21	C2168	D2	C4205	F12	C4233	F13	C4273	G12	C4830	E13	C4877	G13	C7526	E4	C7611	F7	L1352	G22	L4204	G10	L7604	E7	R2133	D2	R4298	E13	R4954	G13	X1000	B3	TST points	J4205	E16	
C1358	F21	C2169	D2	C4206	E11	C4234	F10	C4274	G10	C4832	G16	C4879	E14	C7527	E4	C7612	E7	L1353	G21	L4205	G11	L7606	E7	R2138	G23	R4299	H10	R4955	G13	X1001	G23	J1400	F21	J4206	G16
C1362	G21	C2171	E22	C4207	F11	C4235	G10	C4275	G10	C4833	F16	C4880	F13	C7528	E4	C7613	F7	L1401	E21	L4207	G13	L7608	F7	R2140	E23	R4401	H14	R4956	H15	X1002	H19	J1401	F21	J4801	E13
C1364	G21	C2173	G23	C4208	F11	C4236	G11	C4276	G10	C4835	F16	C4885	F16	C7529	E3	C7614	E7	L1402	E21	L4800	F13	L7609	F7	R2141	G23	R4402	H20	R4957	H14	X1003	E23	J1403	F22	J4802	F13
C1366	F21	C2177	D2	C4209	F11	C4238	G12	C4277	F10	C4836	F16	C4888	E14	C7531	E3	C7615	E7	L1403	E22	L4801	E9	L7612	F7	R2142	G24	R4403	G17	R5202	E15	X1350	G21	J1404	F22	J4803	G16
C1367	F21	C2178	E23	C4211	G11	C4239	G11	C4278	F9	C4841	E8	C4897	G16	C7532	E3	C7616	F7	L1404	G22	L4802	E9	L7613	F7	R2143	F23	R4404	H14	R7500	E6	X1400	E21	J1405	E22	J4950	E15
C1368	F21	C2179	E23	C4214	G11	C4241	G12	C4279	F10	C4842	E8	C4898	G21	C7533	E3	C7617	E7	L1405	G22	L4803	E9	N	R2144	G23	R4405	H19	R7507	F6	X2103	F23	J1406	E22	J4951	E15	
C1369	F21	C2180	F23	C4215	F11	C4242	G12	C4281	H10	C4843	E8	C4900	H15	C7534	E3	C7618	F7	L1406	G22	L4804	E9	N4200	G11	R2145	F23	R4406	H17	R7513	F3	X2104	B4	J1407	F21		
C1407	E21	C2183	C3	C4216	E11	C4243	H12	C4282	G13	C4844	E8	C4901	E15	C7535	F3	C7620	F7	L2100	F24	L7500	E5	N7500	E6	R2146	G23	R4801	E14	R7550	G4	X2105	B3	J1408	F21		
C1410	E21	C2184	B3	C4217	F10	C4244	G11	C4283	H10	C4846	E16	C7500	E6	C7549	E21	C7621	E7	L2102	F23	L7501	F5	N7502	F4	R3200	F17	R4802	F13	R7569	F6	X3300	B1	J2129	E23		

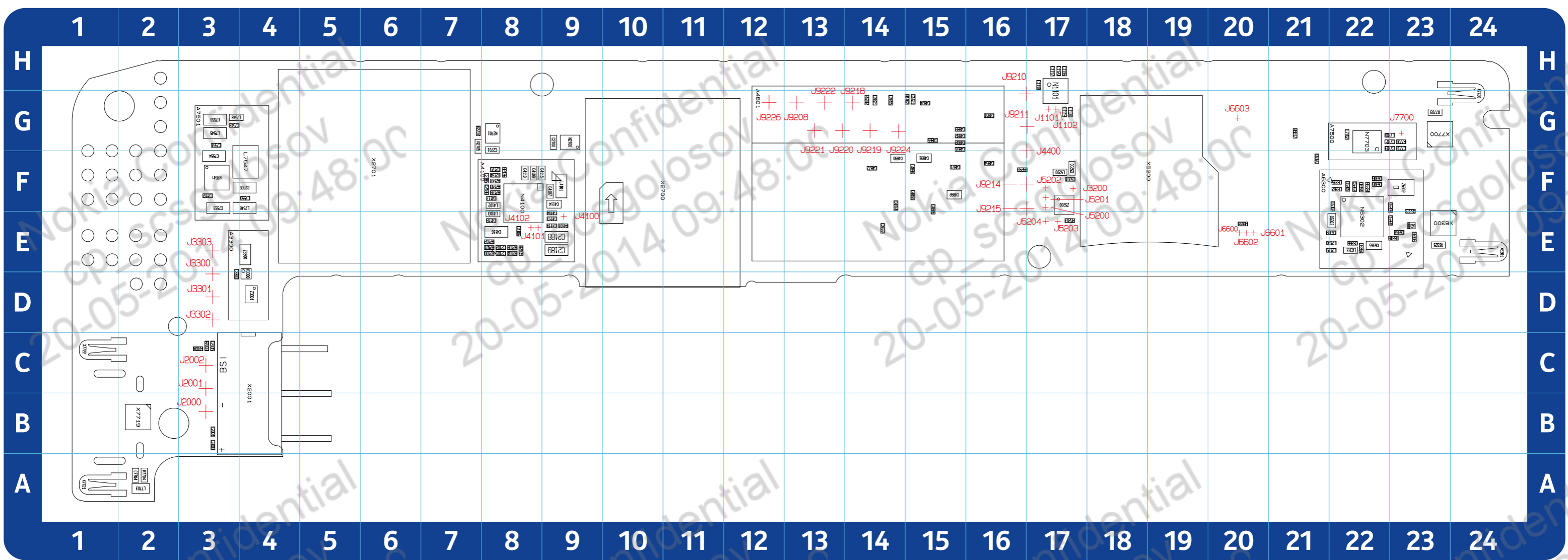

C	C4104	E9	C4866	F15	C6361	F22	L2119	E22	N6302	E22	R5203	E17	X6301	E24	J3300	D3	J9214	F17	
C1104	G17	C4106	E8	C4871	F15	C6362	F22	L2120	E22	N7541	F3	R6306	E23	X7700	G23	J3301	D3	J9215	F17
C1116	H17	C4107	F9	C4872	F14	C6363	F22	L4101	F9	N7703	G22	R6316	E23	X7719	B2	J3302	D3	J9218	G14
C1117	H17	C4108	F8	C4874	F14	C6364	E22	L4102	F8	R	R6323	F23	X7720	G24	J3303	E3	J9219	G14	
C1118	H17	C4110	F8	C4882	G15	C6365	E22	L4103	E8	R1402	G15	R6324	F22	X7721	A1	J4100	E9	J9220	G13
C1119	G17	C4113	E9	C4883	G15	C6366	E22	L5200	F17	R2003	C3	R6325	E23	X7722	C1	J4101	E8	J9221	G13
C1120	H17	C4114	F9	C4886	F15	C6367	E23	L6310	E23	R2004	C3	R6617	G21	Z	J4102	E8	J9222	G13	
C1421	G15	C4115	F9	C4890	F14	C6369	E22	L6311	E22	R2100	E8	R6618	E20	Z3300	E4	J4400	G17	J9224	G14
C2001	B3	C4116	E8	C4891	F15	C6370	F21	L7545	G3	R2101	E8	R7703	G23	Z3301	D4	J5200	F17	J9225	G12
C2003	B3	C4117	F8	C4892	F15	C7543	G3	L7546	F4	R2102	E8	R7704	A2	Z4204	B3	J5201	F17		
C2005	C3	C4118	E8	C4894	F15	C7550	F4	L7547	F4	R2104	E8	R7706	G23	Z5200	F17	J5202	F17		
C2101	E8	C4119	E9	C5200	F17	C7551	G3	L7548	G3	R2105	E8	R9292	G14	Z6302	F23	J5203	E17		
C2102	E8	C4801	G15	C5201	F17	C7552	F3	L7550	G3	R2108	E8	R9293	F16	Z6303	E24	J5204	E17		
C2175	F8	C4802	G15	C6302	F22	C7553	F3	L7700	G23	R2134	F8	V	Z7700	H23	J6600	E20			
C2185	F8	C4821	G14	C6303	E22	C7554	F3	L7702	G22	R2136	F8	V3300	D4	TST points	J6601	E20			
C2186	F8	C4822	E14	C6305	F22	C7555	F4	L7703	A2	R2139	F8	X	J1101	G17	J6602	E20			
C2188	E9	C4824	G15	C6335	F22	C7701	G23	N	R2147	F8	X2001	B4	J1102	G17	J6603	G20			
C2189	E9	C4851	G16	C6345	F22	C7702	G23	N1101	G17	R2148	F8	X2700	F10	J2000	B3	J7700	G23		
C2700	G9	C4854	F16	C6346	F22	C7703	G23	N2700	G9	R2705	G7	X2701	F6	J2001	C3	J9208	G13		
C2701	G8	C4855	G14	C6359	F23	C7704	A2	N2701	G8	R2707	G7	X5200	F19	J2002	C3	J9210	G17		
C3300	D3	C4865	G15	C6360	E23	L	N4100	F8	R4101	E9	X6300	E23	J3200	F17	J9211	G17			



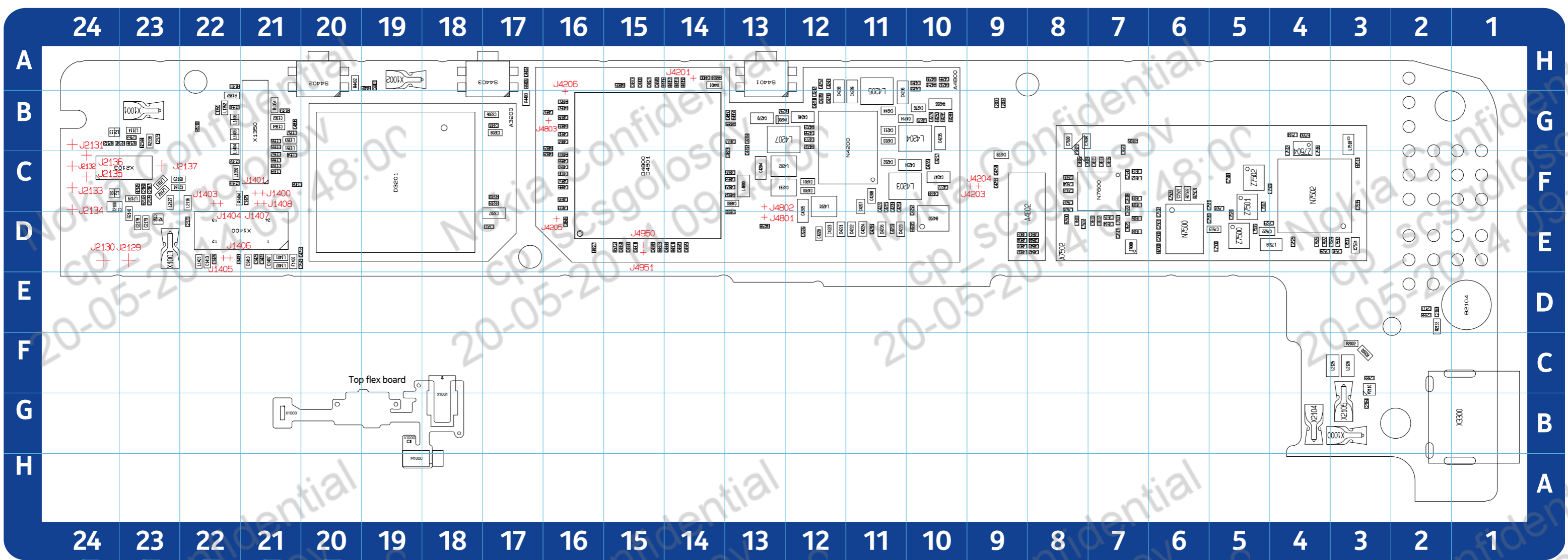

	24	23	22	21	20	19	18	17	16	15	14	13	12	11	10	9	8	7	6	5	4	3	2	1											
B	C1413	E22	C2187	F23	C4218	E11	C4246	G12	C4284	G13	C4848	E15	C7501	E6	C7549	E21	C7621	E7	L2102	F23	L7501	F5	N7502	F4	R3200	F17	R4802	F13	R7569	F6	X3300	B1	J2129	E23	
B2104	D1	C1422	E21	C3203	E17	C4219	F11	C4247	F10	C4285	H10	C4849	H15	C7502	E6	C7600	G8	C7622	F7	L2103	F23	L7506	E5	N7600	F7	R3209	F17	R4803	F16	R7600	E8	Z	J2130	E24	
B4200	E10	C1423	E21	C3205	G17	C4220	E12	C4249	G12	C4400	H14	C4850	G13	C7505	F6	C7601	F8	C7623	G7	L2113	G24	L7507	F5	R	R4201	E10	R4805	H15	R7606	G7	Z2100	F24	J2131	G24	
C	C1424	E22	C3206	G17	C4221	E12	C4250	G12	C4401	H19	C4853	F13	C7509	F6	C7602	F8	D	L2114	G23	L7508	E4	R1010	G22	R4202	G12	R4809	G16	S	Z4200	E12	J2132	F24			
C1350	G22	C1425	F21	C3207	E17	C4222	E11	C4252	F10	C4402	H17	C4856	F16	C7510	E6	C7603	F8	D3201	F19	L2116	F22	L7509	F4	R1351	H22	R4203	G12	R4823	E15	S4401	H13	Z4201	F12	J2133	F24
C1351	G22	C2000	G9	C3208	G17	C4223	E12	C4253	E21	C4810	F16	C4857	F16	C7511	F6	C7604	F8	D4800	F15	L2125	C3	L7512	G4	R1352	G22	R4250	G10	R4827	E16	S4402	H20	Z4202	F11	J2134	F24
C1352	F22	C2002	G9	C4200	F12	C4224	E11	C4254	F9	C4823	F13	C4861	G16	C7513	E5	C7605	F8	D4801	F15	L2126	C3	L7514	G4	R1353	G21	R4251	H10	R4828	F16	S4403	H17	Z4203	G10	J2135	F24
C1353	F22	C2128	F23	C4201	F12	C4226	E12	C4255	F9	C4826	E15	C4864	E15	C7518	F5	C7606	F8	F	L2127	F23	L7516	G4	R1354	G21	R4266	G10	R4829	G16	V	Z7500	E5	J2136	F24		
C1354	F21	C2160	F23	C4202	F11	C4227	F11	C4257	H12	C4827	H15	C4873	H15	C7520	E5	C7607	E8	F1400	E21	L2129	F23	L7518	G3	R1403	E22	R4289	G10	R4950	H14	V2108	E23	Z7501	F5	J2137	F23
C1355	G21	C2161	F23	C4203	G11	C4228	F10	C4258	G12	C4828	G16	C4875	E14	C7522	E5	C7608	G8	L	L4201	F12	L7600	E8	R1404	F22	R4291	G10	R4951	H14	V2110	C3	Z7502	F5	J4201	H14	
C1356	G21	C2163	G23	C4204	F13	C4229	E11	C4270	G13	C4829	F13	C4876	F13	C7523	E5	C7609	F8	L1350	F22	L4202	F13	L7601	G8	R2000	C3	R4292	H10	R4952	G16	V4200	G13	Z7504	G4	J4203	F9
C1357	G21	C2168	D2	C4205	F12	C4233	F13	C4273	G12	C4830	E13	C4877	G13	C7525	E4	C7610	E7	L1351	G21	L4203	F11	L7603	E7	R2002	C3	R4297	G13	R4953	G16	X	Z7600	E7	J4204	F9	
C1358	F21	C2169	D2	C4206	E11	C4234	F10	C4274	G10	C4832	G16	C4879	E14	C7526	E4	C7611	F7	L1352	G22	L4204	G10	L7604	E7	R2133	D2	R4298	E13	R4954	G13	X1000	B3	TST points	J4205	E16	
C1362	G21	C2171	E22	C4207	F11	C4235	G10	C4275	G10	C4833	F16	C4880	F13	C7527	E4	C7612	E7	L1353	G21	L4205	G11	L7606	E7	R2138	G23	R4299	H10	R4955	G13	X1001	G23	J1400	F21	J4206	G16
C1364	G21	C2173	G23	C4208	F11	C4236	G11	C4276	G10	C4835	F16	C4885	F16	C7528	E4	C7613	F7	L1401	E21	L4207	G13	L7608	F7	R2140	E23	R4401	H14	R4956	H15	X1002	H19	J1401	F21	J4801	E13
C1366	F21	C2177	D2	C4209	F11	C4238	G12	C4277	F10	C4836	F16	C4888	E14	C7529	E3	C7614	E7	L1402	E21	L4800	F13	L7609	F7	R2141	G23	R4402	H20	R4957	H14	X1003	E23	J1403	F22	J4802	F13
C1367	F21	C2178	E23	C4211	G11	C4239	G11	C4278	F9	C4841	E8	C4897	G16	C7531	E3	C7615	E7	L1403	E22	L4801	E9	L7612	F7	R2142	G24	R4403	G17	R5202	E15	X1350	G21	J1404	F22	J4803	G16
C1368	F21	C2179	E23	C4214	G11	C4241	G12	C4279	F10	C4842	E8	C4898	G21	C7532	E3	C7616	F7	L1404	G22	L4802	E9	L7613	F7	R2143	F23	R4404	H14	R7500	E6	X1400	E21	J1405	E22	J4950	E15
C1369	F21	C2180	F23	C4215	F11	C4242	G12	C4281	H10	C4843	E8	C4900	H15	C7533	E3	C7617	E7	L1405	G22	L4803	E9	N	R2144	G23	R4405	H19	R7507	F6	X2103	F23	J1406	E22	J4951	E15	
C1407	E21	C2183	C3	C4216	E11	C4243	H12	C4282	G13	C4844	E8	C4901	E15	C7534	E3	C7618	F7	L1406	G22	L4804	E9	N4200	G11	R2145	F23	R4406	H17	R7513	F3	X2104	B4	J1407	F21		
C1410	E21	C2184	B3	C4217	F10	C4244	G11	C4283	H10	C4846	E16	C7500	E6	C7535	F3	C7620	F7	L2100	F24	L7500	E5	N7500	E6	R2146	G23	R4801	E14	R7550	G4	X2105	B3	J1408	F21		

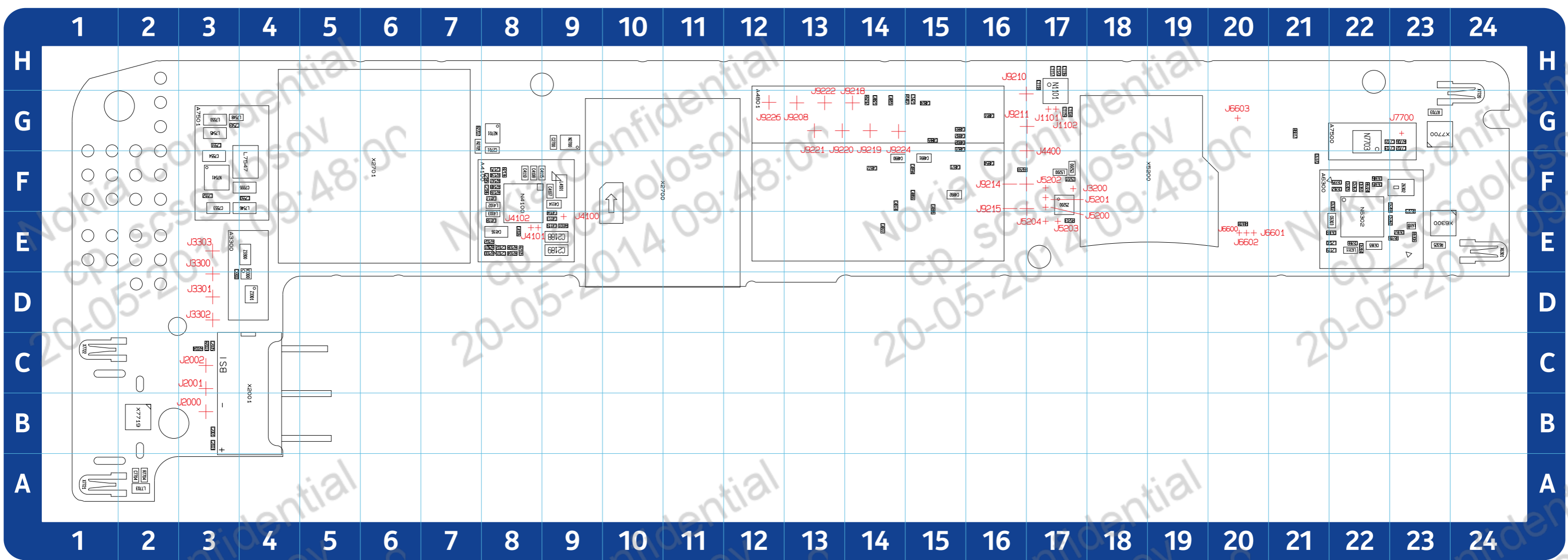

C	C4104	E9	C4866	F15	C6361	F22	L2119	E22	N7703	G22	R6316	E23	X7719	B2	J3302	D3	J9218	G14	
C1104	G17	C4106	E8	C4871	F15	C6362	F22	L2120	E22	R	R6323	F23	X7720	G24	J3303	E3	J9219	G14	
C1116	H17	C4107	F9	C4872	F14	C6363	F22	L4101	F9	R1402	G15	R6324	F22	X7721	A1	J4100	E9	J9220	G13
C1117	H17	C4108	F8	C4874	F14	C6364	E22	L4102	F8	R2003	C3	R6325	E23	X7722	C1	J4101	E8	J9221	G13
C1118	H17	C4110	F8	C4882	G15	C6365	E22	L4103	E8	R2004	C3	R6617	G21	Z	J4102	E8	J9222	G13	
C1119	G17	C4113	E9	C4883	G15	C6366	E22	L5200	F17	R2100	E8	R6618	E20	Z3300	E4	J4400	G17	J9224	G14
C1120	H17	C4114	F9	C4886	F15	C6367	E23	L6310	E23	R2101	E8	R7703	G23	Z3301	D4	J5200	F17	J9225	G12
C1421	G15	C4115	F9	C4890	F14	C6369	E22	L6311	E22	R2102	E8	R7704	A2	Z4204	B3	J5201	F17		
C2001	B3	C4116	E8	C4891	F15	C6370	F21	L7545	G3	R2104	E8	R7706	G23	Z5200	F17	J5202	F17		
C2003	B3	C4117	F8	C4892	F15	C7543	G3	L7546	F4	R2105	E8	R9292	G14	Z6302	F23	J5203	E17		
C2005	C3	C4118	E8	C4894	F15	C7550	F4	L7547	F4	R2108	E8	R9293	F16	Z6303	E24	J5204	E17		
C2101	E8	C4119	E9	C5200	F17	C7551	G3	L7548	G3	R2134	F8	V	Z7700	H23	J6600	E20			
C2102	E8	C4801	G15	C5201	F17	C7552	F3	L7550	G3	R2136	F8	V3300	D4	TST points	J6601	E20			
C2175	F8	C4802	G15	C6302	F22	C7553	F3	L7703	A2	R2139	F8	X	J1101	G17	J6602	E20			
C2185	F8	C4821	G14	C6303	E22	C7554	F3	N	R2147	F8	X2001	B4	J1102	G17	J6603	G20			
C2186	F8	C4822	E14	C6305	F22	C7555	F4	N1101	G17	R2148	F8	X2700	F10	J2000	B3	J7700	G23		
C2188	E9	C4824	G15	C6335	F22	C7701	G23	N2700	G9	R2705	G7	X2701	F6	J2001	C3	J9208	G13		
C2189	E9	C4851	G16	C6345	F22	C7702	G23	N2701	G8	R2707	G7	X5200	F19	J2002	C3	J9210	G17		
C2700	G9	C4854	F16	C6346	F22	C7703	G23	N4100	F8	R4101	E9	X6300	E23	J3200	F17	J9211	G17		
C2701	G8	C4855	G14	C6359	F23	C7704	A2	N6302	E22	R5203	E17	X6301	E24	J3300	D3	J9214	F17		
C3300	D3	C4865	G15	C6360	E23	L	N7541	F3	R6306	E23	X7700	G23	J3301	D3	J9215	F17			