

SAMSUNG

GSM TELEPHONE

SGH-D520

SERVICE *Manual*

GSM TELEPHONE



CONTENTS

1. Safety Precautions
2. Specification
3. Product Function
4. Array course control
5. Exploded View and Parts list
6. MAIN Electrical Parts List
7. Block Diagrams
8. PCB Diagrams
9. Flow Chart of Troubleshooting
10. Reference data
11. Exploded and assembling View

**SAMSUNG
ELECTRONICS**



목 차

1. Safety Precautions

- 1-1. Repair Precaution1-1
- 1-2. ESD(Electrostatically Sensitive Devices) Precaution1-2

2. Specification

- 2-1. GSM General Specification2-1
- 2-2. GSM TX power Level2-2

3. Product Function

4. Array course control

- 4-1. Downloading Binary Files4-2
- 4-2. Pre-requisite for Downloading4-2
- 4-3. S/W Downloader Program4-3

5. Exploded View and Parts list

- 5-1. Cellular phone Exploded View5-1
- 5-2. Cellular phone Parts list5-2

6. MAIN Electrical Parts List

7. Block Diagrams

8. PCB Diagrams

9. Flow Chart of Troubleshooting

- 9-1. Baseband9-1
 - 9-1-1. Power ON9-1
 - 9-1-2. Initial9-4
 - 9-1-3. SIM Part9-6
 - 9-1-4. Microphone Part9-7
 - 9-1-5. Speaker Part_1(MP3, SPEAKER PHONE)9-8
 - 9-1-6. Speaker Part_2(RECEIVER)9-10
 - 9-1-7. Charging Part9-11
-

목 차

9-2. RF	9-13
9-2-1. EGSM RX	9-13
9-2-2. DCS RX	9-15
9-2-3. PCS RX	9-16
9-2-4. EGSM TX	9-17
9-2-5. DCS TX	9-18
9-2-6. PCS TX	9-19

10. Reference data

11. Exploded and assembling View

11-1. Cellular phone Exploded View	11-1
11-2. Cellular phone assembling	11-2
11-3. Slide FPCB KIT assembling	11-29

1. Safety Precautions

1-1. Repair Precaution

- Repair in Shield Box, during detailed tuning.
Take specially care of tuning or test,
because specipicty of cellular phone is sensitive for surrounding interference(RF noise).
- Be careful to use a kind of magnetic object or tool,
because performance of parts is damaged by the influence of manetic force.
- Surely use a standard screwdriver when you disassemble this product,
otherwise screw will be worn away.
- Use a thicken twisted wire when you measure level.
A thicken twisted wire has low resistance, therefore error of measurement is few.
- Repair after separate Test Pack and Set because for short danger (for example an
overcurrent and furious flames of parts etc) when you repair board in condition of
connecting Test Pack and tuning on.
- Take specially care of soldering, because Land of PCB is small and weak in heat.
- Surely tune on/off while using AC power plug, because a repair of battery charger is
dangerous when tuning ON/OFF PBA and Connector after disassembling charger.
- Don't use as you pleases after change other material than replacement registered on SEC
System.
Otherwise engineer in charge isn't charged with problem that you don't keep this rules.

1-2. ESD(Electrostatically Sensitive Devices) Precaution

Several semiconductor may be damaged easily by static electricity. Such parts are called by ESD(Electrostatically Sensitive Devices), for example IC,BGA chip etc. Read Precaution below. You can prevent from ESD damage by static electricity.

- Remove static electricity remained your body before you touch semiconductor or parts with semiconductor. There are ways that you touch an earthed place or wear static electricity prevention string on wrist.
- Use earthed soldering steel when you connect or disconnect ESD.
- Use soldering removing tool to break static electricity. , otherwise ESD will be damaged by static electricity.
- Don't unpack until you set up ESD on product. Because most of ESD are packed by box and aluminum plate to have conductive power,they are prevented from static electricity.
- You must maintain electric contact between ESD and place due to be set up until ESD is connected completely to the proper place or a circuit board.

2. Specification

2-1. GSM General Specification

		E-GSM	DCS1800	PCS1900
Freq. Band[MHz] Uplink/Downlink		880~915 925~960	1710~1785 1805~1880	1850~1910 1930~1990
ARFCN range		975~1023 0~124	512~885	512~810
Tx/Rx spacing		45 MHz	95 MHz	80 MHz
Mod. Bit rate/ Bit Period	GPRS	270.833 Kbps 3.692 us	270.833 Kbps 3.692 us	270.833 Kbps 3.692 us
Time Slot Period/Frame Period		576.9 us 4.615 ms	576.9 us 4.615 ms	576.9 us 4.615 ms
Modulation	GPRS	0.3 GMSK	0.3 GMSK	0.3 GMSK
MS Power	GPRS	33 dBm~5 dBm	30 dBm~0 dBm	30 dBm~0 dBm
Power Level	GPRS	5~19(class4)	0~15(class1)	0~15(class1)
Sensitivity		-102 dBm	-100 dBm	-102 dBm
TDMA Mux		8	8	8
Cell Radius		35 Km	2 Km	2 Km
Operating Temperature		-20 ℃ ~ 45 ℃	-20 ℃ ~ 45 ℃	-20 ℃ ~ 45 ℃
Supply Voltage		3.7 V	3.7 V	3.7 V
Size and Weight		Dimention : 97(H) × 52(W) × 14.9(D) mm Weight : 96 g (with standard battery)		

2-2. GSM TX Power Level

TX Power control level	E-GSM	TX Power control level	DCS1800	TX Power control level	PCS1900
5	33±2 dBm	0	30±3 dBm	0	30±3 dBm
6	31±2 dBm	1	28±3 dBm	1	28±3 dBm
7	29±2 dBm	2	26±3 dBm	2	26±3 dBm
8	27±2 dBm	3	24±3 dBm	3	24±3 dBm
9	25±2 dBm	4	22±3 dBm	4	22±3 dBm
10	23±2 dBm	5	20±3 dBm	5	20±3 dBm
11	21±2 dBm	6	18±3 dBm	6	18±3 dBm
12	19±2 dBm	7	16±3 dBm	7	16±3 dBm
13	17±2 dBm	8	14±3 dBm	8	14±3 dBm
14	15±2 dBm	9	12±4 dBm	9	12±4 dBm
15	13±2 dBm	10	10±4 dBm	10	10±4 dBm
16	11±2 dBm	11	8±4 dBm	11	8±4 dBm
17	9±2d Bm	12	6±4 dBm	12	6±4 dBm
18	7±2d Bm	13	4±4 dBm	13	4±4 dBm
19	5±2d Bm	14	2±5 dBm	14	2±5 dBm
		15	0±5 dBm	15	0±5 dBm

3. Product Function

3-1. Main Function

- Camera and camcorder
- Image editor
- File viewer
- Bluetooth
- Get personal with photo caller ID
- Name card
- Multimedia Message Service (MMS)
- Email
- Web browser
- Java
- Voice recorder

4. Array course control



Test Jig (GH80-03307A)



Test Cable (GH39-00127A)



RF Test Cable (GH39-00283A)

Software Downloading

4-1. Downloading Binary Files

- Two binary files for downloading D520.
 - D520XXYY.s3 : Main source code binary.
 - D520XXYY.cts : Default Contents binary.

4-2. Pre-requisite for Downloading

- Downloader Program([OptiFlash.exe](#))
- D520 Mobile Phone
- Data Cable
- Binary files
- CTS files

4-3. S/W Downloader Program

1. Load the binary download program by executing the **"OptiFlash.exe"**

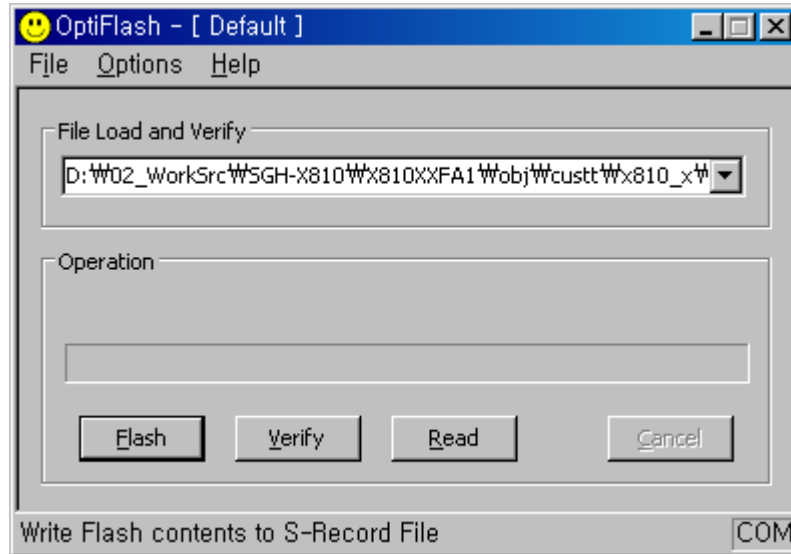

2. Select the **"Options" -> "Settings" -> "Generic" -> "Specify hardware platform"**.

Choose hardware platform for the downloader file setting.

Set the everything else as the default values which are shown below

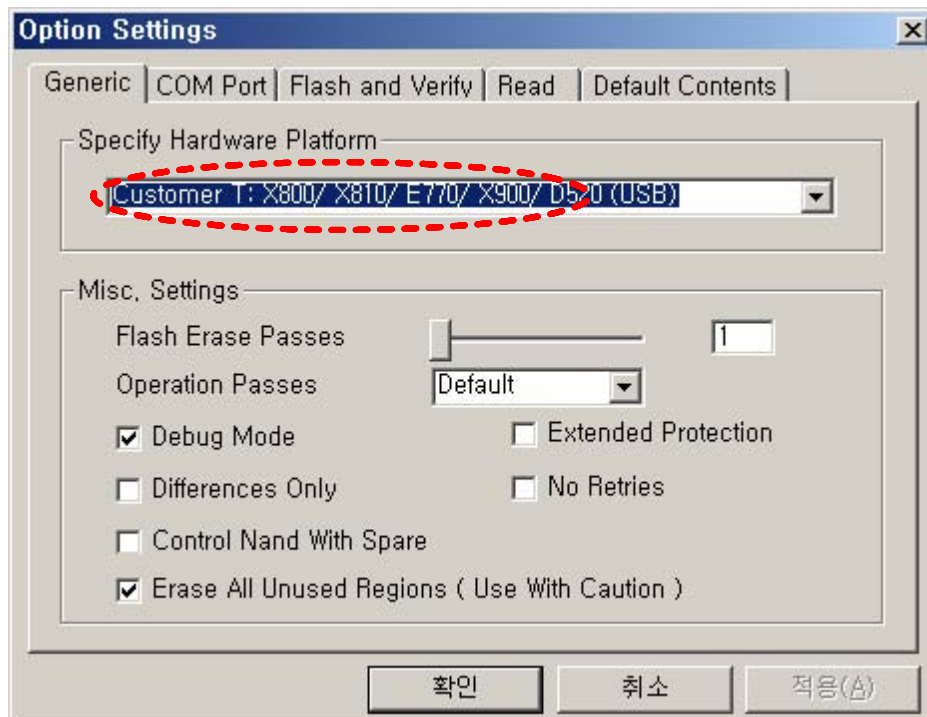

3. Select the **COM port** when the download cable is connected

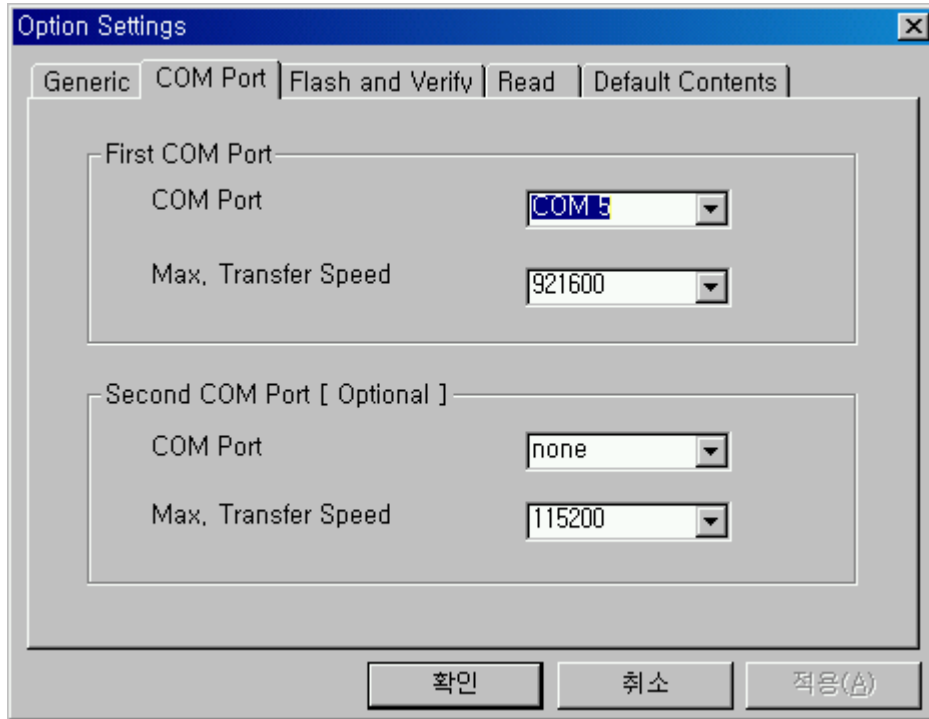

Up to 64 ports are supported. Additionally you can select the maximum transfer speed OptiFlash will use to communicate with the phone. However, OptiFlash will use a slower speed if either the PC's or the phone's serial hardware is incapable of handling the selected speed

4. Select the "**Flash&Verify**" -> "**Browse**"

Set the directory path and choose the latest s/w binary, for example "D520XXYY.s3", for the downloader binary setting.

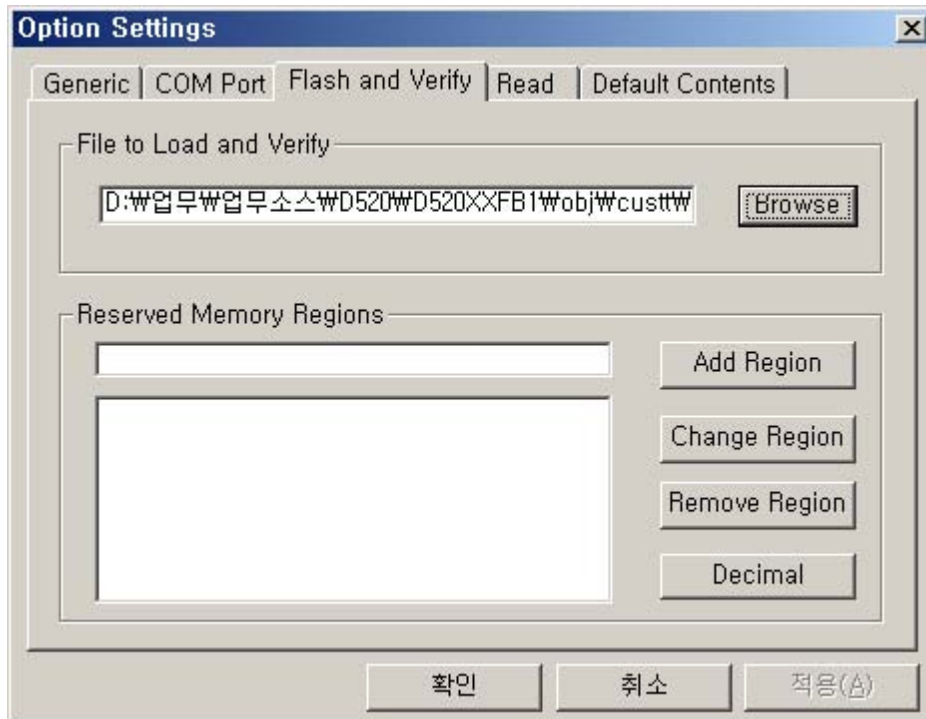

In case of D520 the reserved regions are not a necessity. (It is defined in platform.def file)

5. Select the "**Default Contents**" -> "**Browse**"

Set the directory path and choose the CTS file, for example "D520XXYY.cts", for the downloader binary setting.

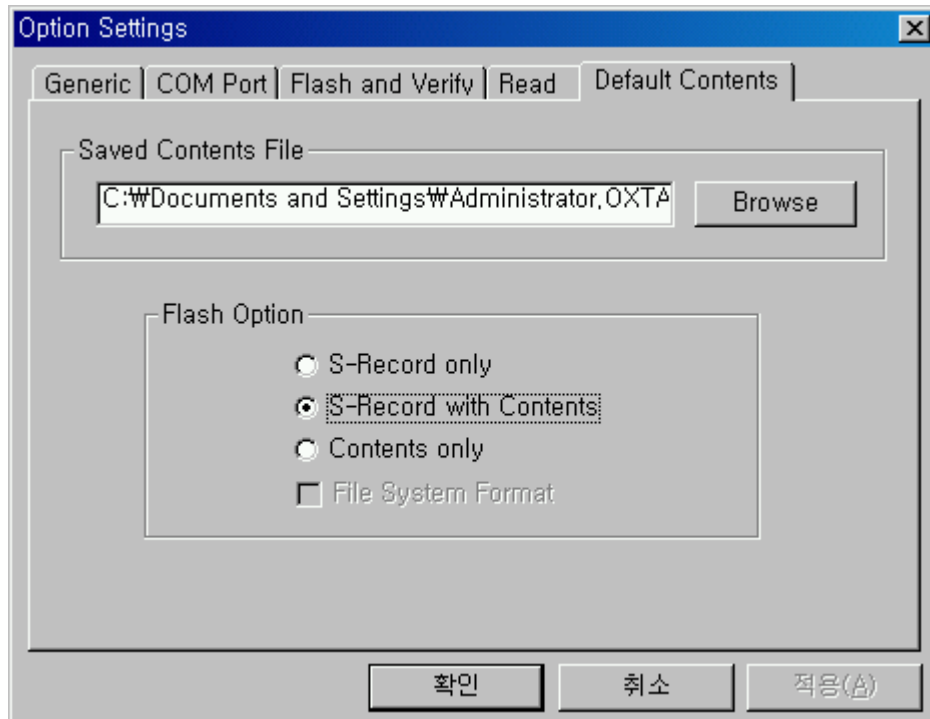

Function of Flash option

S-Record only : download binary only



S-Record with Contents : download binary with default contents

Contents only : download default contents

6. Click "**OK**" button then press "**Flash**".
 (Before pressing 'Flash' button, push the button '*****' and '**END**' at the same time. Then press 'Flash'.)

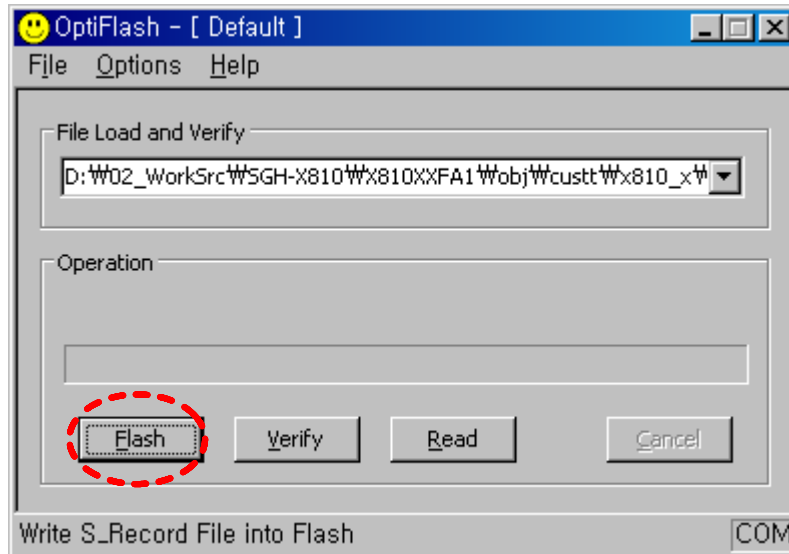
Downloader will upload the binary file as below for the downloading. 



7. When downloading is finished successfully, there is a "All is well" message. 
8. After finishing downloading, Certain memory resets should be done to guarantee the normal performance. 
9. Confirm the downloaded version name and etc. : 

***#5002*8376263#** 

Full Reset : 

***2767*3855#**

5. Exploded View and Parts List

5-1. Cellular phone Exploded View

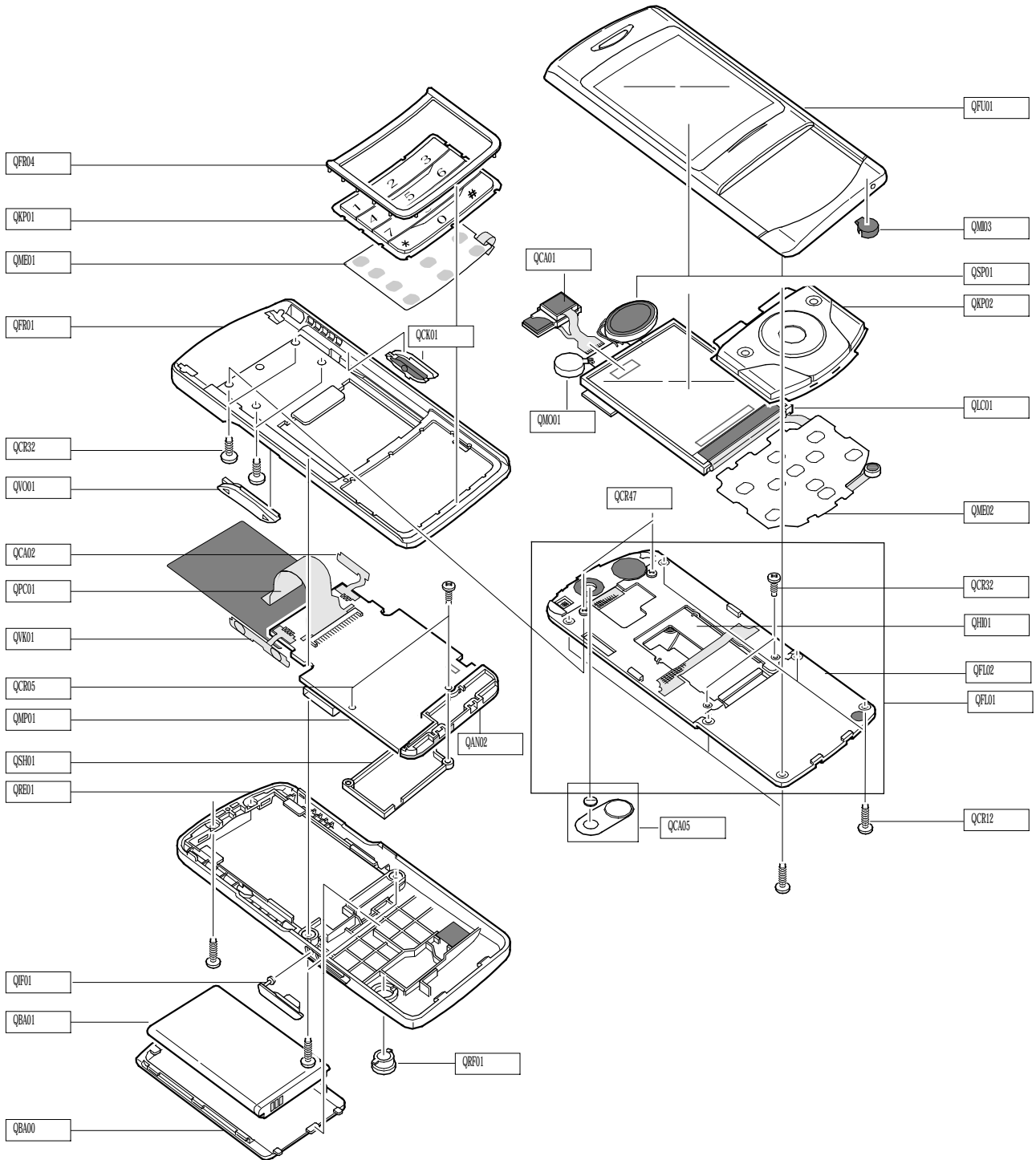

5-2. Cellular phone Parts list

Design LOC	Discription	SEC CODE	
QAN02	INTENNA-SGHD520	GH42-00740A	
QBA00	ASSY-COVER-BATT	GH98-00721B	
QBA01	INNER BATTERY PACK-800MAH,BLK,	GH43-01850A	
QCA01	UNIT-CAMERA	GH59-02860A	
QCA02	UNIT-CAMERA KEY	GH59-02799A	
QCA05	MEC-SUB FLASH DECO	GH75-08862A	
QCK01	MEC-CAM KEY	GH75-08866A	
QCR05	SCREW-MACHINE	6001-001478	
QCR05	SCREW-MACHINE	6001-001478	
QCR12	SCREW-MACHINE	6001-001530	
QCR32	SCREW-MACHINE	6001-001700	
QFR01	MEC-SUA FRONT COVER	GH75-08863B	
QFR04	PMO-FRONT COVER BUSH	GH72-27856A	
QKP01	MEC-KEYPAD MAIN	GH75-08864B	
QKP02	MEC-KEYPAD SUB	GH75-08861B	
QLC01	ELA UNIT-SGHD520 LCD	GH96-02099A	
QME01	UNIT-KEY PAD	GH59-02716A	
QME02	UNIT-NAVI KEY	GH59-02717A	
QMO01	MOTOR DC-SPHV8400	GH31-00187A	
QMP01	PBA MAIN-SGHD520	GH92-02481A	
QPC01	MEA-SLIDE FPCB KIT	GH97-05579A	
QRF01	PMO-COVER RF	GH72-29405B	
QSH01	NDC-SHIELD CAN	GH71-05961A	
QSP01	SPEAKER	3001-001906	
QVK01	UNIT-VOLUME KEY	GH59-02798A	
QVO01	MEC-KEY VOLUME	GH75-08277A	
QRE01	MEC-SUA REAR COVER	GH75-08865B	
	QIF01	PMO-IF COVER	GH72-27858B
QFL01	MEC-SUA SLIDE LOW HINGE	GH75-08859B	
	QCR32	SCREW-MACHINE	6001-001700
	QCR47	SCREW-MACHINE	6001-001695
	QFL02	MEC-SLIDE LOWER	GH75-08860B
	QHI01	MEC-HINGE	GH75-09414A
QFU01	MEC-SUA SLIDE UPPER	GH75-08857B	
	QMI03	RMO-MIC HOLDER	GH73-05704A

Discription	SEC CODE
BAG PE	6902-000297
CBF INTERFACE-DATA LINK CABLE	GH39-00444A
ADAPTOR-SGHD800 TA(EU)	GH44-01060A
S/W CD-SAMSUNGPCSTUDIO 3.0	GH46-00215A
EARPHONE-STEREO HEADSET	GH59-02499A
LABEL(P)-IMEI	GH68-01335D
LABEL(P)-WATER SOAK	GH68-02026A
LABEL(P)-WATER SOAK	GH68-02026A
MANUAL-SFC CARD	GH68-07937A
MANUAL USERS-EU FRENCH	GH68-09205A
LABEL(P)-MAIN (EU)	GH68-09251A
MANUAL USERS-EU DUTCH	GH68-09509A
CUSHION-CASE TA2 MA2	GH69-03632A
BOX(P)-UNIT MAIN (EU)	GH69-03635A
MPR-BOHO VINYL LCD CONN	GH74-15350A
MPR-TAPE REMOVE LCD	GH74-18286A
MPR-VINYL BOHO MAIN	GH74-19951A
MPR-TAPE GASKET MAIN FPC	GH74-21361A
MPR-TAPE NAVI CONN BTM	GH74-21362A
MPR-TAPE CAMERA CONN	GH74-21364A
MPR-TAPE LCD CONN C	GH74-21365A
MPR-TAPE NAVI KEY CONN	GH74-21366A
MPR-TAPE MAIN CONN C	GH74-21367A
MPR-TAPE MAIN CONN A	GH74-21368A
MPR-TAPE LCD CONN D	GH74-21369A
MPR-CUSHION NAVI KEY	GH74-21626A
MPR-CUSHION LCD BACK	GH74-21627A
MPR-VINYL BOHO SUB KEY	GH74-22225A

6. MAIN Electrical Parts List

SEC CODE	Design LOC	Discription	STATUS
4202-001095	ANT602	ANTENNA-CHIP	SA
4302-001201	BAT100	BATTERY-LI(2ND)	SA
3711-006025	BTC502	HEADER-BATTERY	SA
2203-006194	C100	C-CER,CHIP	SA
2203-006194	C101	C-CER,CHIP	SA
2203-006423	C102	C-CER,CHIP	SA
2203-006423	C103	C-CER,CHIP	SA
2203-006324	C104	C-CER,CHIP	SA
2203-006562	C105	C-CER,CHIP	SA
2203-006562	C106	C-CER,CHIP	SA
2203-006562	C107	C-CER,CHIP	SA
2203-006562	C108	C-CER,CHIP	SA
2203-006562	C109	C-CER,CHIP	SA
2203-006562	C110	C-CER,CHIP	SA
2203-006562	C111	C-CER,CHIP	SA
2203-005736	C112	C-CER,CHIP	SA
2203-006648	C113	C-CER,CHIP	SA
2203-006194	C114	C-CER,CHIP	SA
2203-001405	C115	C-CER,CHIP	SA
2203-006562	C116	C-CER,CHIP	SA
2203-006423	C117	C-CER,CHIP	SA
2203-006121	C118	C-CER,CHIP	SA
2203-006423	C119	C-CER,CHIP	SA
2203-005682	C120	C-CER,CHIP	SA
2203-005682	C121	C-CER,CHIP	SA
2203-005729	C122	C-CER,CHIP	SA
2203-006257	C124	C-CER,CHIP	SA
2203-006562	C125	C-CER,CHIP	SA
2203-006423	C126	C-CER,CHIP	SA
2203-006562	C128	C-CER,CHIP	SA
2203-006562	C129	C-CER,CHIP	SA
2203-006825	C130	C-CER,CHIP	SA
2203-006562	C131	C-CER,CHIP	SA
2203-006825	C132	C-CER,CHIP	SA
2203-006562	C135	C-CER,CHIP	SA
2203-006423	C136	C-CER,CHIP	SA
2203-006348	C137	C-CER,CHIP	SA
2203-006324	C138	C-CER,CHIP	SA
2203-006194	C200	C-CER,CHIP	SA
2203-006194	C201	C-CER,CHIP	SA
2203-006423	C202	C-CER,CHIP	SA
2203-006423	C203	C-CER,CHIP	SA

Main Electrical Parts List

SEC CODE	Design LOC	Discription	STATUS
2203-006423	C204	C-CER,CHIP	SA
2203-006194	C205	C-CER,CHIP	SA
2203-006423	C206	C-CER,CHIP	SA
2203-006194	C207	C-CER,CHIP	SA
2203-006423	C208	C-CER,CHIP	SA
2203-005727	C209	C-CER,CHIP	SA
2203-005727	C210	C-CER,CHIP	SA
2203-000254	C211	C-CER,CHIP	SA
2203-005806	C212	C-CER,CHIP	SA
2203-005806	C213	C-CER,CHIP	SA
2203-006423	C215	C-CER,CHIP	SA
2203-006194	C216	C-CER,CHIP	SA
2203-006194	C217	C-CER,CHIP	SA
2203-006423	C218	C-CER,CHIP	SA
2203-006562	C300	C-CER,CHIP	SA
2203-006562	C301	C-CER,CHIP	SA
2203-006423	C302	C-CER,CHIP	SA
2203-006562	C303	C-CER,CHIP	SA
2203-006423	C304	C-CER,CHIP	SA
2203-006305	C305	C-CER,CHIP	SA
2203-006305	C306	C-CER,CHIP	SA
2203-006562	C309	C-CER,CHIP	SA
2203-006423	C312	C-CER,CHIP	SA
2203-006324	C313	C-CER,CHIP	SA
2203-006423	C314	C-CER,CHIP	SA
2203-006379	C315	C-CER,CHIP	SA
2203-006423	C316	C-CER,CHIP	SA
2203-006562	C317	C-CER,CHIP	SA
2203-006648	C318	C-CER,CHIP	SA
2203-005806	C319	C-CER,CHIP	SA
2203-006423	C320	C-CER,CHIP	SA
2203-000654	C321	C-CER,CHIP	SA
2203-006423	C322	C-CER,CHIP	SA
2203-006423	C326	C-CER,CHIP	SA
2203-006423	C327	C-CER,CHIP	SA
2203-002709	C328	C-CER,CHIP	SA
2203-006423	C330	C-CER,CHIP	SA
2203-006423	C331	C-CER,CHIP	SA
2203-006668	C332	C-CER,CHIP	SA
2203-006423	C333	C-CER,CHIP	SA
2203-006423	C342	C-CER,CHIP	SA
2203-006562	C343	C-CER,CHIP	SA

SEC CODE	Design LOC	Discription	STATUS
2203-006562	C344	C-CER,CHIP	SA
2203-006260	C347	C-CER,CHIP	SA
2203-006260	C348	C-CER,CHIP	SA
2203-006348	C400	C-CER,CHIP	SA
2203-006423	C401	C-CER,CHIP	SA
2203-000854	C403	C-CER,CHIP	SA
2203-000854	C404	C-CER,CHIP	SA
2203-006562	C406	C-CER,CHIP	SA
2203-006423	C407	C-CER,CHIP	SA
2203-005682	C408	C-CER,CHIP	SA
2203-005682	C409	C-CER,CHIP	SA
2203-005682	C410	C-CER,CHIP	SA
2203-005682	C411	C-CER,CHIP	SA
2203-006257	C413	C-CER,CHIP	SA
2203-005682	C414	C-CER,CHIP	SA
2203-006626	C415	C-CER,CHIP	SA
2203-005682	C416	C-CER,CHIP	SA
2203-005683	C417	C-CER,CHIP	SA
2203-006348	C418	C-CER,CHIP	SA
2203-005682	C419	C-CER,CHIP	SA
2203-006626	C420	C-CER,CHIP	SA
2203-005682	C421	C-CER,CHIP	SA
2203-006348	C422	C-CER,CHIP	SA
2203-005682	C423	C-CER,CHIP	SA
2203-006260	C424	C-CER,CHIP	SA
2203-006260	C426	C-CER,CHIP	SA
2203-005682	C429	C-CER,CHIP	SA
2203-006825	C432	C-CER,CHIP	SA
2203-006825	C433	C-CER,CHIP	SA
2203-005736	C500	C-CER,CHIP	SA
2203-006048	C502	C-CER,CHIP	SA
2203-006562	C503	C-CER,CHIP	SA
2203-006257	C505	C-CER,CHIP	SA
2007-008055	C506	R-CHIP	SA
2203-005682	C507	C-CER,CHIP	SA
2203-006423	C508	C-CER,CHIP	SA
2203-006423	C509	C-CER,CHIP	SA
2203-006423	C510	C-CER,CHIP	SA
2203-006423	C511	C-CER,CHIP	SA
2203-005736	C512	C-CER,CHIP	SA
2203-005736	C513	C-CER,CHIP	SA
2203-006648	C542	C-CER,CHIP	SA

Main Electrical Parts List

SEC CODE	Design LOC	Discription	STATUS
2203-006194	C543	C-CER,CHIP	SA
2203-005682	C600	C-CER,CHIP	SA
2203-005736	C601	C-CER,CHIP	SA
2203-006194	C602	C-CER,CHIP	SA
2203-005806	C603	C-CER,CHIP	SA
2203-006556	C604	C-CER,CHIP	SA
2203-005682	C605	C-CER,CHIP	SA
2203-006423	C606	C-CER,CHIP	SA
2203-006648	C607	C-CER,CHIP	SA
2203-006423	C608	C-CER,CHIP	SA
2203-006194	C609	C-CER,CHIP	SA
2203-005792	C610	C-CER,CHIP	SA
2203-005792	C611	C-CER,CHIP	SA
2203-006318	C612	C-CER,CHIP	SA
2203-006318	C613	C-CER,CHIP	SA
2203-006318	C614	C-CER,CHIP	SA
2203-006318	C615	C-CER,CHIP	SA
2203-005736	C616	C-CER,CHIP	SA
2203-005736	C617	C-CER,CHIP	SA
2203-005736	C618	C-CER,CHIP	SA
2203-006556	C619	C-CER,CHIP	SA
2203-006318	C620	C-CER,CHIP	SA
2203-006423	C622	C-CER,CHIP	SA
2203-006194	C623	C-CER,CHIP	SA
2203-006423	C625	C-CER,CHIP	SA
2203-005682	C626	C-CER,CHIP	SA
2203-006620	C627	C-CER,CHIP	SNA
2203-005682	C628	C-CER,CHIP	SA
2203-005682	C629	C-CER,CHIP	SA
2203-005682	C630	C-CER,CHIP	SA
2203-006194	C631	C-CER,CHIP	SA
2203-006423	C632	C-CER,CHIP	SA
2203-006324	C633	C-CER,CHIP	SA
2203-005682	C635	C-CER,CHIP	SA
2203-005682	C636	C-CER,CHIP	SA
2203-006324	C637	C-CER,CHIP	SA
2203-006305	C638	C-CER,CHIP	SA
2203-005725	C639	C-CER,CHIP	SA
2203-006562	C640	C-CER,CHIP	SA
2203-006562	C641	C-CER,CHIP	SA
2203-005158	C642	C-CER,CHIP	SA
2901-001256	F101	FILTER-EMI SMD	SA

SEC CODE	Design LOC	Discription	STATUS
2901-001337	F500	FILTER-EMI/ESD	SA
2901-001337	F501	FILTER-EMI/ESD	SA
2901-001337	F502	FILTER-EMI/ESD	SA
2901-001337	F503	FILTER-EMI/ESD	SA
2901-001337	F504	FILTER-EMI/ESD	SA
2901-001337	F505	FILTER-EMI/ESD	SA
2901-001337	F506	FILTER-EMI/ESD	SA
2904-001592	F600	FILTER-SAW	SA
2904-001599	F601	FILTER-SAW	SA
2904-001601	F602	FILTER-SAW	SA
3711-006109	HDC500	HEADER-BOARD TO BOARD	SNA
3710-002306	IFC503	SOCKET-INTERFACE	SA
2703-002749	L100	INDUCTOR-SMD	SA
2703-002734	L101	INDUCTOR-SMD	SA
2007-000171	L300	R-CHIP	SA
2007-000171	L301	R-CHIP	SA
3301-001729	L302	BEAD-SMD	SA
2703-002485	L600	INDUCTOR-SMD	SA
2703-002544	L601	INDUCTOR-SMD	SA
2703-002608	L602	INDUCTOR-SMD	SA
2703-002917	L603	INDUCTOR-SMD	SA
2703-002917	L604	INDUCTOR-SMD	SA
2703-002558	L605	INDUCTOR-SMD	SA
2703-002313	L607	INDUCTOR-SMD	SA
2801-004466	OSC200	CRYSTAL-SMD	SA
2801-004225	OSC300	CRYSTAL-SMD	SA
2801-004455	OSC600	CRYSTAL-SMD	SA
2801-004426	OSC601	CRYSTAL-SMD	SA
1201-002278	PAM601	IC-POWER AMP	SA
0504-000168	Q100	TR-DIGITAL	SA
2007-008588	R100	R-CHIP	SA
2007-009166	R101	R-CHIP	SA
2007-008419	R102	R-CHIP	SA
2007-008055	R103	R-CHIP	SA
2007-000142	R104	R-CHIP	SA
2007-008483	R105	R-CHIP	SA
2007-008052	R106	R-CHIP	SA
2007-009167	R107	R-CHIP	SA
2007-008516	R108	R-CHIP	SA
2007-008483	R109	R-CHIP	SA
2007-008478	R110	R-CHIP	SA
2007-009115	R111	R-CHIP	SA

SEC CODE	Design LOC	Discription	STATUS
2007-009115	R112	R-CHIP	SA
2007-009212	R115	R-CHIP	SA
2007-000172	R201	R-CHIP	SA
2007-008531	R202	R-CHIP	SA
2007-008806	R203	R-CHIP	SA
2007-000162	R204	R-CHIP	SA
2007-008055	R205	R-CHIP	SA
2007-008483	R206	R-CHIP	SA
2007-008531	R207	R-CHIP	SA
2007-008055	R208	R-CHIP	SA
2007-000171	R210	R-CHIP	SA
2007-009084	R300	R-CHIP	SA
2007-000157	R301	R-CHIP	SA
2007-000171	R302	R-CHIP	SA
2007-008542	R304	R-CHIP	SA
2007-008531	R308	R-CHIP	SA
2007-008483	R309	R-CHIP	SA
2007-008516	R312	R-CHIP	SA
2007-008483	R313	R-CHIP	SA
2007-008051	R314	R-CHIP	SA
2007-009166	R315	R-CHIP	SA
2007-008055	R316	R-CHIP	SA
2007-009166	R317	R-CHIP	SA
2007-000138	R319	R-CHIP	SA
2007-009084	R320	R-CHIP	SA
2007-009169	R321	R-CHIP	SA
2007-009169	R322	R-CHIP	SA
2007-007310	R323	R-CHIP	SA
2007-008210	R326	R-CHIP	SA
2007-008210	R327	R-CHIP	SA
2203-006091	R328	C-CER,CHIP	SA
2203-006091	R329	C-CER,CHIP	SA
2007-009084	R330	R-CHIP	SA
2007-009084	R331	R-CHIP	SA
2007-000171	R400	R-CHIP	SA
2007-001292	R403	R-CHIP	SA
2007-001292	R406	R-CHIP	SA
2007-008420	R409	R-CHIP	SA
2007-008420	R410	R-CHIP	SA
2007-001119	R411	R-CHIP	SA
2007-007528	R412	R-CHIP	SA
2007-007528	R413	R-CHIP	SA

SEC CODE	Design LOC	Discription	STATUS
2007-007590	R414	R-CHIP	SA
2007-007142	R415	R-CHIP	SA
2007-007590	R416	R-CHIP	SA
2007-007142	R417	R-CHIP	SA
2007-007107	R418	R-CHIP	SA
2007-007107	R419	R-CHIP	SA
2007-007142	R420	R-CHIP	SA
2007-007142	R421	R-CHIP	SA
2007-007798	R426	R-CHIP	SA
2007-007798	R427	R-CHIP	SA
2007-007528	R428	R-CHIP	SA
2007-007588	R429	R-CHIP	SA
2007-001119	R430	R-CHIP	SA
2007-008542	R431	R-CHIP	SA
2007-008055	R432	R-CHIP	SA
2007-008055	R433	R-CHIP	SA
2007-000171	R434	R-CHIP	SA
2007-000171	R435	R-CHIP	SA
2007-000171	R436	R-CHIP	SA
2007-000171	R437	R-CHIP	SA
2007-008055	R500	R-CHIP	SA
2007-008419	R501	R-CHIP	SA
2007-008419	R502	R-CHIP	SA
2007-008419	R503	R-CHIP	SA
2007-008055	R504	R-CHIP	SA
2007-008419	R505	R-CHIP	SA
2007-008786	R506	R-CHIP	SA
2007-008786	R507	R-CHIP	SA
2007-008806	R508	R-CHIP	SA
2007-008806	R509	R-CHIP	SA
2007-008806	R510	R-CHIP	SA
2007-008806	R511	R-CHIP	SA
2007-008806	R512	R-CHIP	SA
2007-008806	R513	R-CHIP	SA
2007-008806	R514	R-CHIP	SA
2007-008806	R515	R-CHIP	SA
2007-008806	R516	R-CHIP	SA
2007-008806	R517	R-CHIP	SA
2007-008806	R518	R-CHIP	SA
2007-008542	R519	R-CHIP	SA
2007-008419	R522	R-CHIP	SA
2007-008419	R523	R-CHIP	SA

SEC CODE	Design LOC	Discription	STATUS
2007-008045	R524	R-CHIP	SA
2007-008806	R525	R-CHIP	SA
2007-008483	R526	R-CHIP	SA
2007-008548	R600	R-CHIP	SA
2007-008587	R601	R-CHIP	SA
2007-008045	R602	R-CHIP	SA
2007-008516	R603	R-CHIP	SA
2007-008516	R605	R-CHIP	SA
2007-008542	R606	R-CHIP	SA
2007-000171	R634	R-CHIP	SA
3705-001358	RFS600	CONNECTOR-COAXIAL	SA
3709-001421	SIM100	CONNECTOR-CARD EDGE	SA
3708-002170	SLC504	CONNECTOR-FPC/FFC/PIC	SA
2404-001381	TA100	C-TA,CHIP	SA
2404-001339	TA101	C-TA,CHIP	SA
2404-001381	TA103	C-TA,CHIP	SA
2404-001375	TA200	C-TA,CHIP	SA
2404-001225	TA300	C-TA,CHIP	SA
2404-001353	TA301	C-TA,CHIP	SA
2404-001353	TA302	C-TA,CHIP	SA
2404-001339	TA303	C-TA,CHIP	SA
2404-001381	TA304	C-TA,CHIP	SA
2404-001381	TA305	C-TA,CHIP	SA
2404-001240	TA400	C-TA,CHIP	SA
2404-001240	TA401	C-TA,CHIP	SA
2404-001225	TA402	C-TA,CHIP	SA
2404-001225	TA403	C-TA,CHIP	SA
2404-001352	TA404	C-TA,CHIP	SA
2404-001377	TA405	C-TA,CHIP	SA
2404-001411	TA500	C-TA,CHIP	SA
2404-001411	TA503	C-TA,CHIP	SA
2404-001374	TA600	C-TA,CHIP	SA
1404-001165	TH100	THERMISTOR-NTC	SA
0504-001049	TR300	TR-DIGITAL	SA
1203-003920	U100	IC-POWER SUPERVISOR	SA
0801-002529	U101	IC-CMOS LOGIC	SA
1203-003109	U102	IC-BATTERY	SA
1205-002272	U103	IC-TRANSCEIVER	SA
1203-003523	U104	IC-POSI.FIXED REG.	SA
1203-003428	U105	IC-DC/DC CONVERTER	SA
1203-003434	U106	IC-DC/DC CONVERTER	SA
1203-003523	U107	IC-POSI.FIXED REG.	SA

SEC CODE	Design LOC	Discription	STATUS
1205-002612	U300	IC-CODEC	SA
1201-002233	U303	IC-AUDIO AMP	SA
1001-001261	U400	IC-ANALOG SWITCH	SA
1001-001306	U401	IC-ANALOG MULTIPLEX	SA
1205-002683	U600	IC-TRANSCEIVER	SA
4709-001368	U602	BLUETOOTH MODULE	SA
1203-003432	U603	IC-POSI.FIXED REG.	SA
1204-002309	UCD301	IC-MELODY	SA
1205-002681	UCD302	IC-CODEC	SA
GH09-00040A	UCP200	IC MICOM	SA
1108-000024	UME201	IC-MCP	SA
1405-001082	V400	VARISTOR	SA
1405-001082	VR200	VARISTOR	SA
1405-001082	VR401	VARISTOR	SA
1405-001082	VR402	VARISTOR	SA
1405-001082	VR403	VARISTOR	SA
1405-001082	VR404	VARISTOR	SA
1405-001082	VR500	VARISTOR	SA
1405-001082	VR501	VARISTOR	SA
1405-001082	VR502	VARISTOR	SA
1405-001082	VR503	VARISTOR	SA
1405-001082	VR504	VARISTOR	SA
1405-001082	VR505	VARISTOR	SA
1405-001082	VR506	VARISTOR	SA
1405-001082	VR507	VARISTOR	SA
1405-001082	VR508	VARISTOR	SA
1405-001082	VR509	VARISTOR	SA
1405-001082	VR510	VARISTOR	SA
1405-001082	VR511	VARISTOR	SA
1405-001082	VR512	VARISTOR	SA
1405-001082	VR513	VARISTOR	SA
1405-001082	VR514	VARISTOR	SA
1405-001082	VR515	VARISTOR	SA
1405-001121	VR516	VARISTOR	SA
1405-001121	VR517	VARISTOR	SA
1405-001121	VR518	VARISTOR	SA
1405-001082	VR519	VARISTOR	SA
1405-001082	VR520	VARISTOR	SA
1405-001082	VR521	VARISTOR	SA
1405-001082	VR522	VARISTOR	SA
1405-001082	VR523	VARISTOR	SA
1405-001082	VR524	VARISTOR	SA

SEC CODE	Design LOC	Discription	STATUS
1405-001082	VR525	VARISTOR	SA
1405-001121	VR526	VARISTOR	SA
1405-001082	VR527	VARISTOR	SA
0406-001190	ZD500	DIODE-TVS	SA
0406-001190	ZD501	DIODE-TVS	SA
0403-001547	ZD502	DIODE-ZENER	SA
0403-001411	ZD503	DIODE-ZENER	SA
0403-001427	ZD504	DIODE-ZENER	SA

7. Block Diagrams

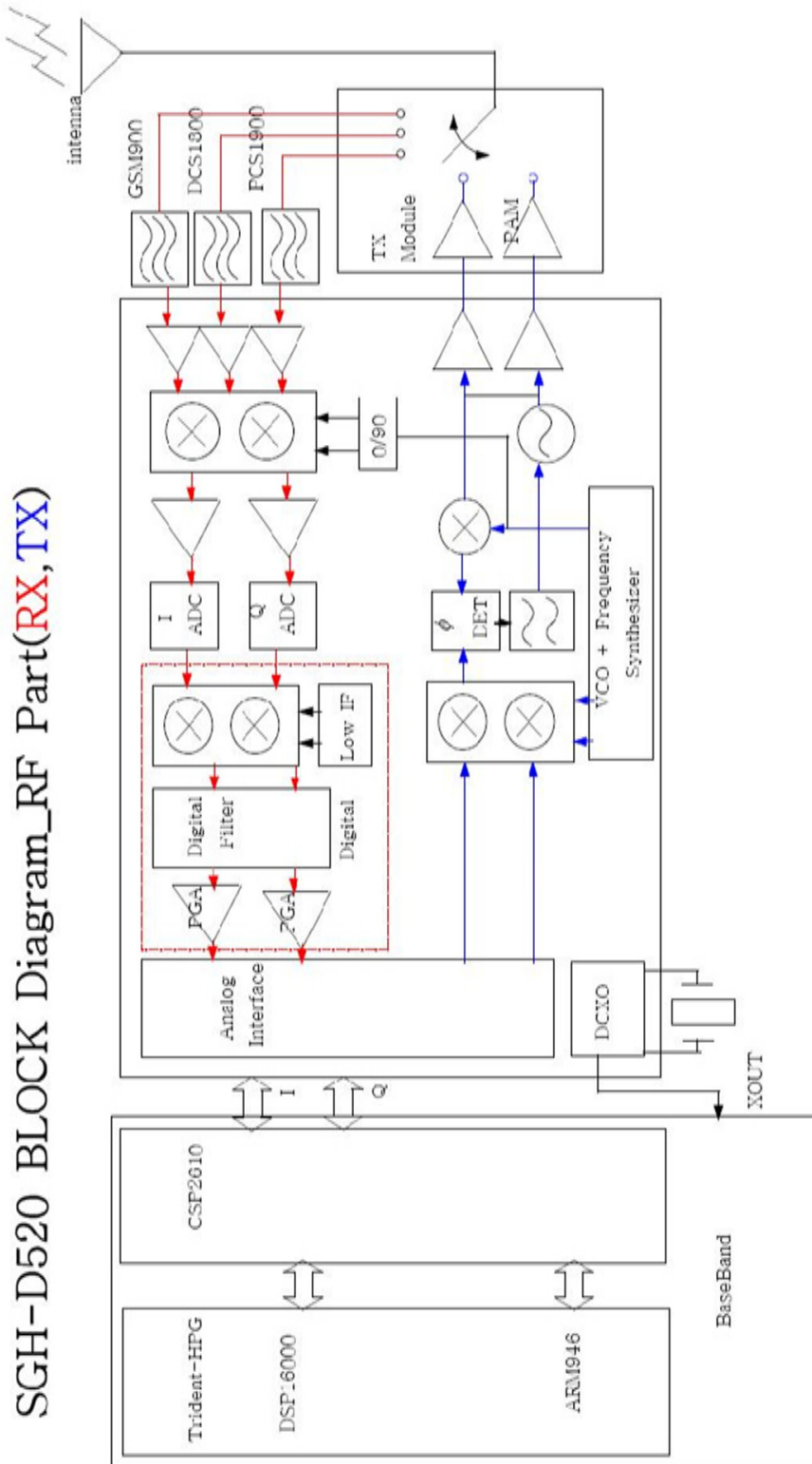

SGH-D520 BLOCK Diagram_BaseBand Part

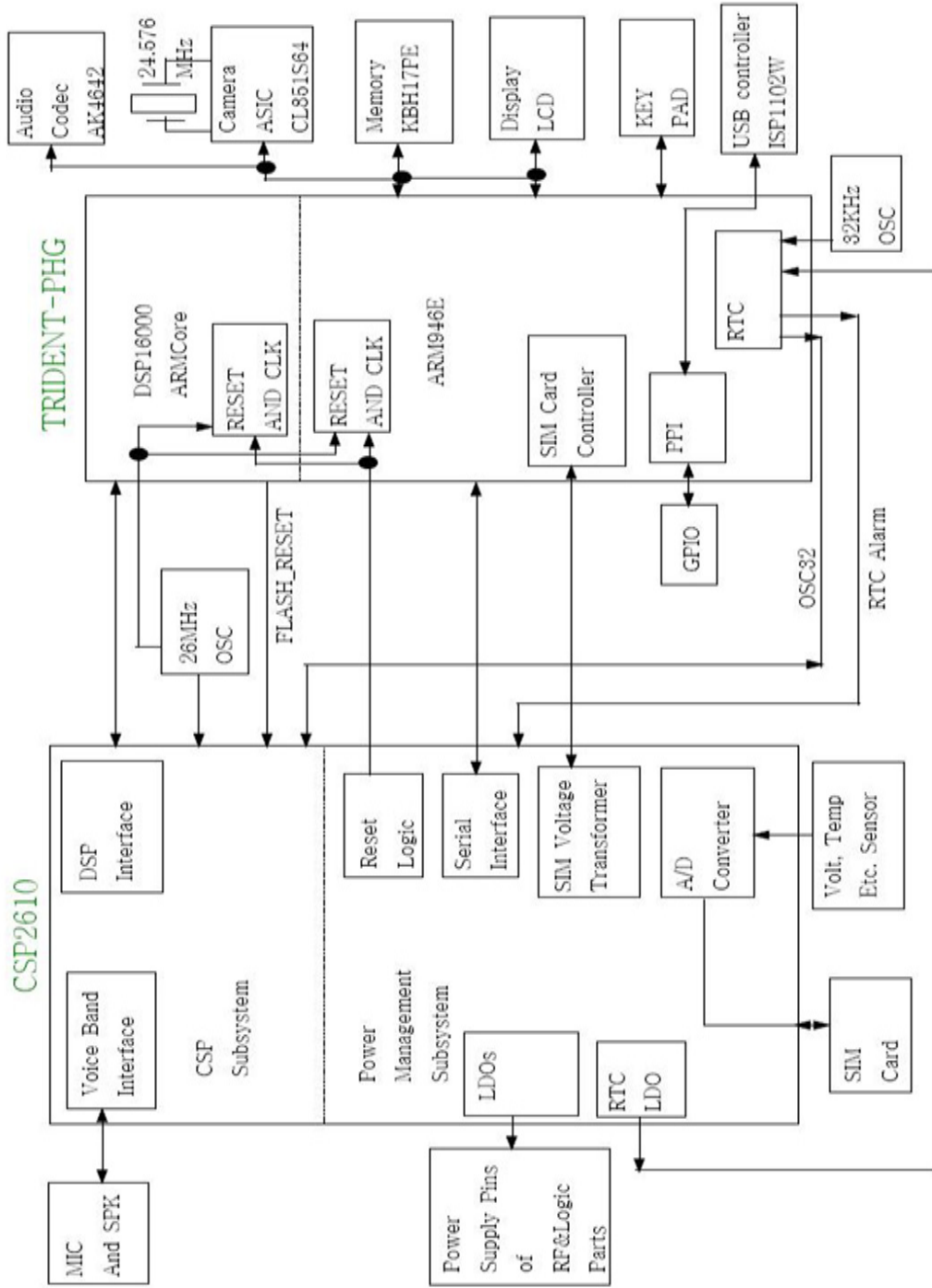

8. PCB Diagrams

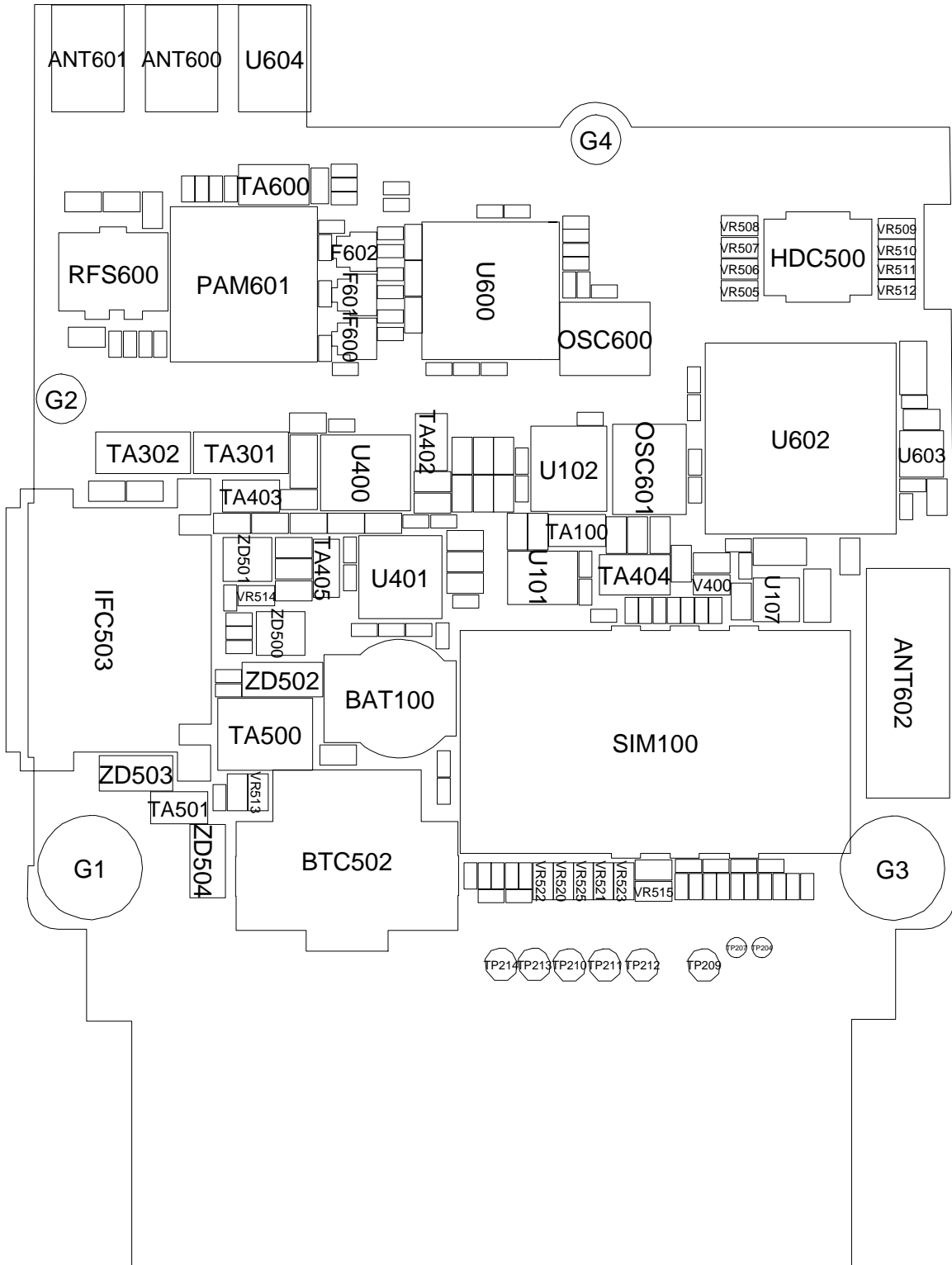

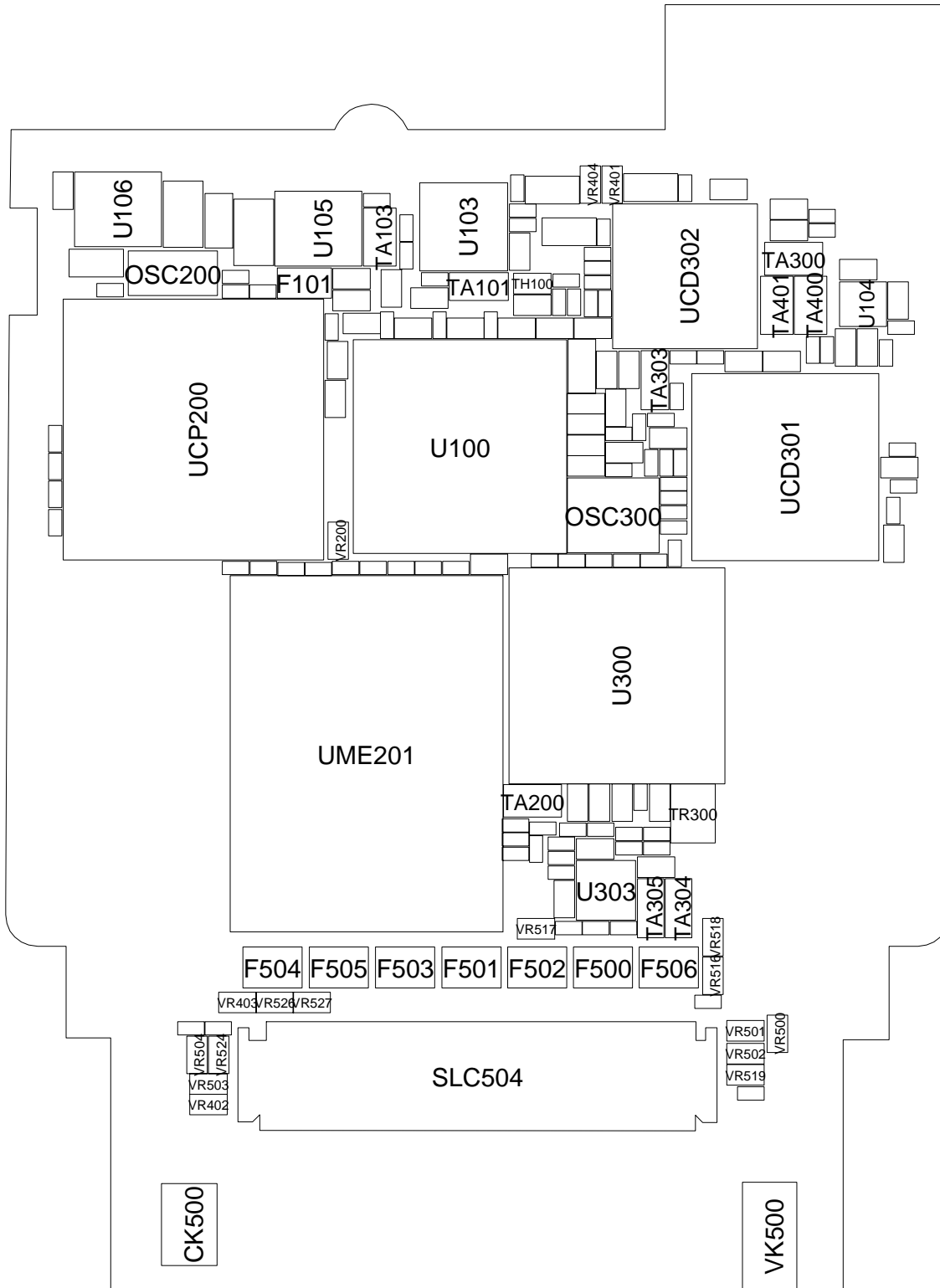

9. Flow Chart of Troubleshooting

9-1. Baseband

9-1-1. Power ON

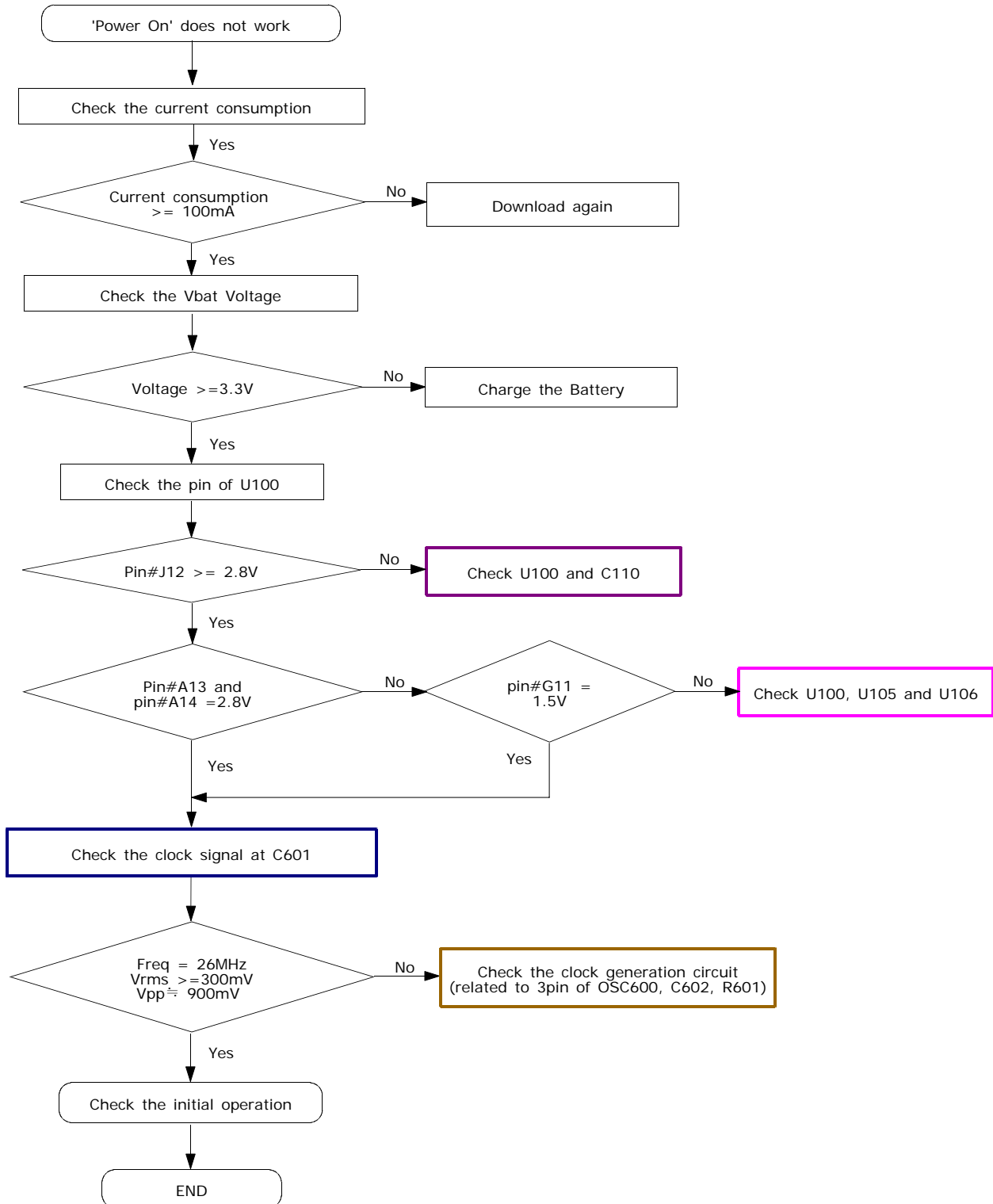

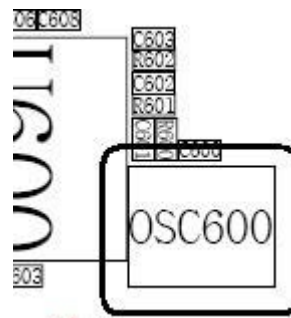
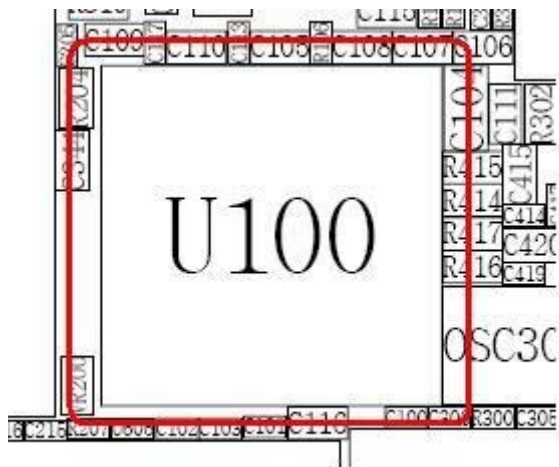
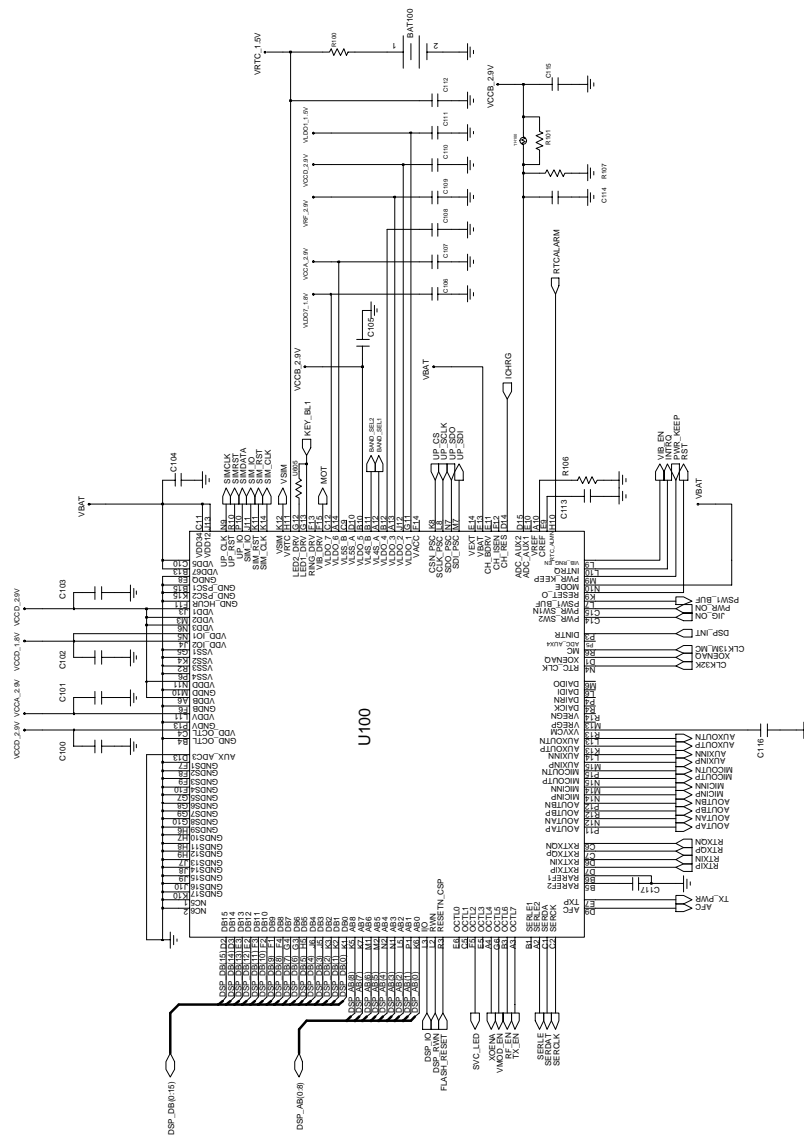

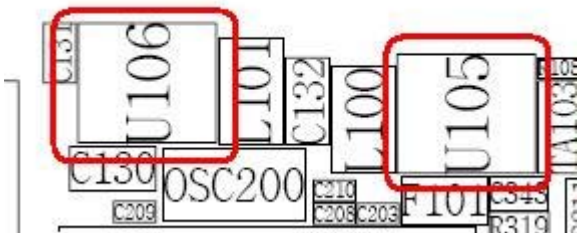
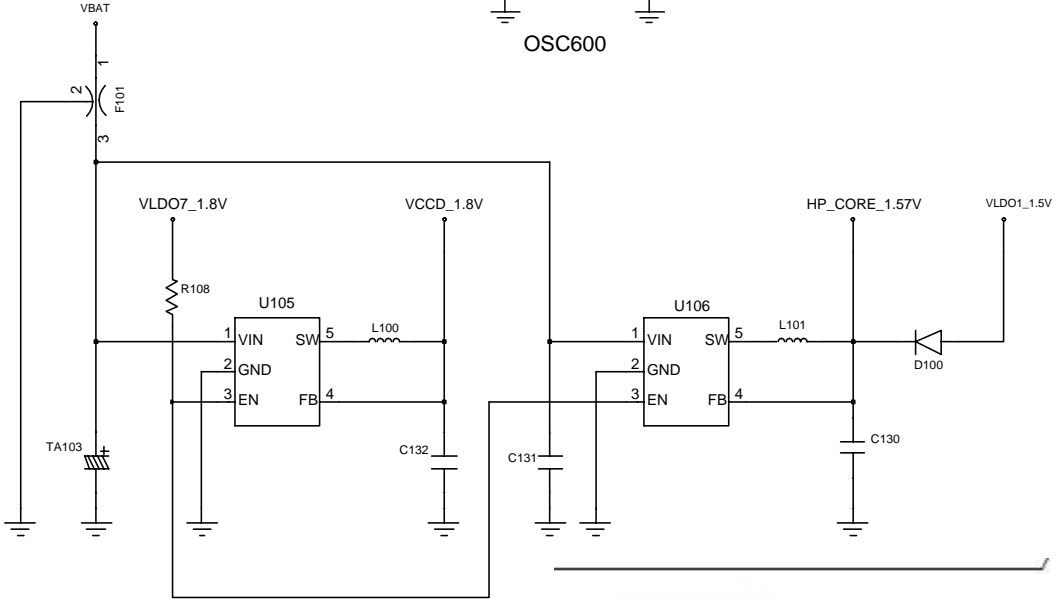
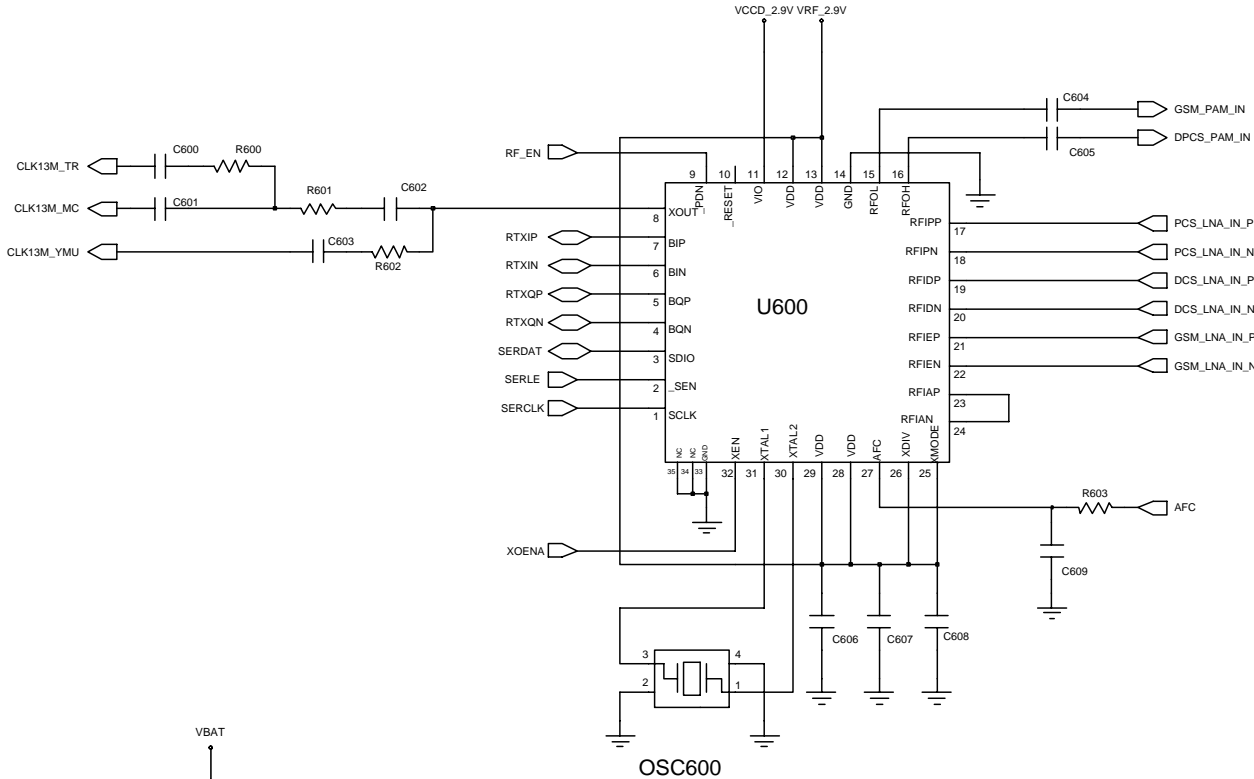

9-1-2. Initial

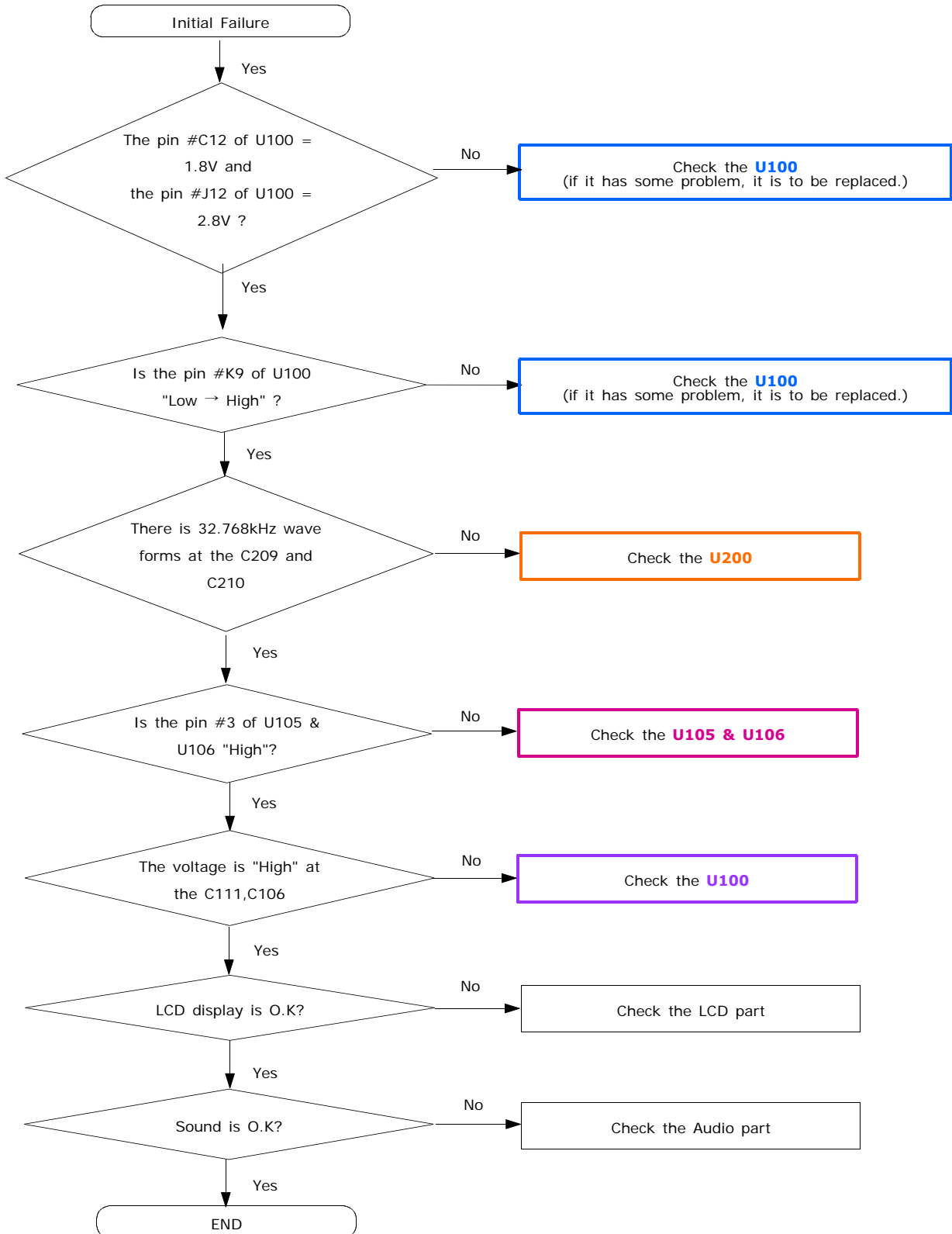

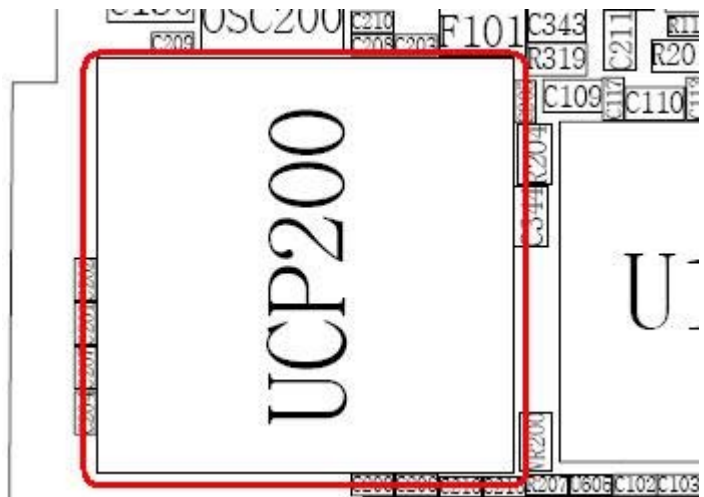
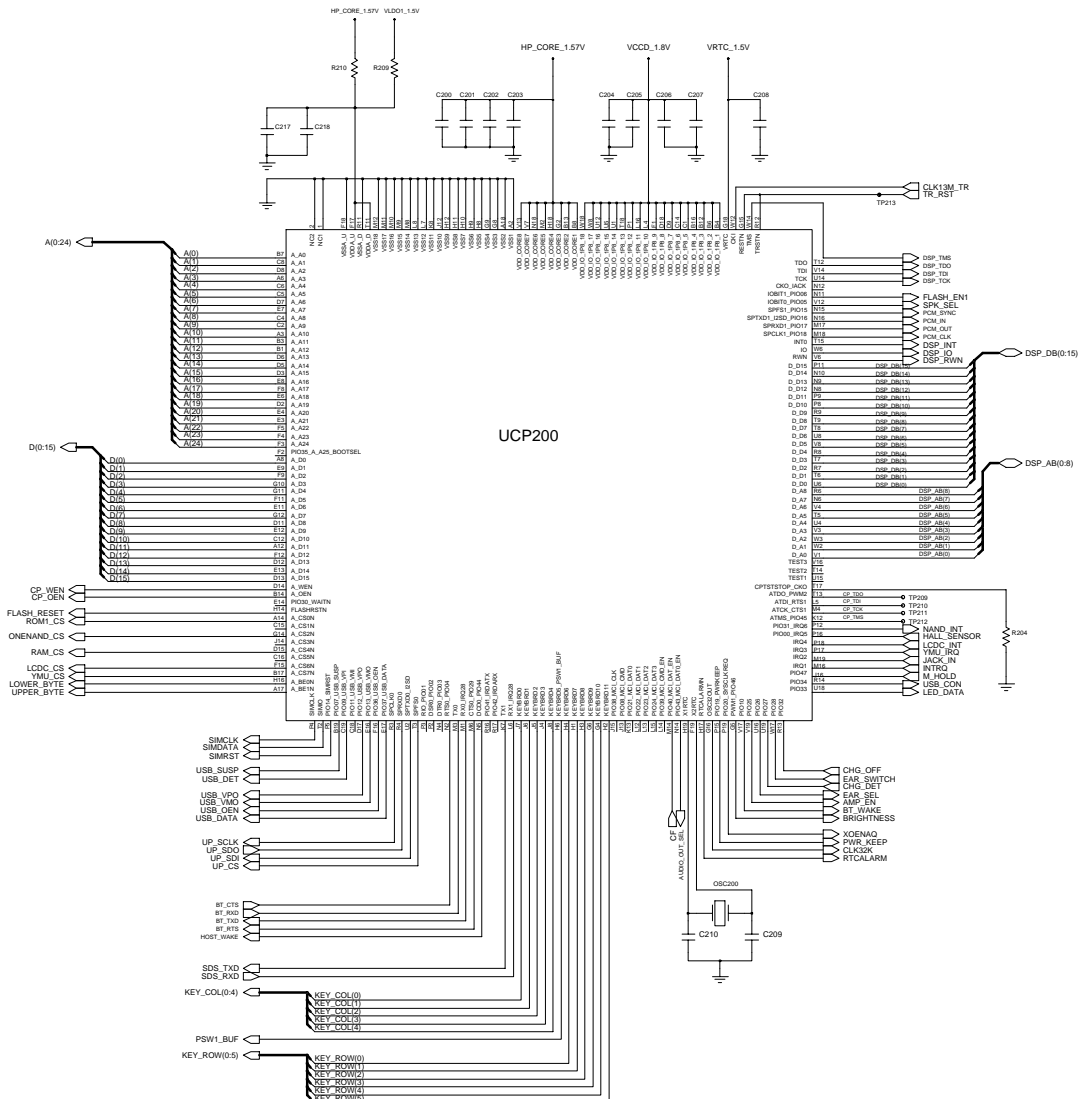

9-1-3. Sim Part

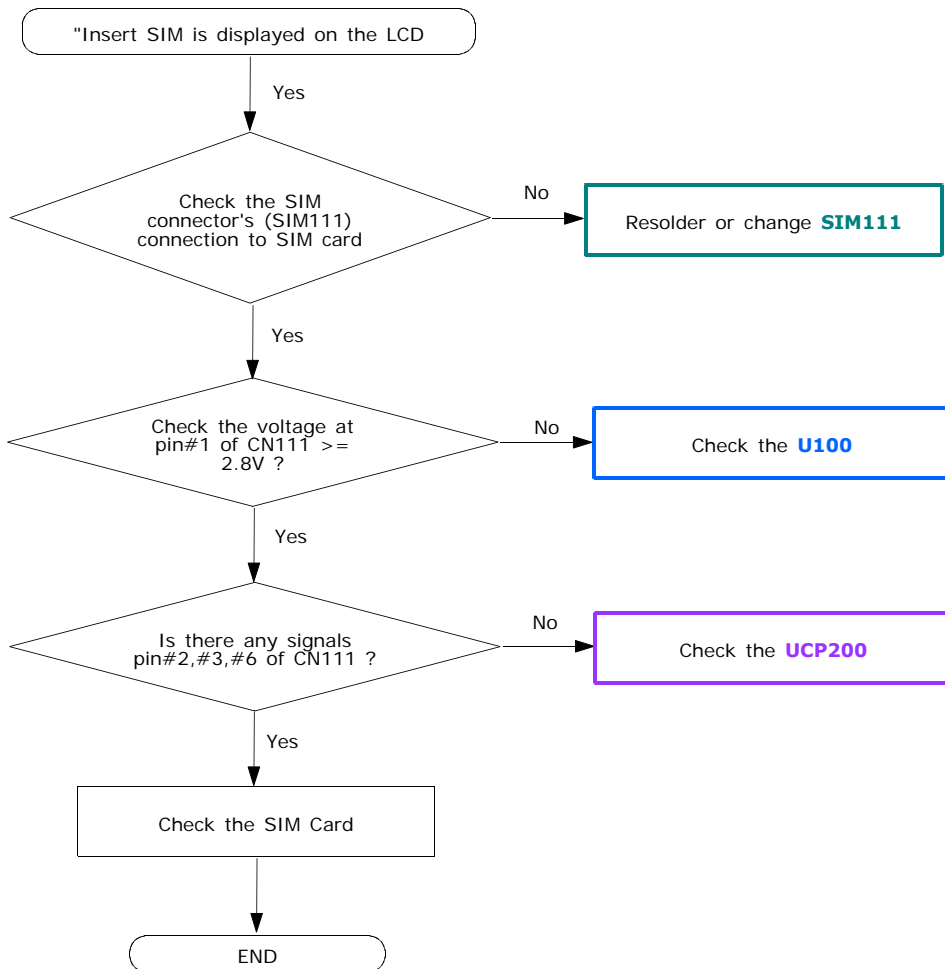

9-1-4. Microphone Part

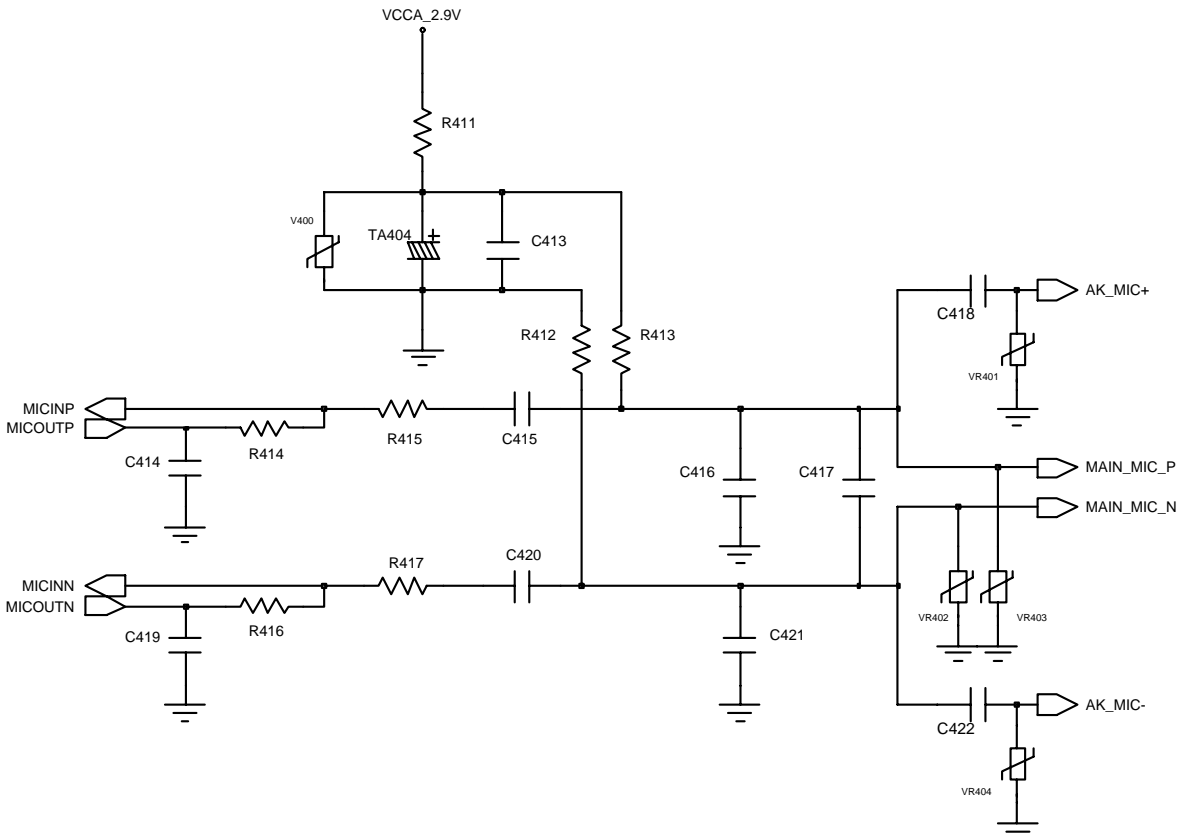
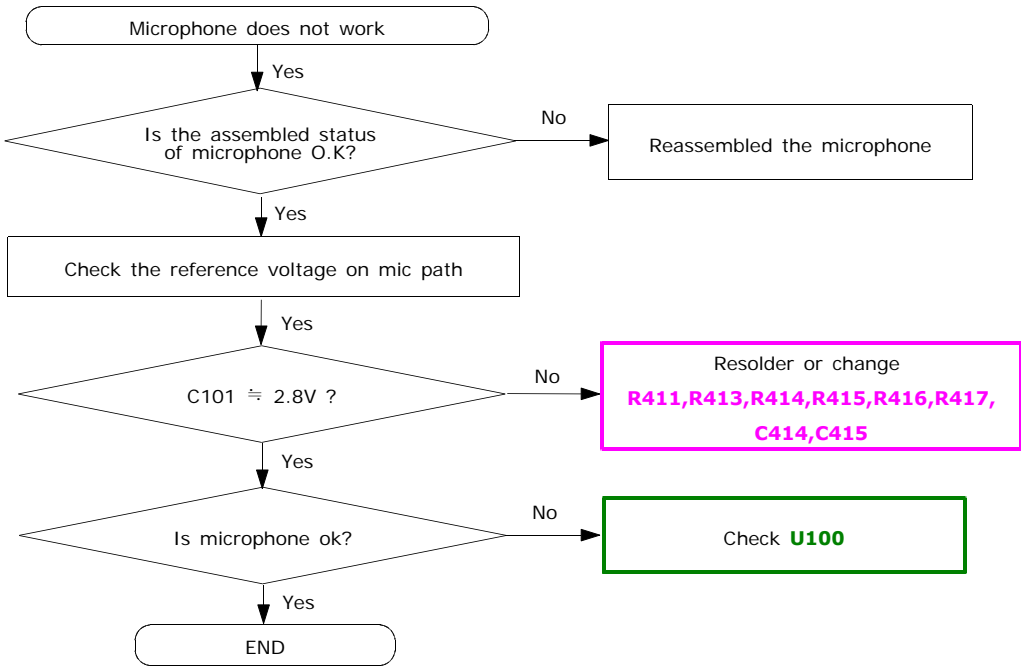

9-1-5. Speaker Part_1(MP3, SPEAKER PHONE)

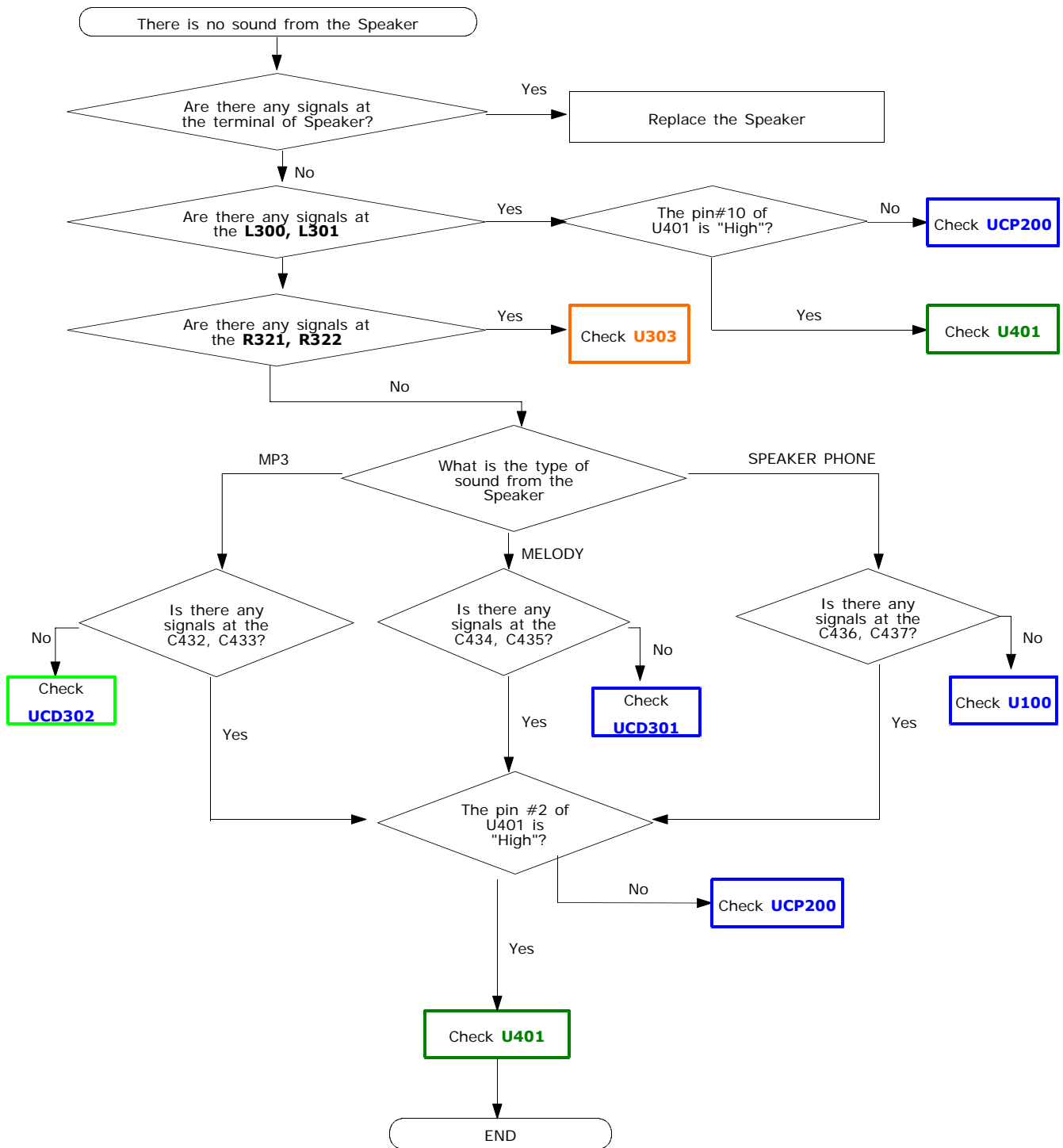

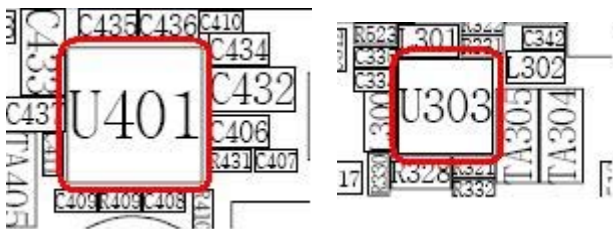
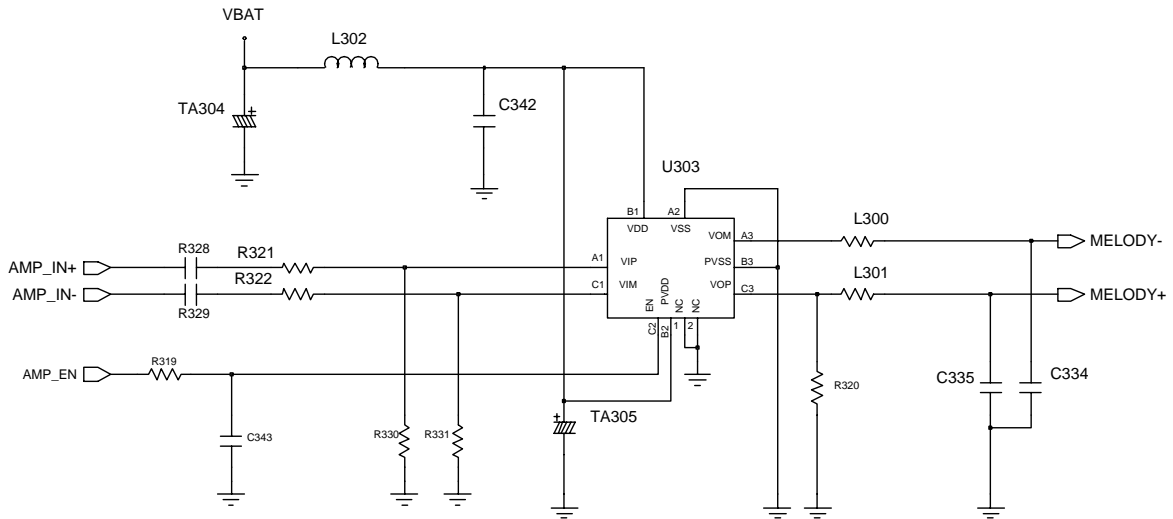
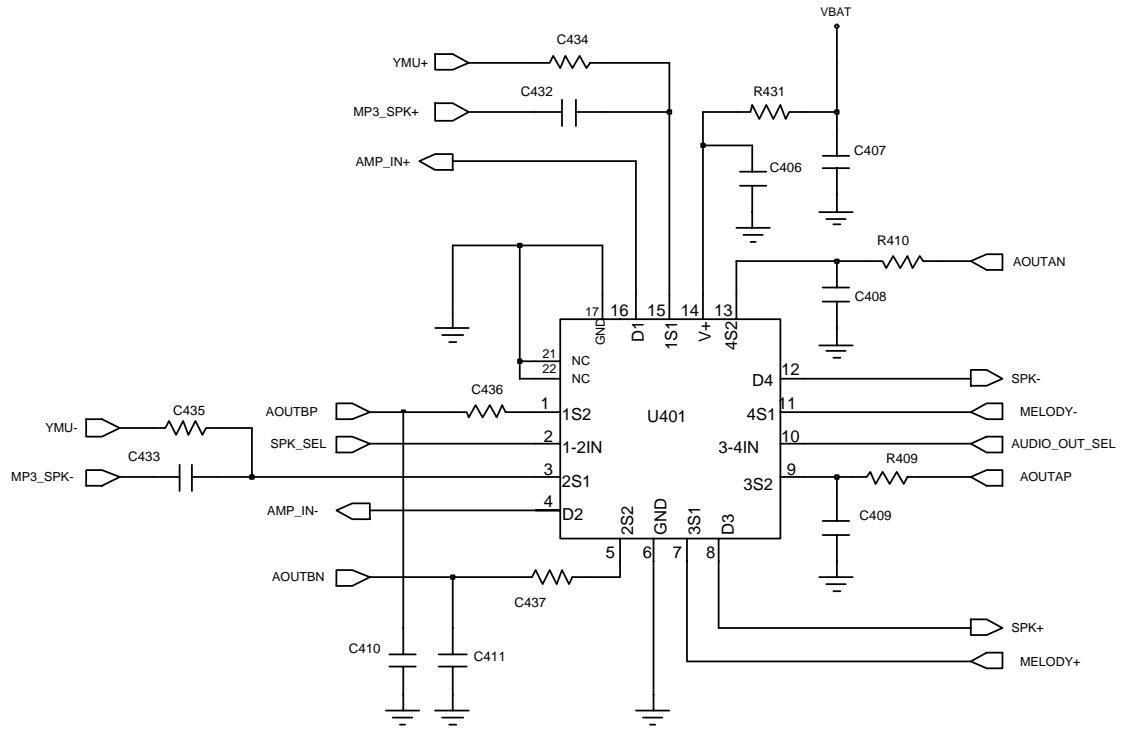

9-1-6. Speaker Part_2(RECEIVER)

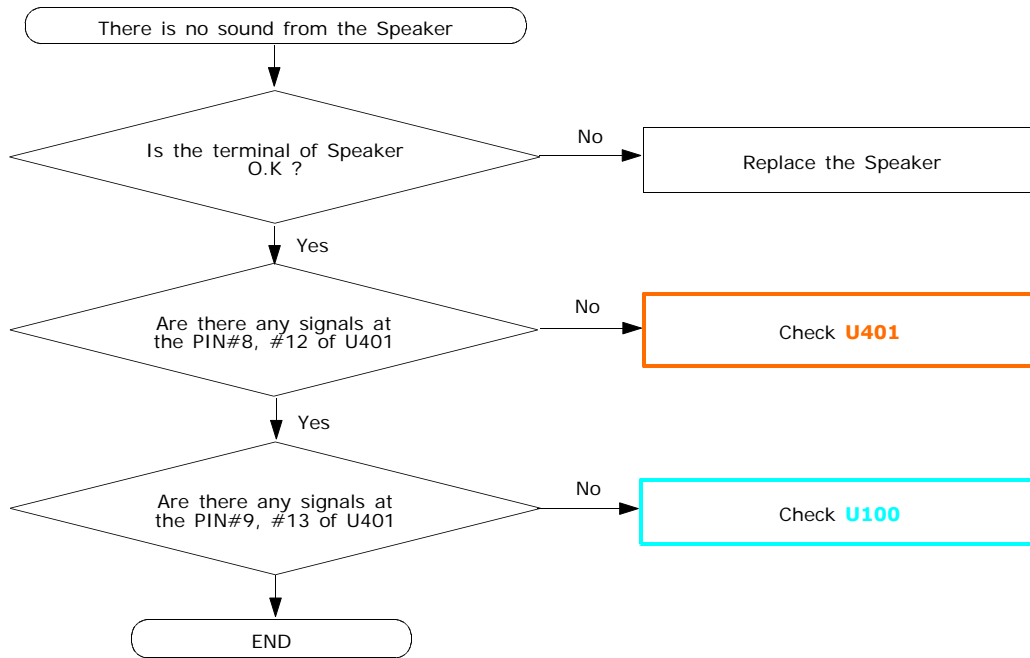

9-1-7. Charging Part

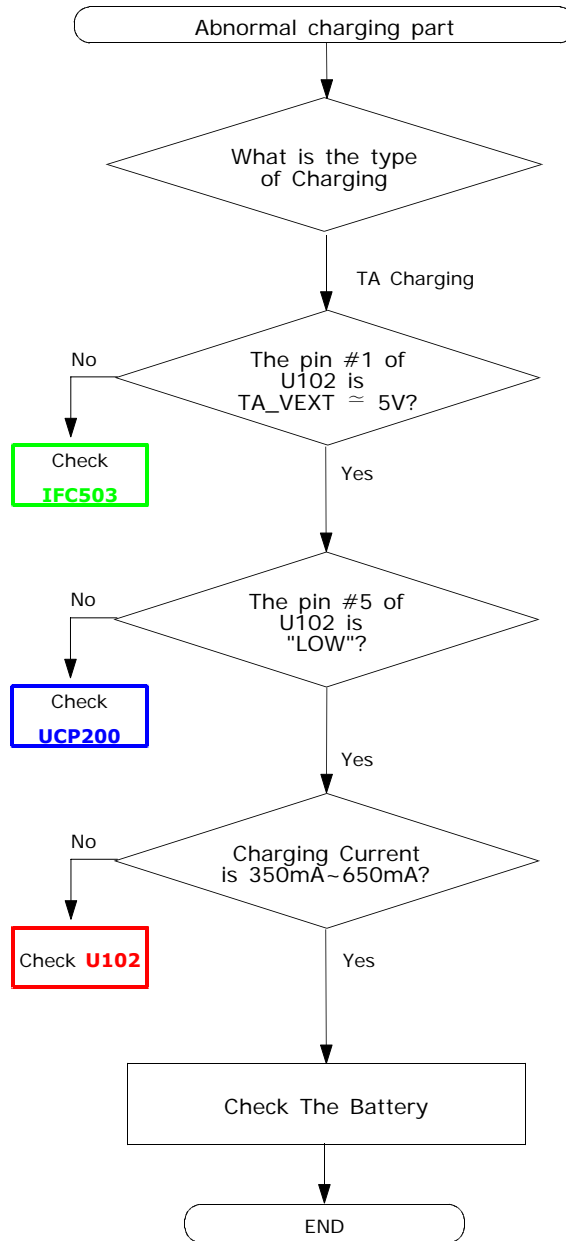

Flow Chart of Troubleshooting

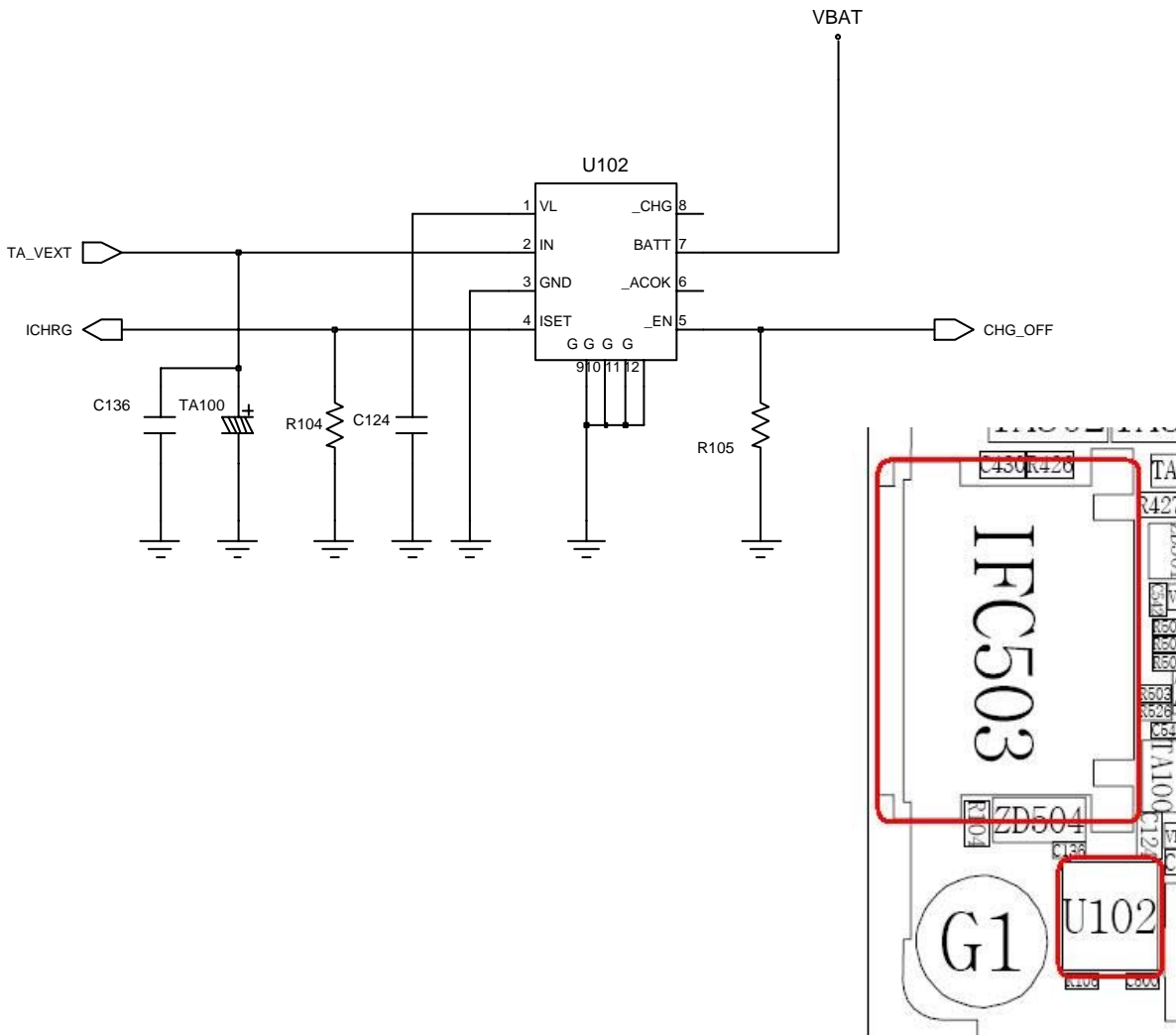
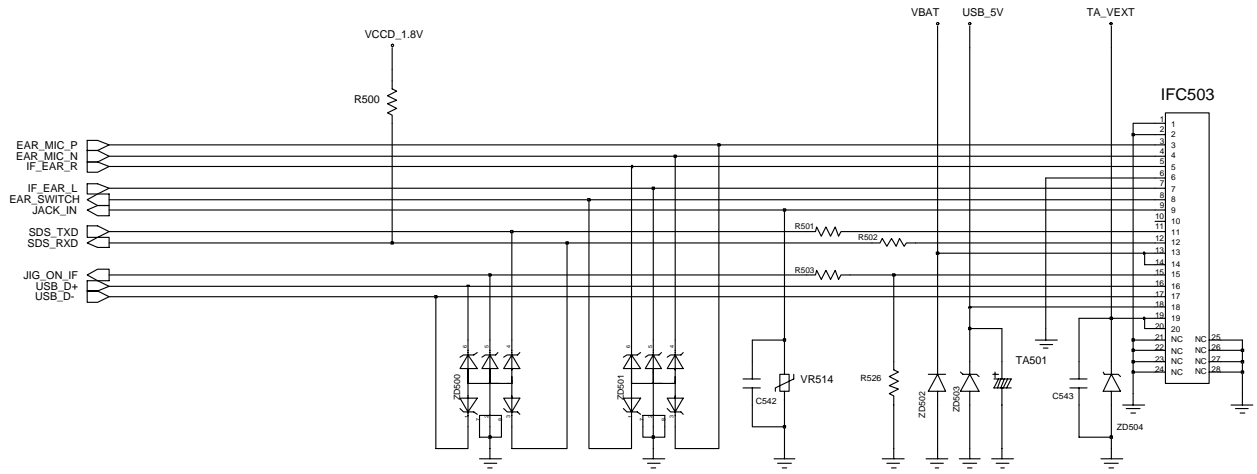

9-2. RF

9-2-1. EGSM RX

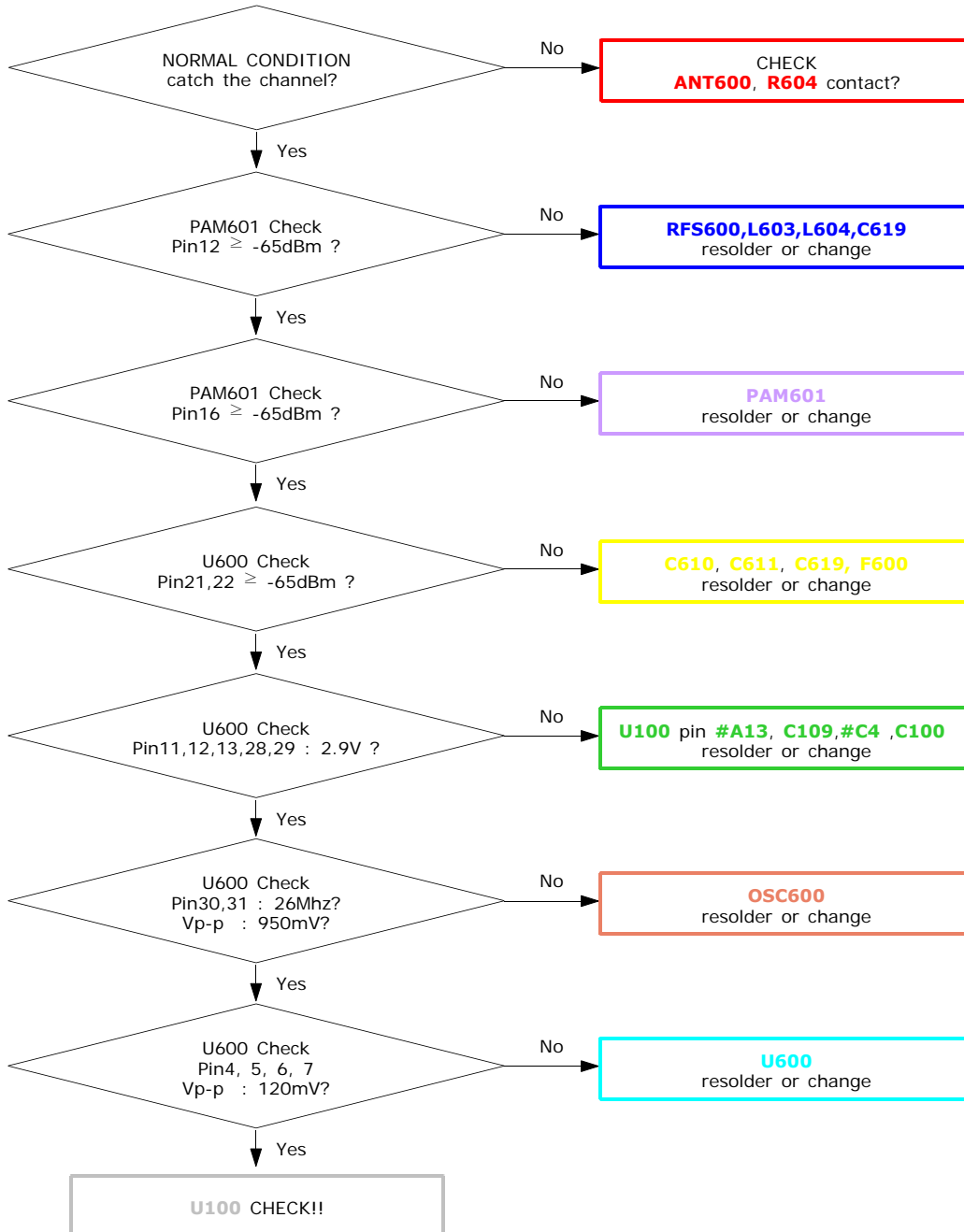

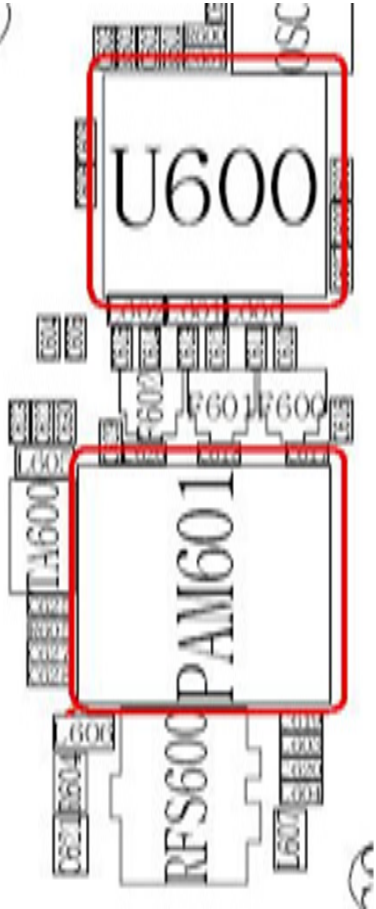
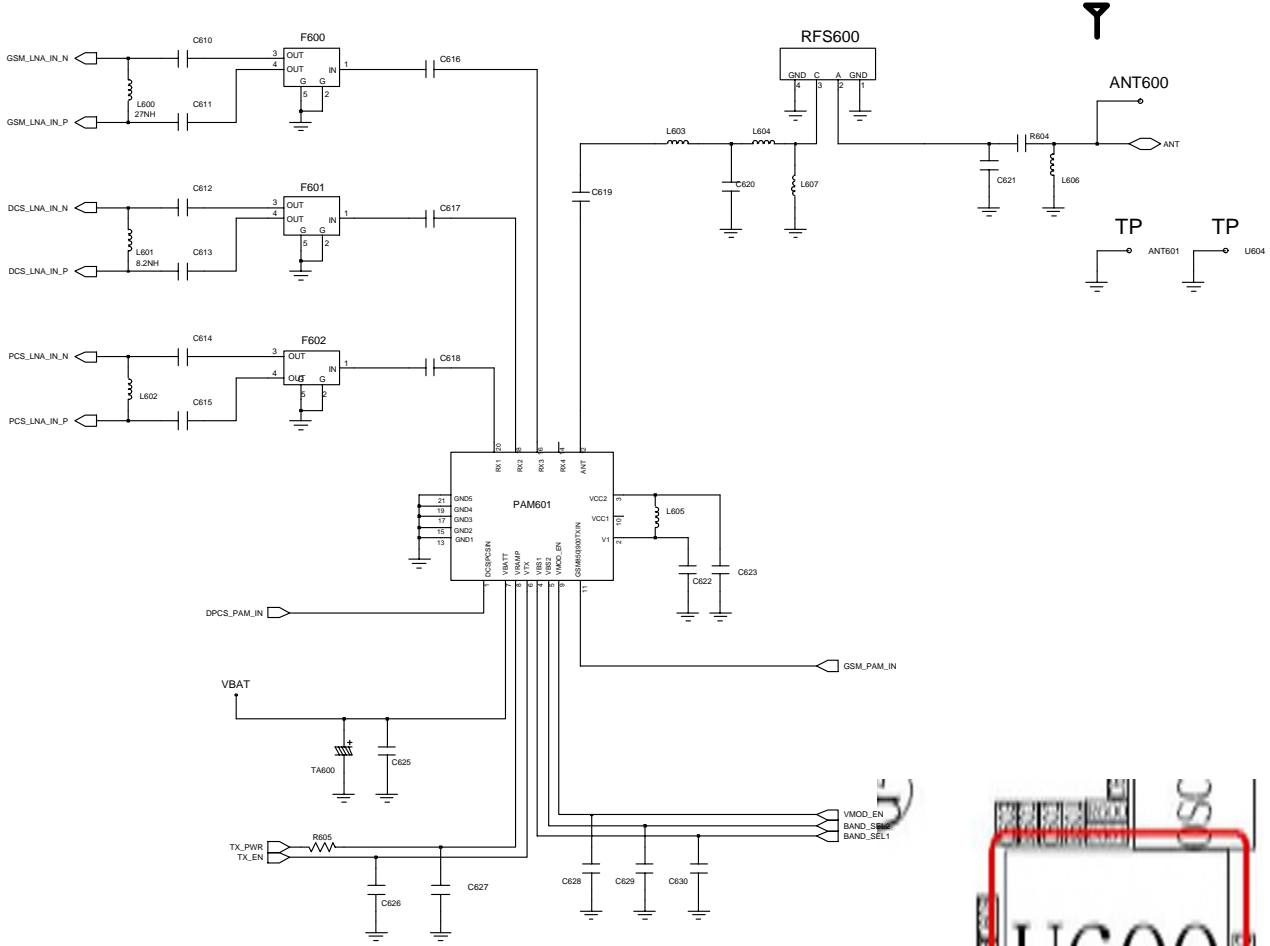

9-2-2. DCS RX

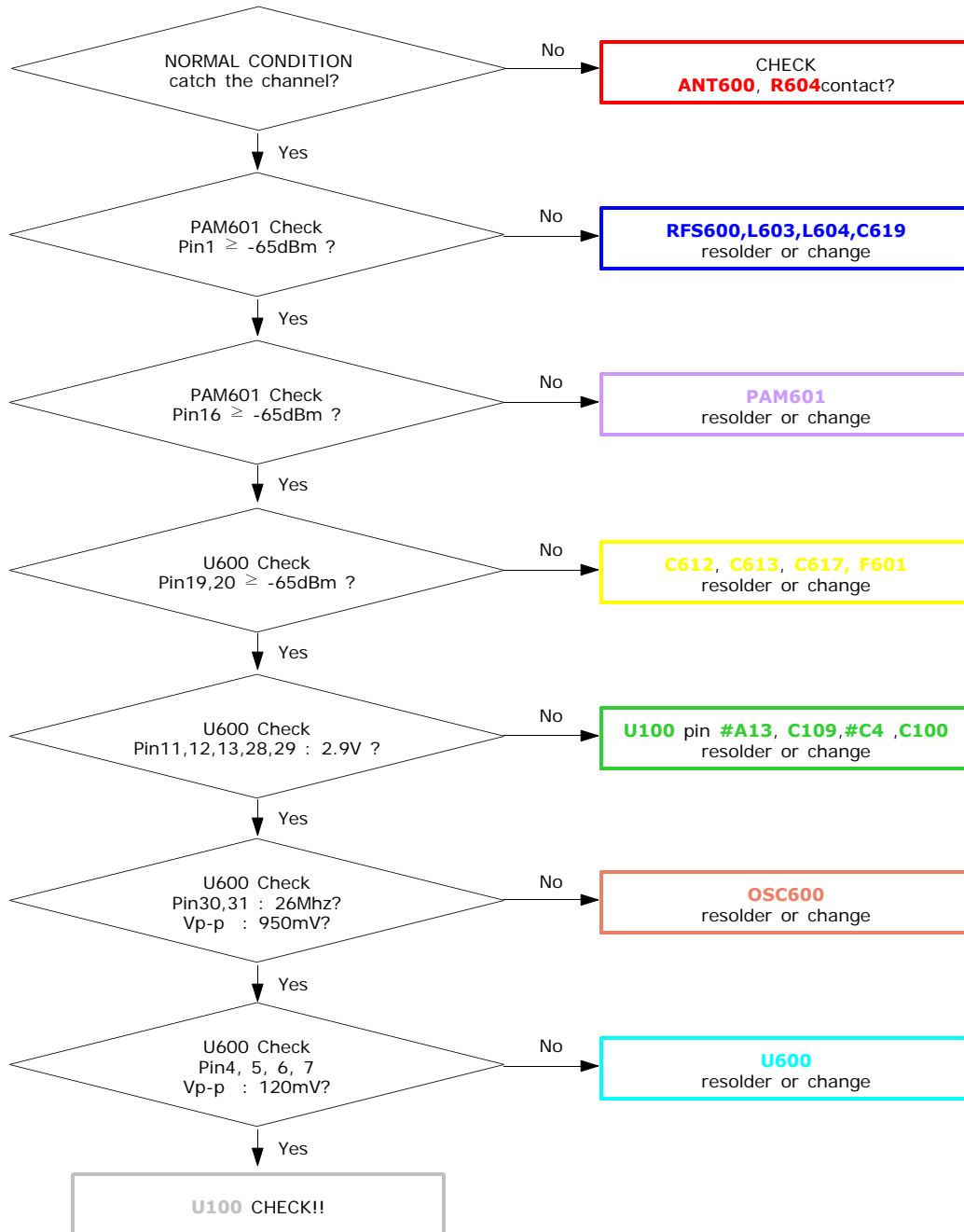

9-2-3. PCS RX

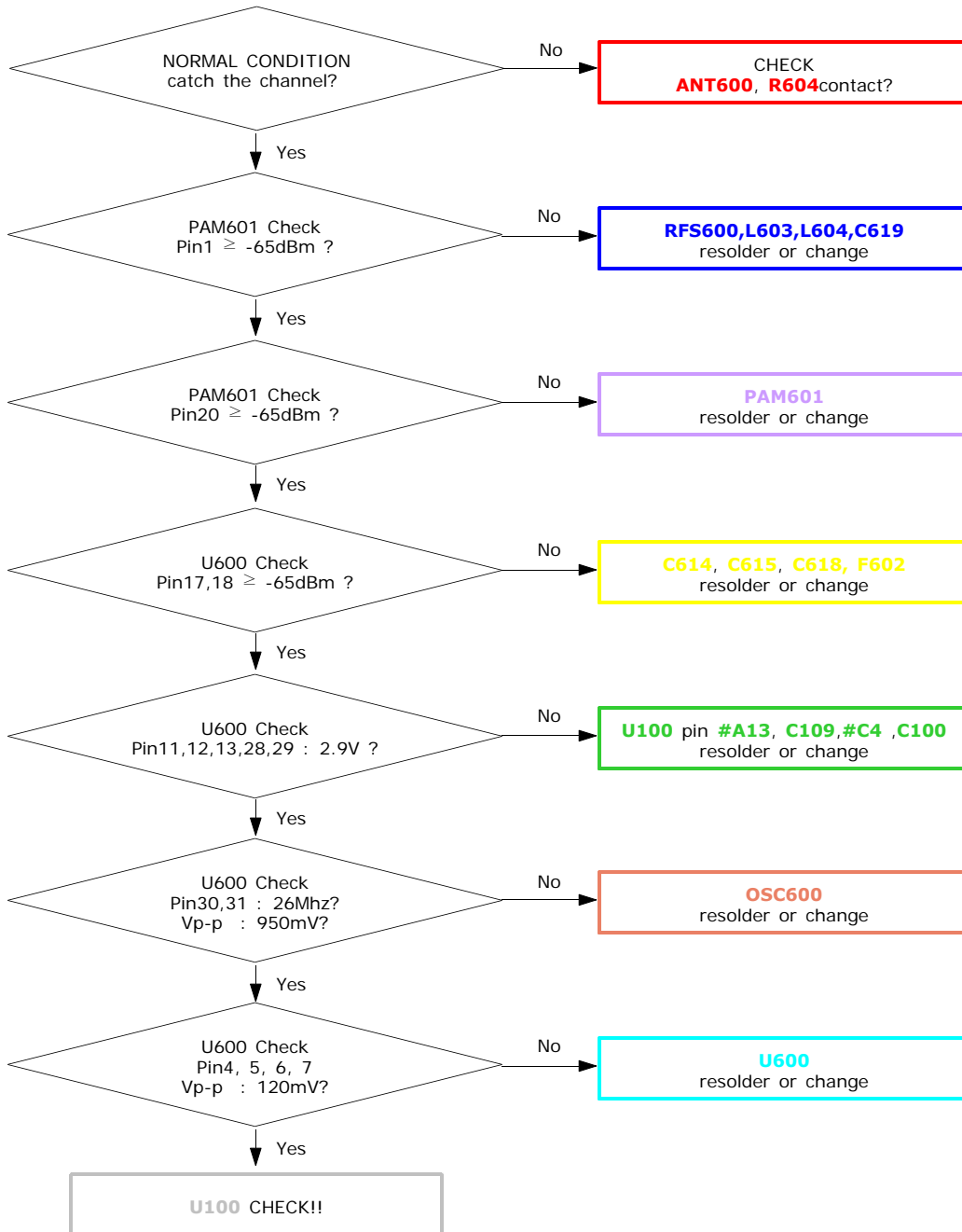

9-2-4. EGSM TX

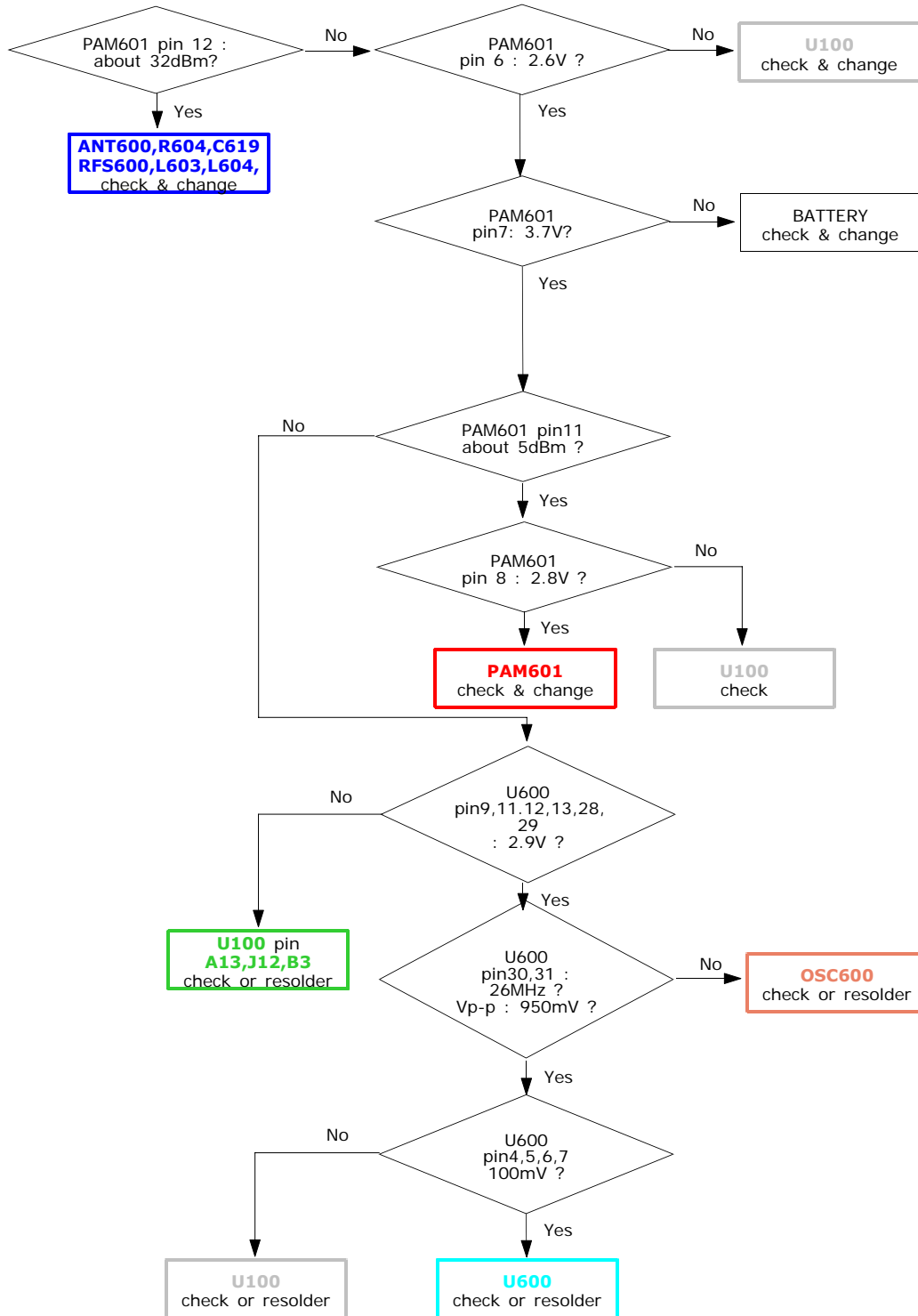

9-2-5. DCS TX

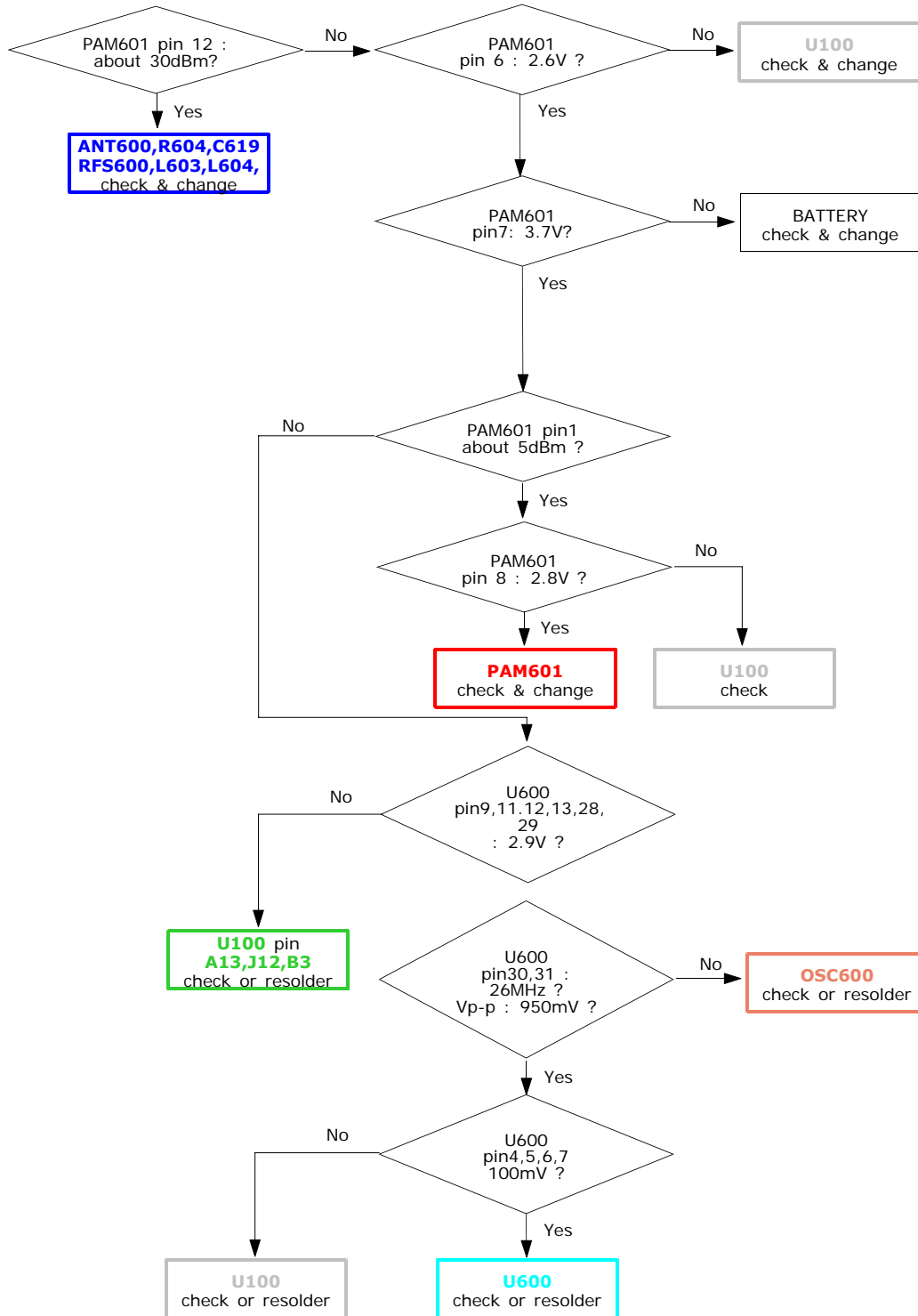

9-2-6. PCS TX

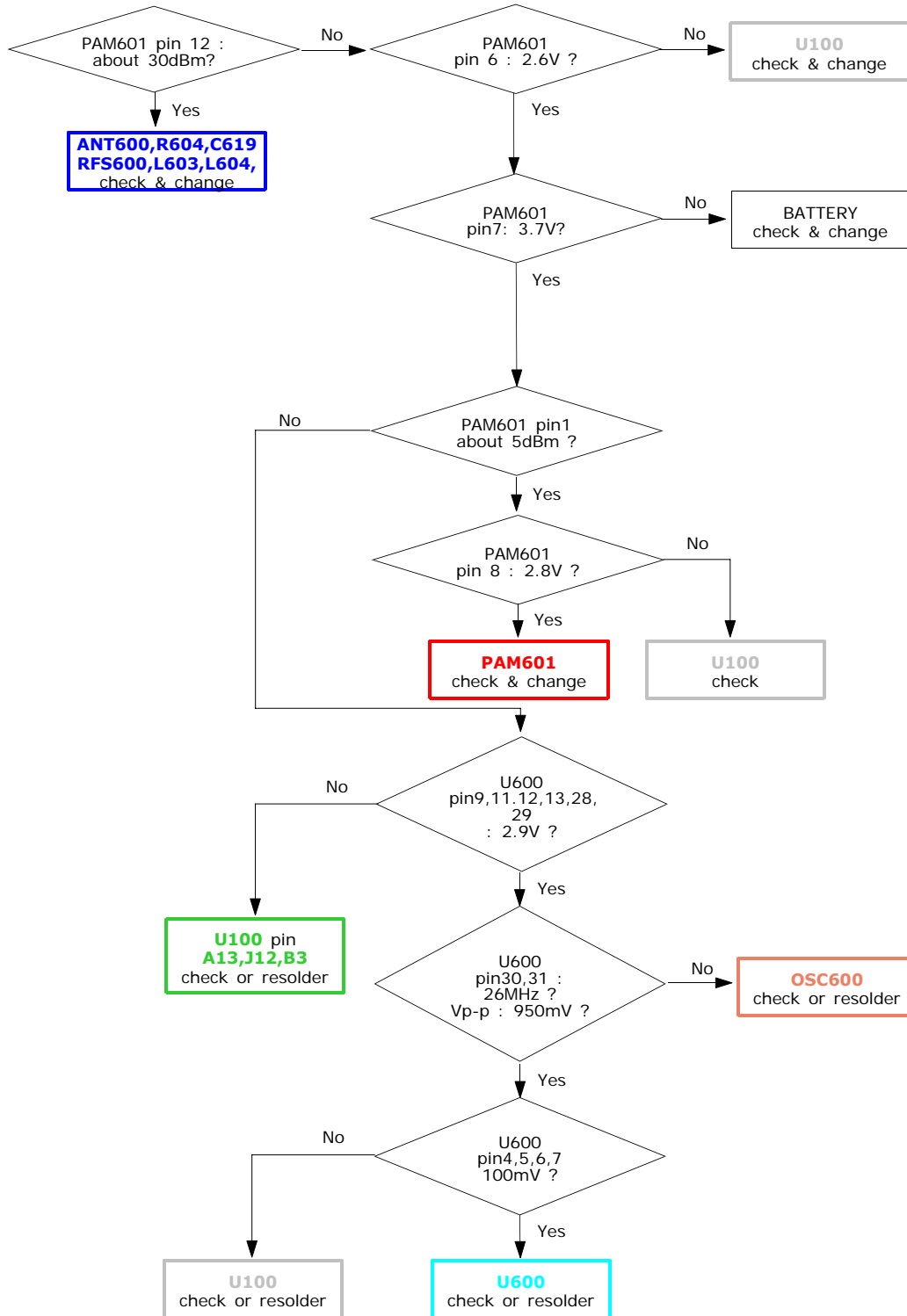

10. Reference data

10-1. Reference Abbreviate

AAC: Advanced Audio Coding.

AVC : Advanced Video Coding.

BER : Bit Error Rate

BPSK: Binary Phase Shift Keying

CA : Conditional Access

CDM : Code Division Multiplexing

C/I : Carrier to Interference

DMB : Digital Multimedia Broadcasting

EN : European Standard

ES : Elementary Stream

ETSI: European Telecommunications Standards Institute

MPEG: Moving Picture Experts Group

PN : Pseudo-random Noise

PS : Pilot Symbol

QPSK: Quadrature Phase Shift Keying

RS : Reed-Solomon

SI : Service Information

TDM : Time Division Multiplexing

TS : Transport Stream

11. Exploded and assembling View

11-1. Cellular phone Exploded View

WARNING

■ Put on straps and gloves to remove electricity

[disassemble lower part of SET]



[disassemble left part of SET]



[disassemble SET]



[final check]

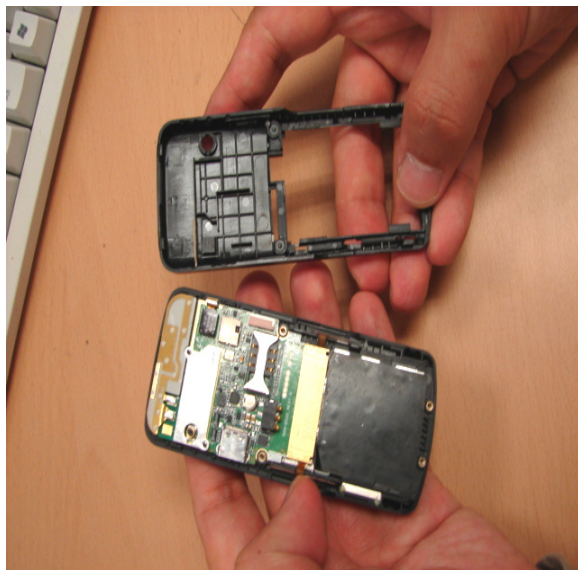

[remove MAIN FPCB connector]

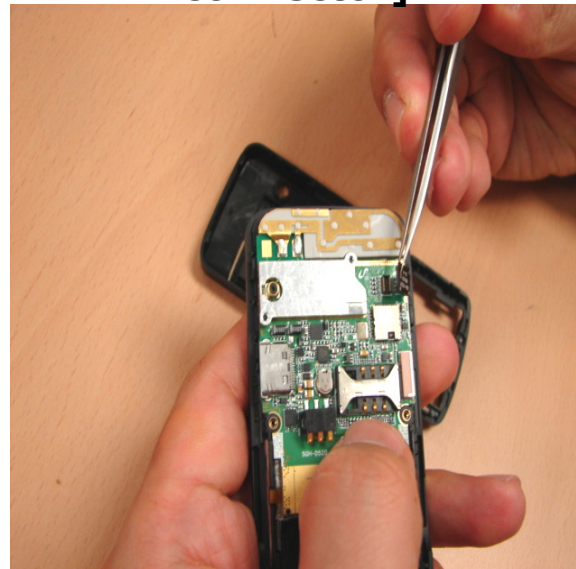

[disassemble right part of SET]

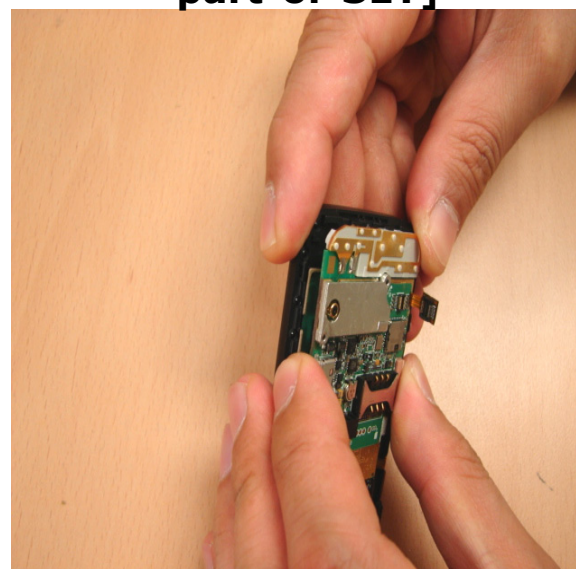

INSTRUMENTS TO BE USED

NO	MATERIAL	CODE	STANDARD	Quantity
1				
2				
3				
4				
5				
6				

Application S G H - D 5 2 0 / D 5 2 8

Subject		Work Description NO
DISASSEMBLY OF MAIN SET		25

ED	when to modify	what to modify
1		
2		
3		

11-2. Cellular phone assembling

Subject	Description	Confirmation and inspection standard
inspection	-Inspect the exterior of speaker	-check broken wires and exterior of speaker
inspection	-Inspect the exterior of motor	-check broken wires of motor
soldering	-Solder the speaker on board	-take care polarity and solder that(look at picture)
soldering	-Solder the motor on board	-take care polarity and solder that(look at picture)
glue	-apply the glue on part to solder	

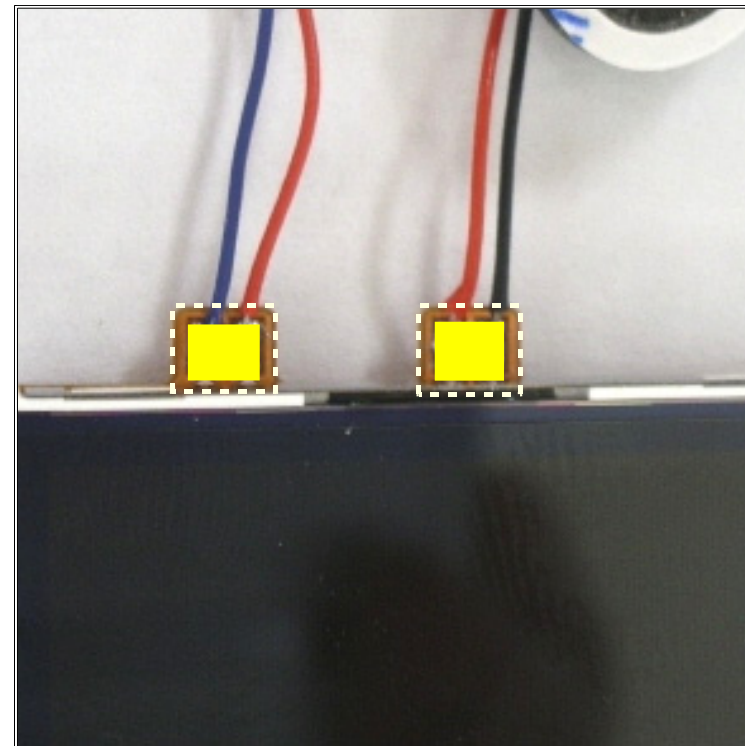
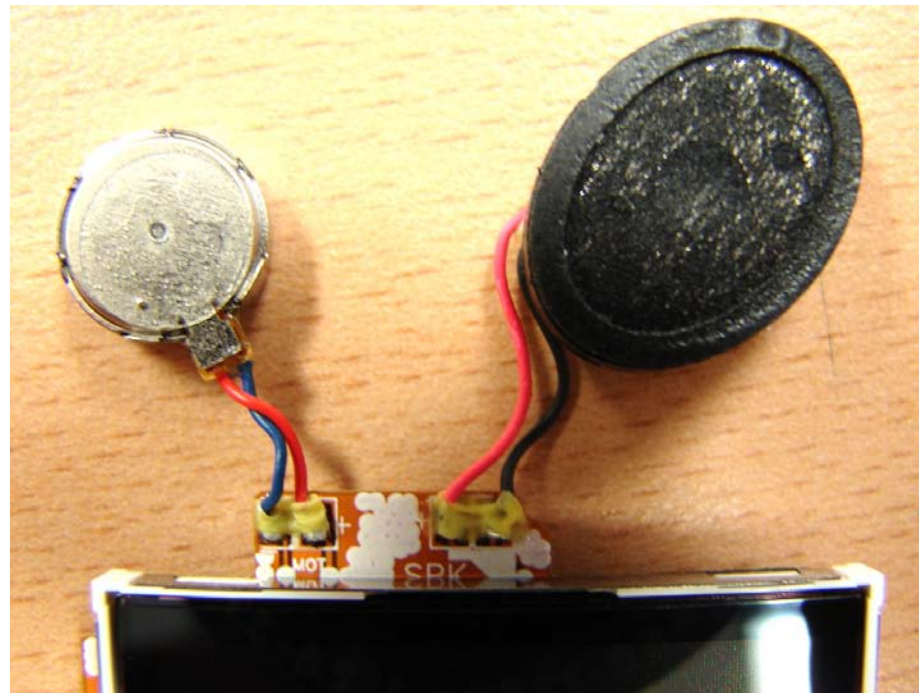

Warning

■ take care polarity of PAD when you solder speaker and receiver

INSTRUMENTS TO BE USED				
NO	MATERIAL	CODE	STANDARD	Quantity
1	speaker	3001-001906	8ohm,88+-2dB,800Hz	1EA
2	motor	GH31-00187A	90mA,10~55Hz,-2.5~3.5V/90~150mA	1EA
3	soldering iron	-	350 \pm 380	1EA
4	solder	-	SR-34 (PA TYPE)	1EA
5	JIG for soldering	-	D520/D528	1EA
6	strap	-	-	-
7	gloves	-	-	-
8				

Application		SGH-D520/D528	
Subject		Work Description NO	
soldering of motor and speaker		1	

ED	date of revision	Revision contents
1		
2		
3		
4		

Subject	Work contents	Confirmation and inspection standard
remove tape	-adhere tape on camera FPCB and remove the paper on tape	
connect camera	-camera connects with LCD connector.	-insert Silt line of camera FPCB and Silt line under connector that occupy space equally
adhere tape	-adhere tape on upper side of connector	

[adhere tape and remove the paper on tape]

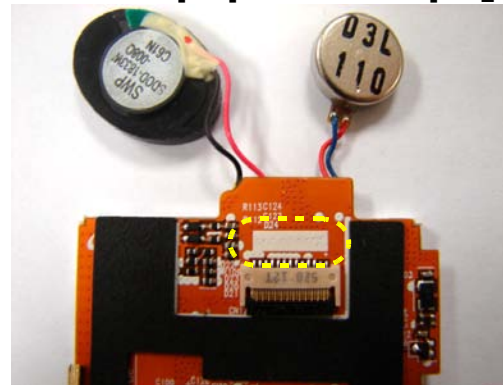

[connect camera]

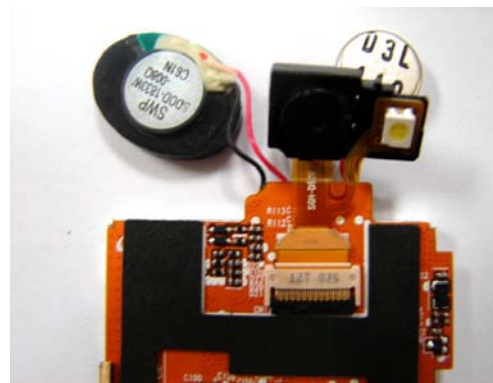

[adhere tape]

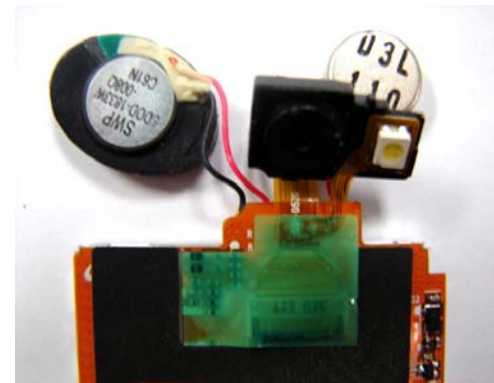

[enlargement]

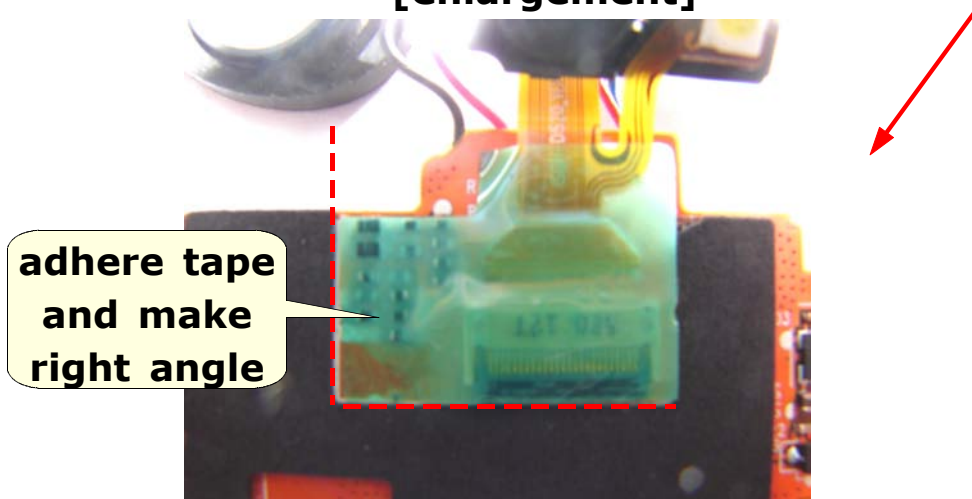

INSTRUMENTS TO BE USED				
NO	MATERIAL	CODE	STANDARD	Quan
1	CAMERA MODULE	GH59-02860A	1.5V/2.8V, 50mA	1
2	TAPE	GH74-21364A	17X9X0.085 T	1
3	TAPE	GH74-21362A	7X2X0.35T	1
4				
5				
6				

Application		SGH-D520/D528		
Subject			Work Description NO	
Connection of camera			2	

(ED)	date of revision	Revision contents
1		
2		
3		
4		

Subject	Work contents	Confirmation and inspection
remove	-adhere tape and remove paper on tape	
connect FPCB	-insert navi KEY into LCD connector -close black acuator	-Insert white silk and LCD connector that becomes to position equally
adhere tape	-adhere tape(like picture)	
adhere tape	-adhere sponge on left upper side of LCD	-Attach via sticking page lower column department silk.
Sponge	-adhere sponge(like picture)	-Attach to the top portion via red.

Warning

Do to do sticking progress from sticking standard at TAPE sticking.

[adhere tape and remove the paper on tape]

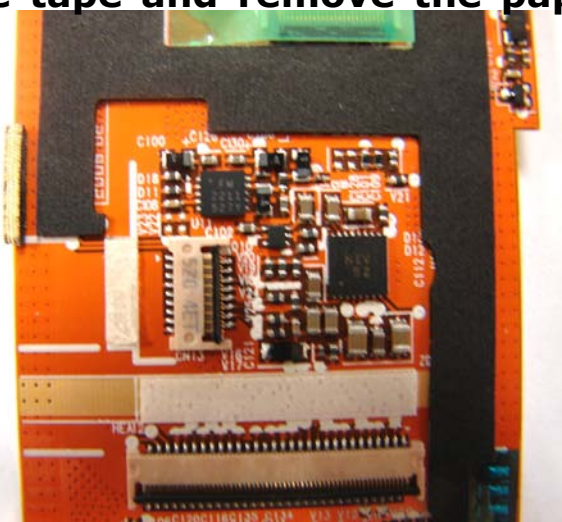

[connect navi key]

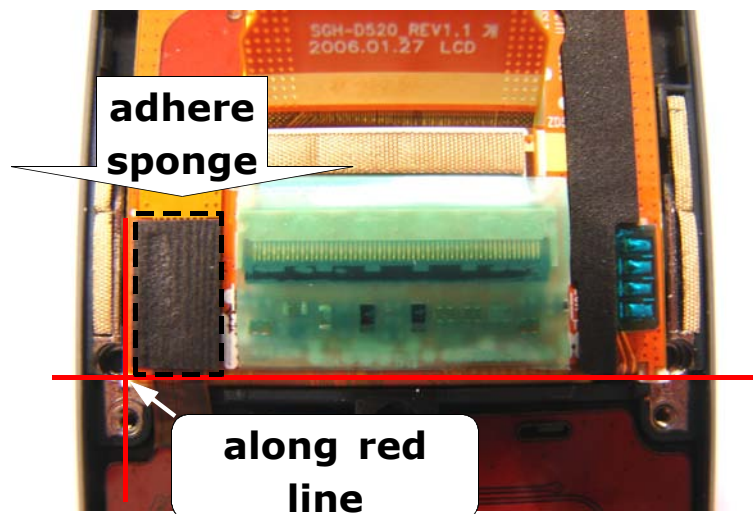
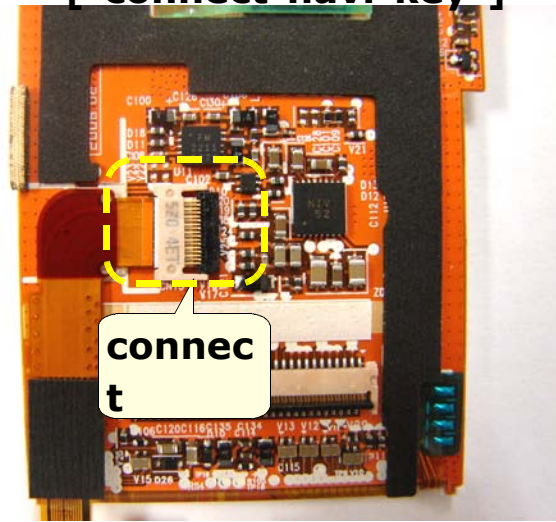

[Attach TAPE]

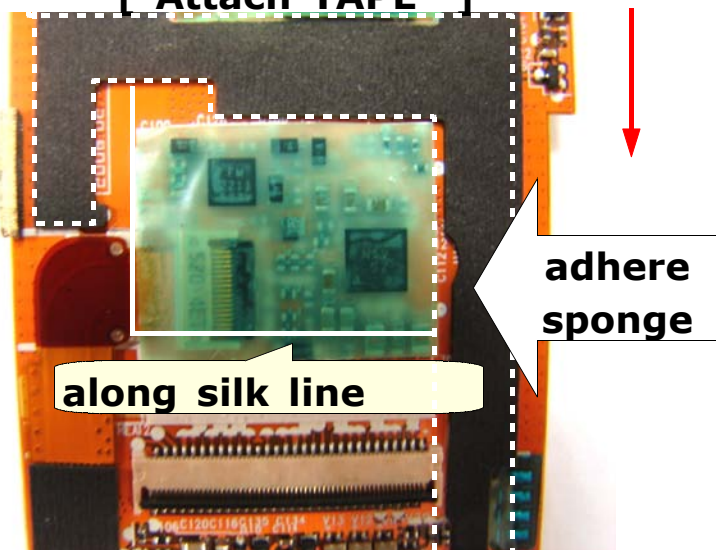

INSTRUMENTS TO BE USED				
NO	MATERIAL	CODE	STANDARD	Quan
1	Navi KEY_FPCB	GH59-02717A	DC15V,1mA	1
2	TAPE	GH74-21362A	7X2X0.35T	1
3	LCD SPONGE	GH74-21627A	31.5*48*0.55t	1
4	TAPE	GH74-21362A	7X2X0.35T	1
5	FPCB SPONGE	GH74-21366A	18.8X14.5X0.085T	1
6				

Application		SGH-D520/D528	
Subject		Work Description NO	
connection of navi key		3	

ED	date of revision	Revision contents
1		
2		
3		
4		

Subject	Work contents	Confirmation and inspection standard
Inspection	-Inspect the dust in MAIN WINDOW	-Handle by badness if you find dust
Insertion	-Insert LCD to UPPER CASE.	
Re-Inspection	-RE-inspect MAIN WINDOW after removing half part of tape	-Handle by badness if you find dust

[Insert LCD]

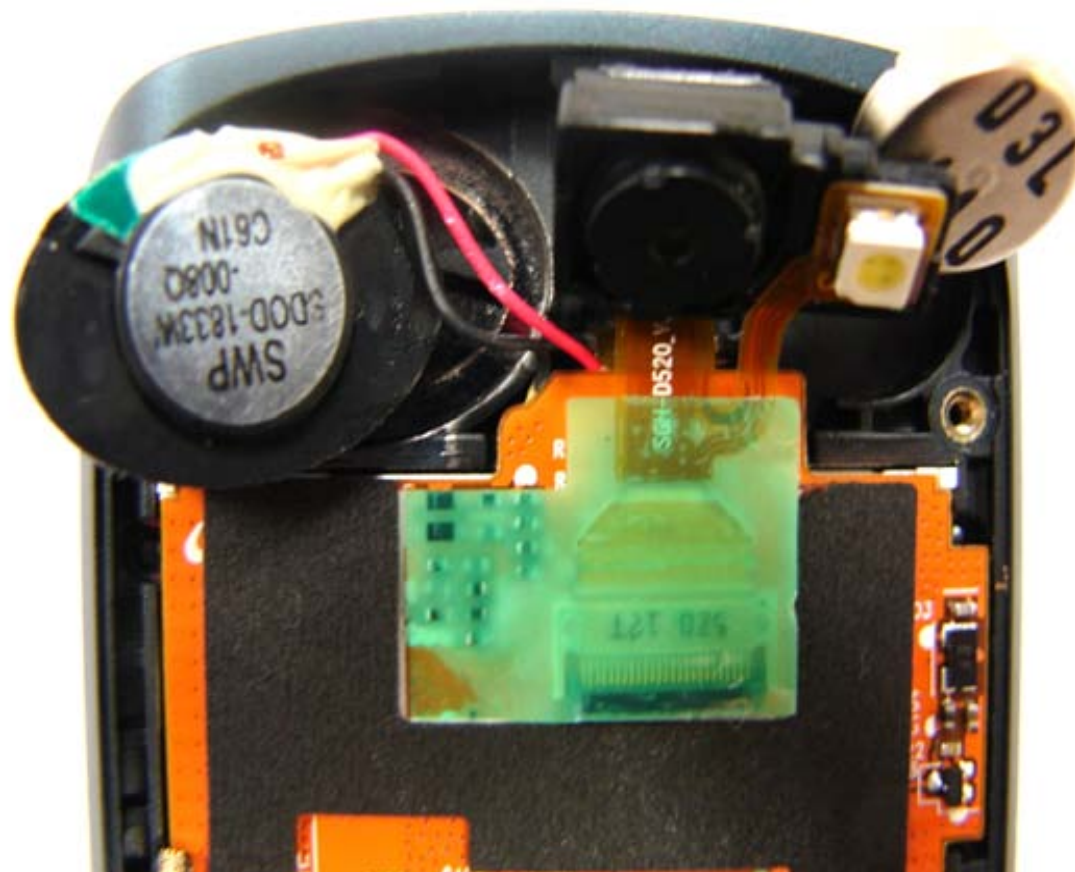

INSTRUMENTS TO BE USED				
NO	MATERIAL	CODE	STANDARD	Quantity
1	LCD	-	D520	1EA
2	CAMERA	-	D520	1EA
3	Air-gun	-	-	-
4	Tweezers	-	-	1EA
5				
6				
Application			SGH-D520/D528	
Subject				Work Description NO
Assembly UPPER CASE and LCD				4
ED	date of revision	Revision contents		
1				
2				
3				
4				

Subject	Work contents	Confirmation and inspection standard
Inspection	-Inspect the dust in MAIN WINDOW	-Handle by badness if you find dust
Insertion	-Insert motor to UPPER CASE	-Handle wires cautiously
Insertion	-Insert camera to UPPER CASE	-Handle camera FPCB crack
Insertion	-Insert speaker to UPPER CASE	-Handle wires cautiously

[Insertion state of LCD]

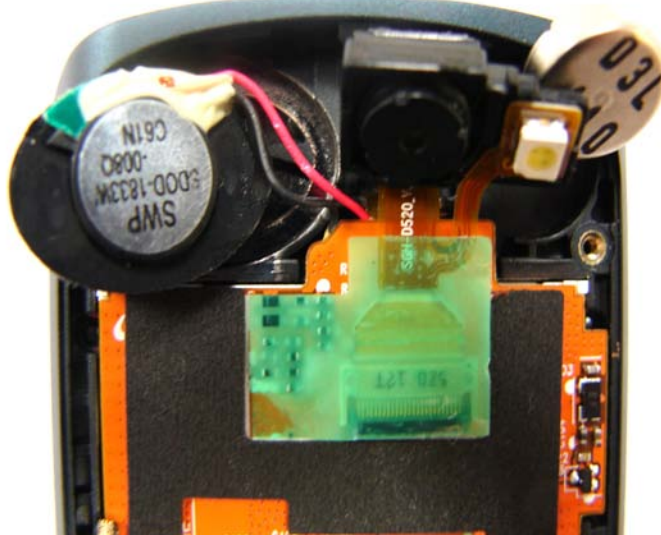

[insert motor]

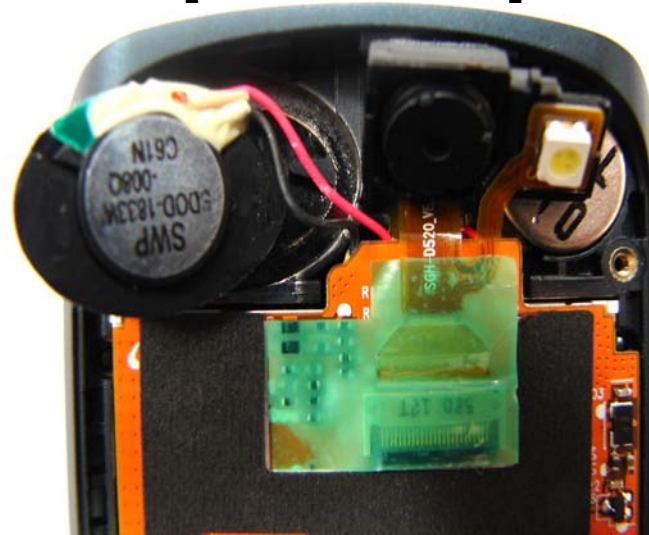

[insert speaker]

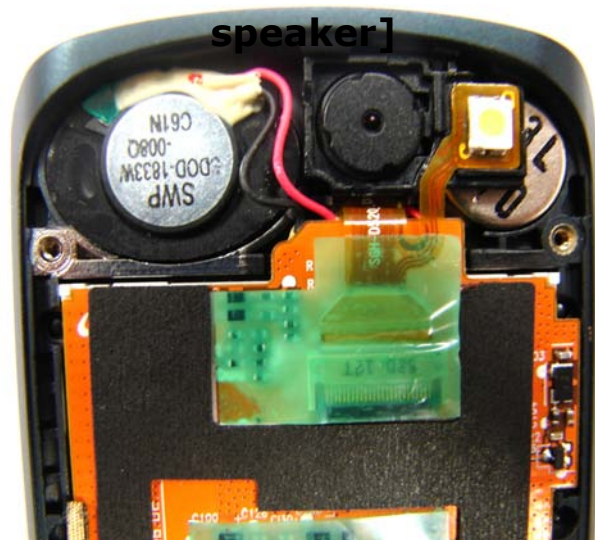

[insert camera]



INSTUMENTS TO BE USED

NO	MATERIAL	CODE	STANDRAD	Quan
1	Hand strap	-	-	1
2	Tweezers	-	-	1
3	Gloves	-	-	1
4				
5				
6				

Application

SGH-D520/D528

Subject

Work Description NO

Insertion of motor, camera and speaker

5

ED	Date of revision	Revision contents
1		
2		
3		
4		

Subject	Work contents	Confirmation and inspection standard
Inspection	-Inspect exterior of Unit	-scratch and printing badness
Insertion	-Insert Navi KEY to UPPER CASE	-Look at picture
Assembly	-Fix Navi KEY PBA along fixing lever	

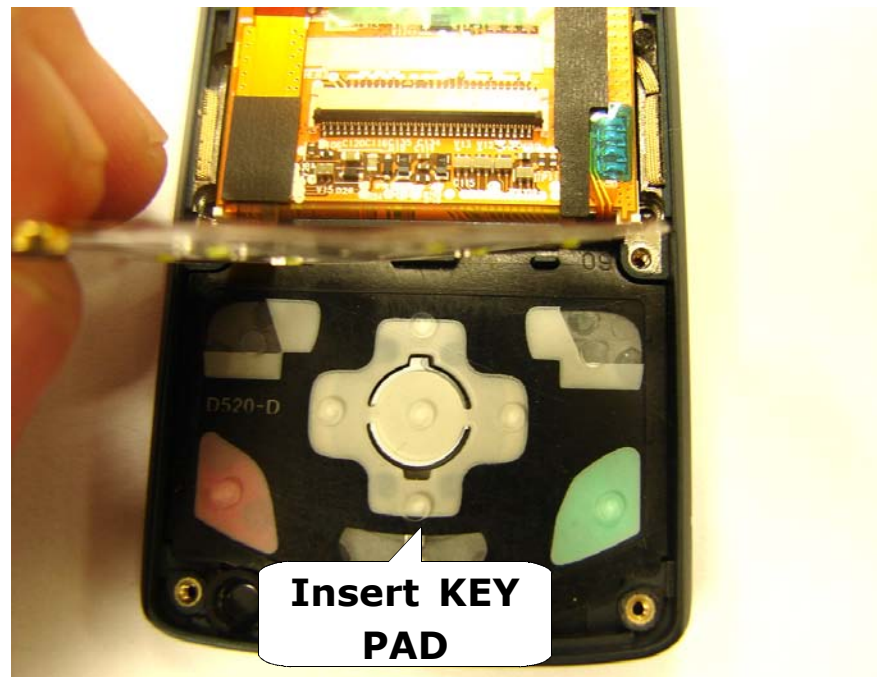

INSTUMENTS TO BE USED				
NO	MATERIAL	CODE	STANDRAD	Quan
1	NAVI KEY	GH75-08861A	D520	1
2				
3				
4				
5				
6				
Application			SGH-D520/D528	
Subject			Work Description NO	
Assembly of Navi KEY PAD			6	
ED	Date of revision	Revision contents		
1				
2				
3				
4				

Subject	Work contents	Confirmation and inspection standard
TAPE	-Adhere tape	
REMOVE	-Remove paper on tape that is attached to LCD	
Insertion of MAIN FPCB	-Insert FPCB and make connector and FPCB silk parallel	

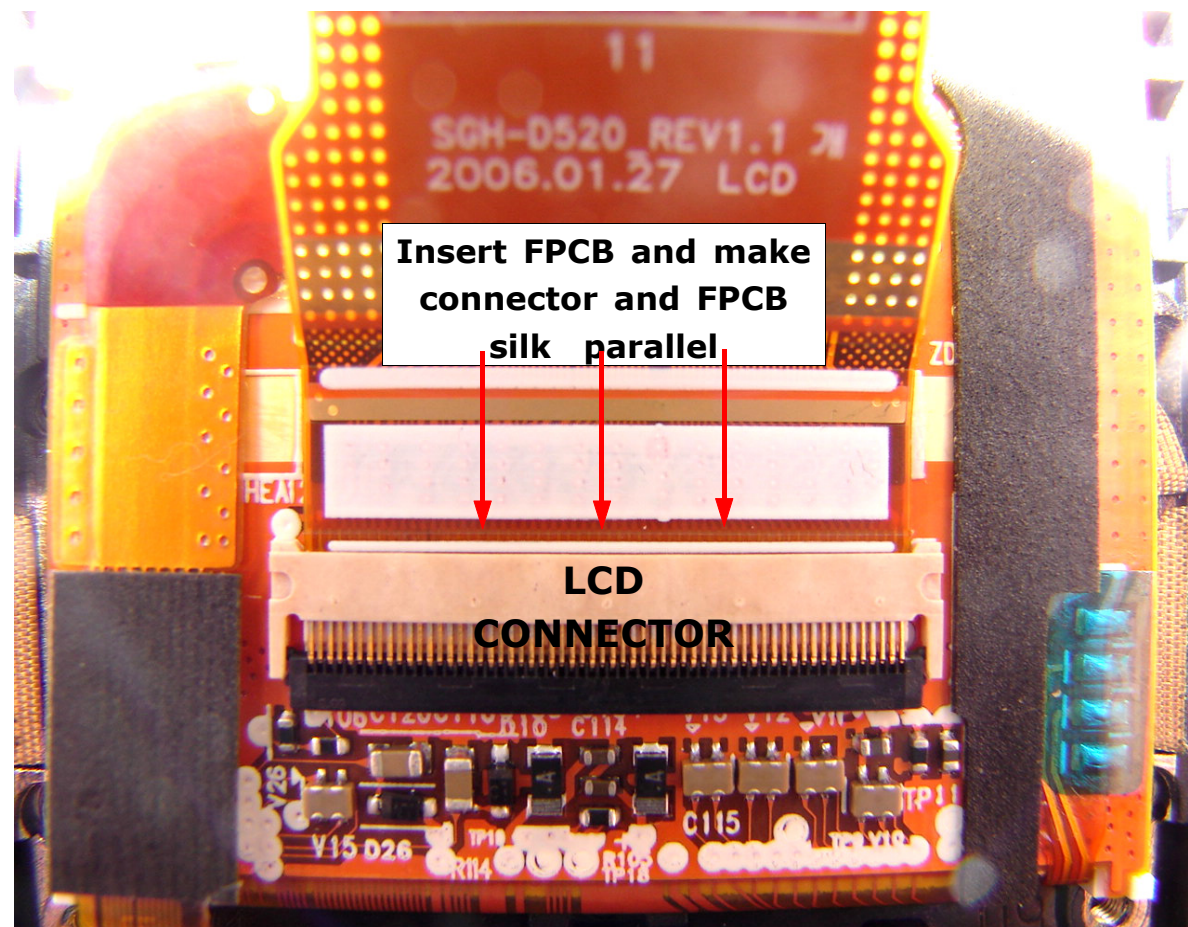

INSTUMENTS TO BE USED				
NO	MATERIAL	CODE	STANDRAD	Qua n
1	MAIN FPCB	GH41-01066A	18.33X61.0 0mm	1
2	TAPE	GH74-21365A	21X12.5X0. 085T	1
3				
4				
5				
6				
Application			SGH-D520/D528	
Subject			Work Description NO	
MAIN FPCB Connection			7	
ED	Date of revision	Revision contents		
1				
2				
3				
4				

Subject	Work contents	Confirmation and inspection standard
Adhere gold TAPE	-Adhere gold tape along white silk line	-Look at left picture
Adhere TAPE	-Adhere tape along white silk line	-Look at right picture

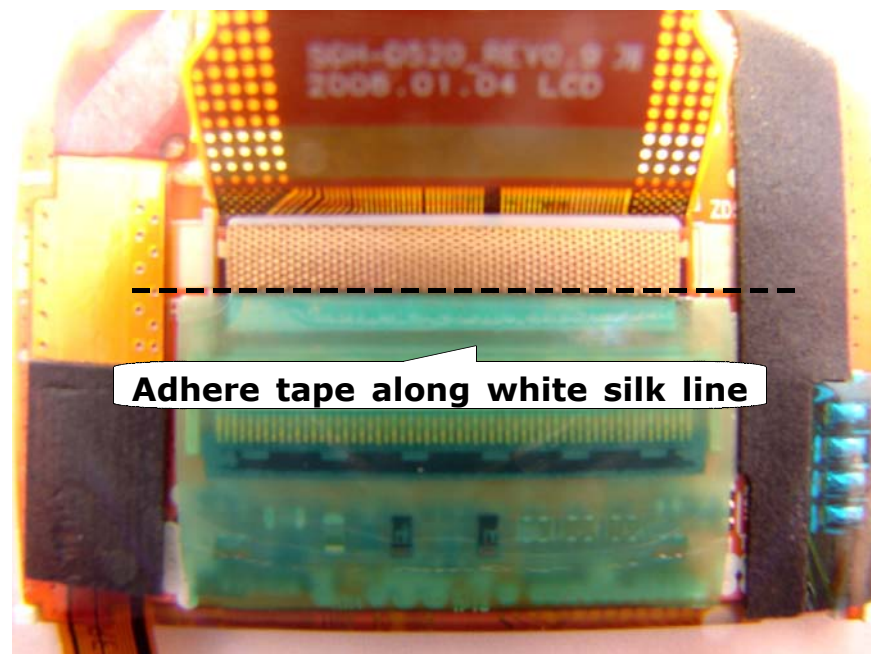
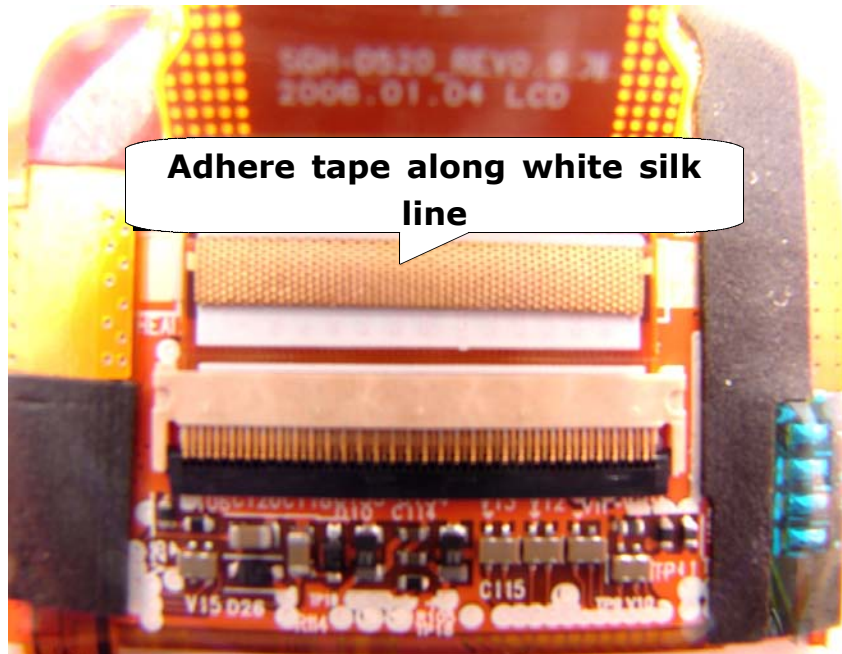

INSTUMENTS TO BE USED				
NO	MATERIAL	CODE	STANDRAD	Quan
1	TAPE	GH74-21369A	19X3X0.35T	1
2	LCD Gasket TAPE	GH74-21361A	17X2X0.3T	1
3				
4				
5				
6				

Application		SGH-D520/D528
Subject		Work Description NO
ADHERE TAPE		8

ED	Date of revision	Revision contents
1		
2		
3		
4		

Subject	Work contents	Confirmation and inspection standard
Inspection	- Inspect exterior of mic-holder	-confirm whether there is small hole(look at picture)
Insertion	- Insert mic-holder with mic	-look at picture

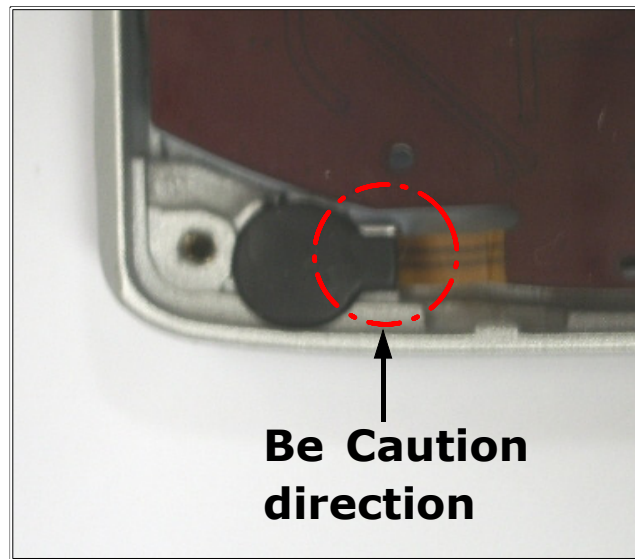
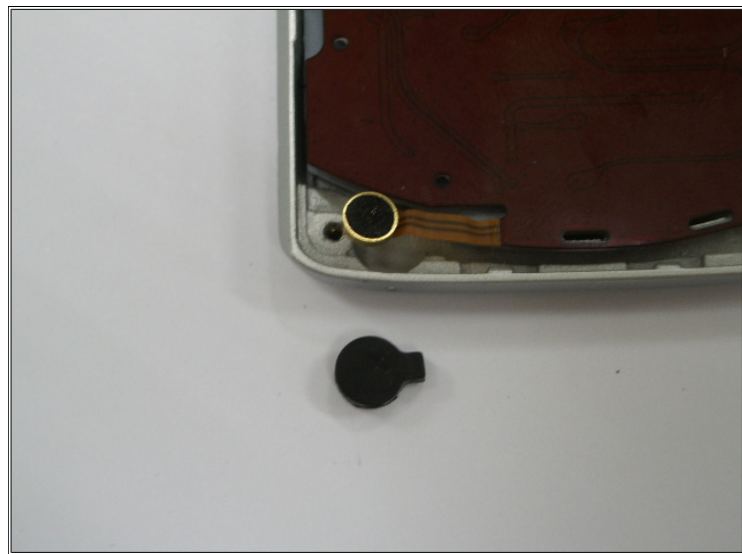

Confirm whether there is small hole under mic-holder(like left picture)



INSTUMENTS TO BE USED				
NO	MATERIAL	CODE	STANDRAD	Quan
1	MIC-HOLDER		D520	1EA
2	AIR-GUN	-	-	-
3	Tweezers	-	-	1EA
4				
5				
6				

Application		SGH-D520/D528	
Subject			Work Description NO
Insertion of mic-holder			9

ED	Date of revision	Revision contents
1		
2		
3		
4		

Subject	Work contents	Confirmation and inspection standard
Inspection	-Confirm tape specification attaching basically to LOWER CASE	-Look at right picture
Assembly of LOWER CASE	-Fold soldering part of FPCB(2 points) -Insert FPCB to LOWER CASE -First of all, assemble top portion of HOOK -Assemble lower portion of HOOK	-Look at pictures

[Assembly flowchart]

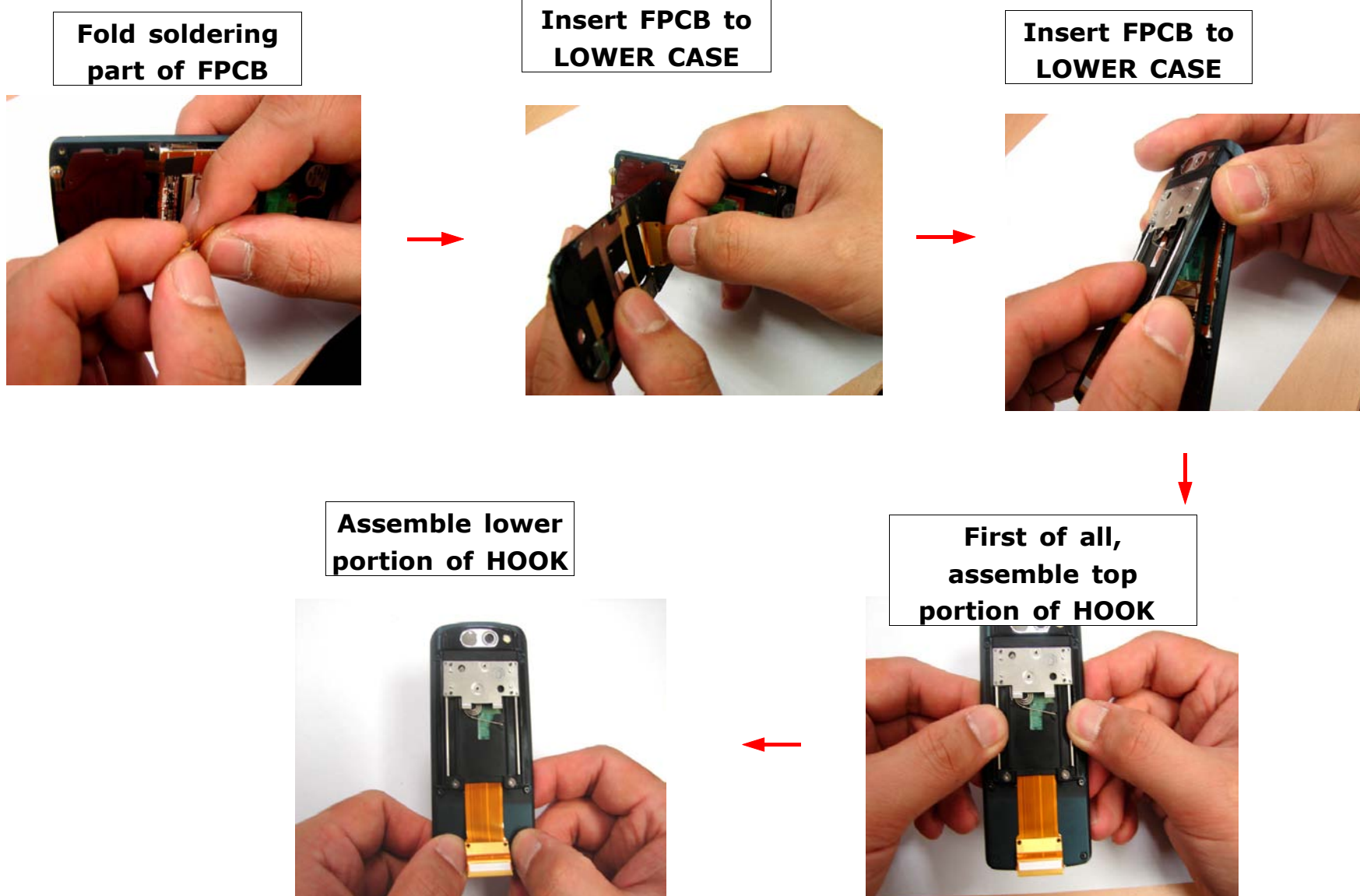

INSTUMENTS TO BE USED				
NO	MATERIAL	CODE	STANDRAD	Quan
1	LOWER CASE	GH75-08859A	D520	1
2				
3				
4				
5				
6				

Application		SGH-D520/D528
Subject		Work Description NO
LOWER CASE Assembly		10

ED	Date of revision	Revision contents
1		
2		
3		
4		

Warning

■ Torque of Electric motor when you assemble
LOWER CASE and UPPER CASE
 => SPEC : 1.1kgf/m±0.1

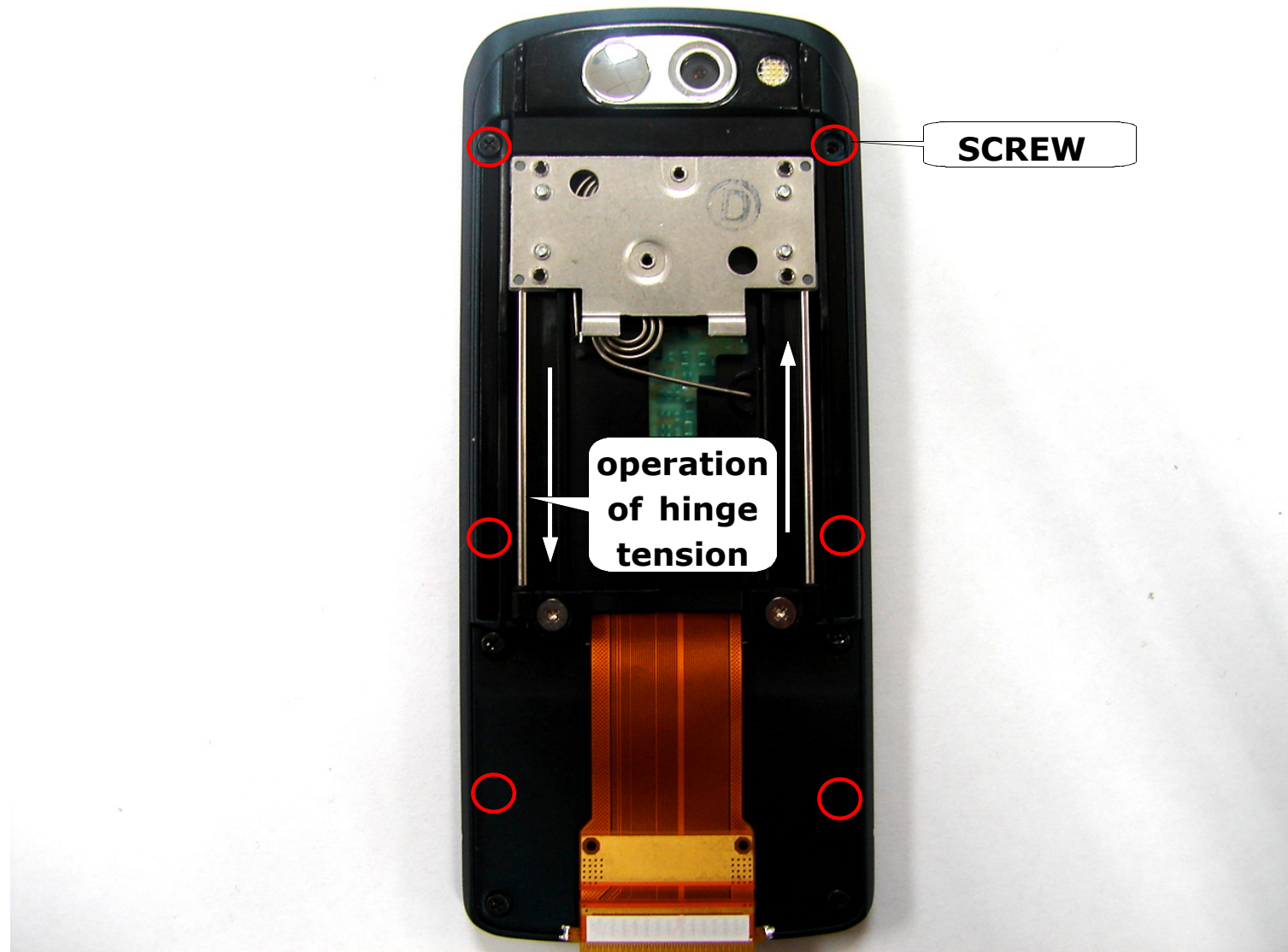

INSTUMENTS TO BE USED				
NO	MATERIAL	CODE	STANDRAD	Qu an
1	SCREW	6001-001530	M1.4,L2.5	1
2	Electric motor	-	-	1
3	JIG for assembly	-	-	1
4	Hand strap	-	-	1
5				
6				

Application		SGH-D520/D528
Subject		Work Description NO
SCREW		11

ED	Date of revision	Revision contents
1		
2		
3		
4		

Subject	Work contents	Confirmation and inspection standard	Warning				
Inspection	-Inspect exterior of Main Front	-Confirm damage -Confirm whether or not magnet work. -Handle by badness at bonding excess to magnet	■ If it produces only one time that is creased to FPCB, don't reuse				
Assembly of Main Front	-Assemble Main Front and hole of slide hinge	-Confirm whether LCD and Main Front are twisted or not after assembly					

INSTUMENTS TO BE USED				
NO	MATERIAL	CODE	STANDRAD	Quan
1	FRONT	GH75-08863A	D520	1
2				
3				
4				
5				
6				

Application		SGH-D520/D528	
Subject			Work Description NO
Assembly and inspection of Main Front			12

(ED)	Date of revision	Revision contents
1		
2		
3		
4		

Subject	Work contents	Confirmation and inspection standard
SCREW	-Check the screw size -Place Front on JIG -Screw	

Warning

■ Torque of Electric motor when you assemble
LOWER CASE and UPPER CASE
=> SPEC : 0.9kgf/m ~ 1.1kgf/m

[SCREW]

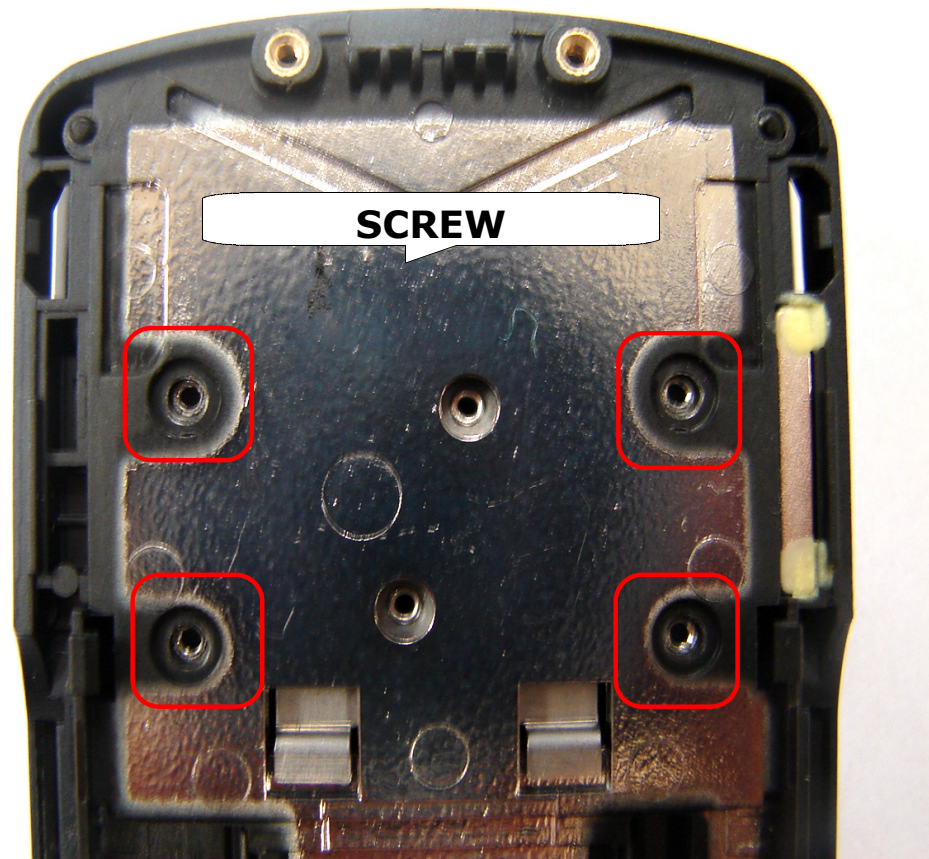

INSTUMENTS TO BE USED				
NO	MATERIAL	CODE	STANDRAD	Quan
1	SCREW	6001-001700	M1.4,L2	1
2	Electric motor	-	-	1
3	JIG for screw	-	-	1
4				
5				
6				

Application		SGH-D520/D528	
Subject			Work Description NO
Front SCREW			13

ED	Date of revision	Revision contents
1		
2		
3		
4		

Subject	Work contents	Confirmation and inspection standard
Adhere black tape	-Atach black tape via red dotted line like picture.	

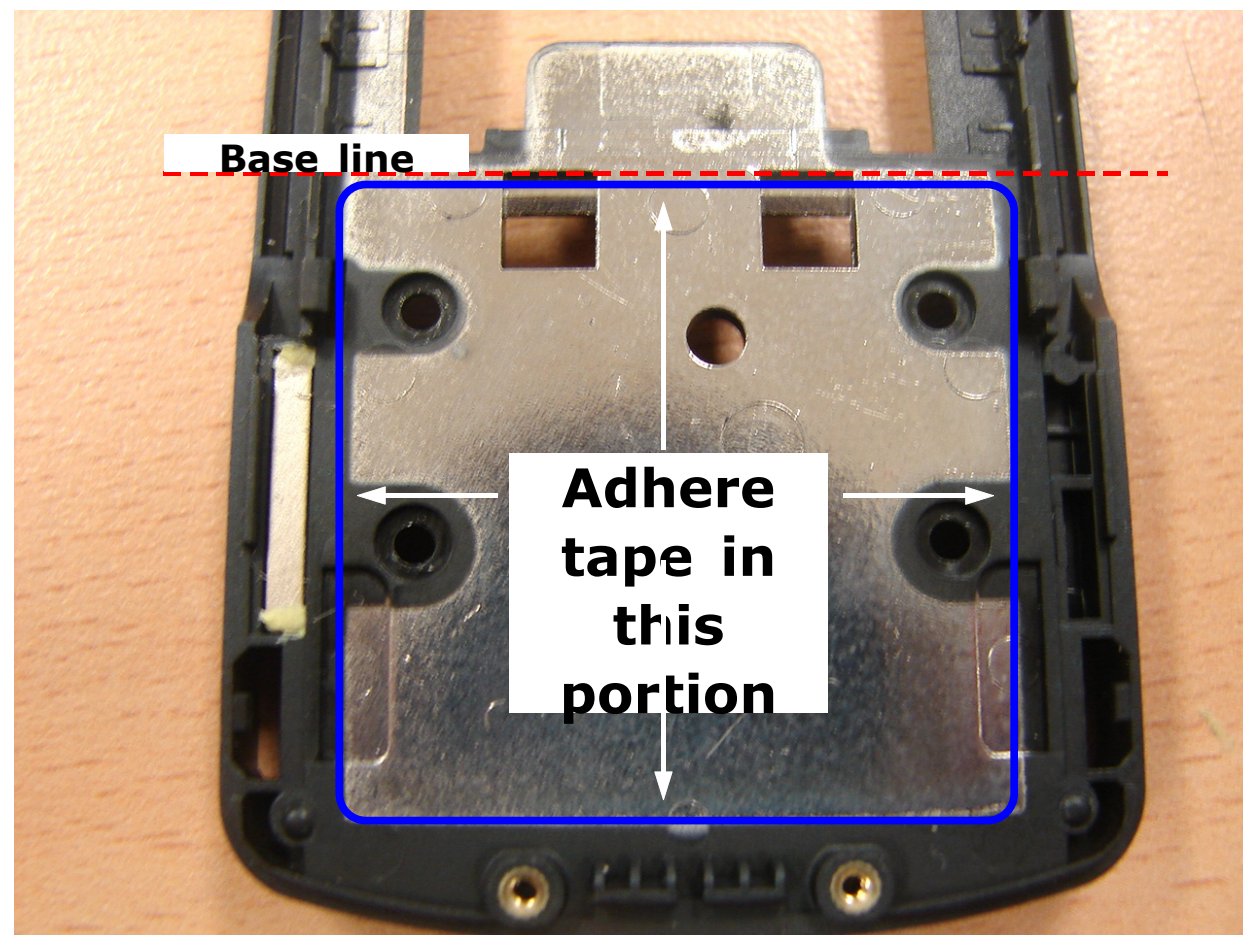

INSTUMENTS TO BE USED				
NO	MATERIAL	CODE	STANDRAD	Quan
1	TAPE	GH74-23218A	32.6x34.35 x0.1,bk	1
2				
3				
4				
5				
6				
Application			SGH-D520/D528	
Subject			Work Description NO	
Adhere tape			14	
ED	Date of revision	Revision contents		
1				
2				
3				
4				

Subject	Work contents	Confirmation and inspection standard
Adhere	-Adhere MAIN FPCB Gasket TAPE in appointment position	-Adhere FPCB TAPE FPCB In top portion of FPCB silk

[Goodness]

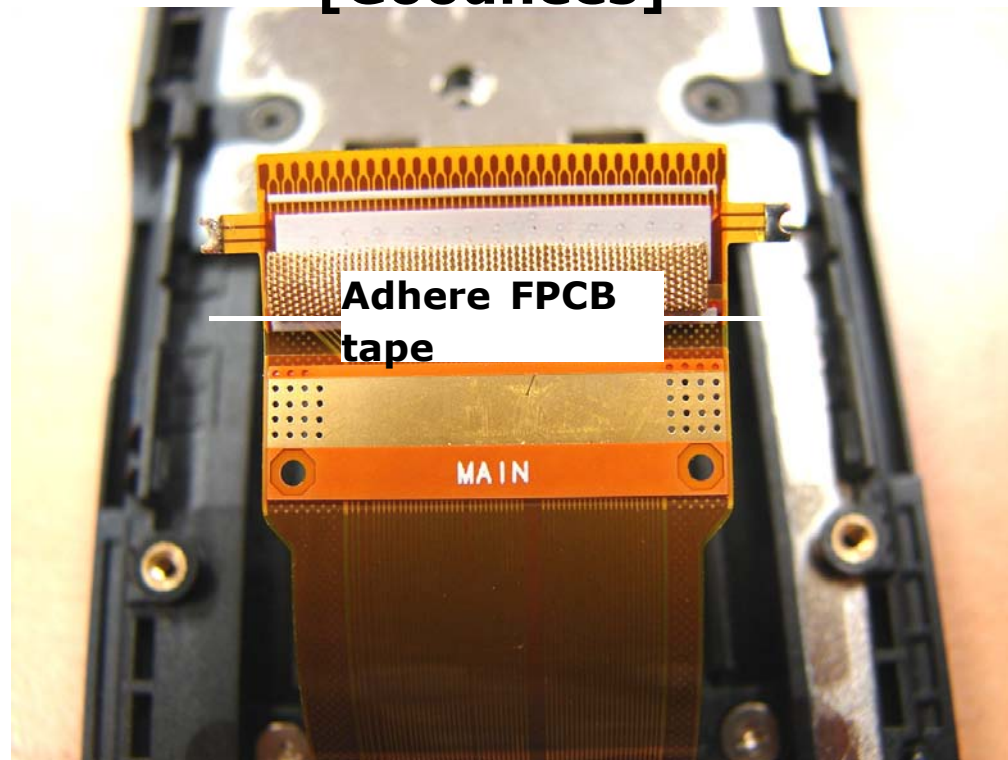

[Badness]

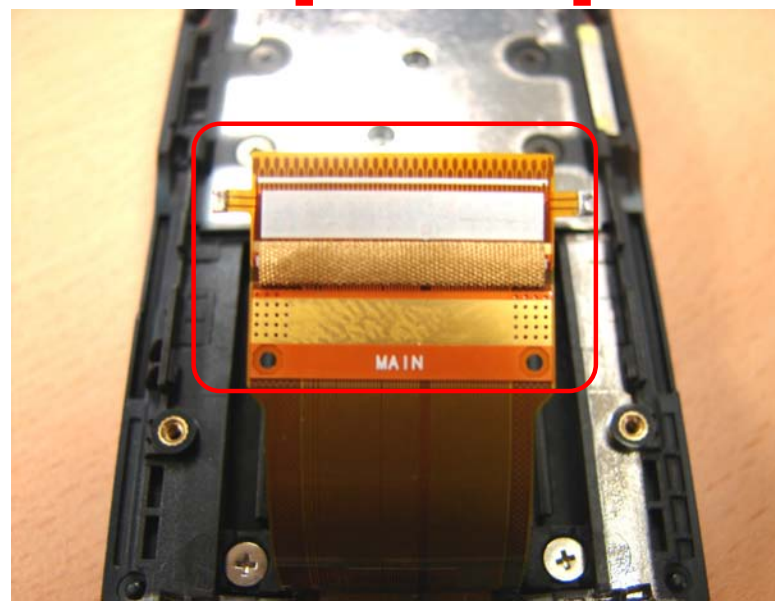

Subject	Work contents	Confirmation and inspection standard
Inspection	-Inspect camera KEY FPCB	-Damaged camera FPCB PAD/torn FPCB => Badnees
Inspection	-Inspect soldering parts of camera key in board	-Damaged camera KEY PAD, Separated PAD, Short => Badness
Soldering	-Solder camera KEY FPCB on board	-Solder between Guide Holes -Don't happen short

Warning

- Take care so that CHIP and SHORT may not happen after soldering of camera KEY FPCB
- Temperature of Soldering iron : 350°~380°
- Do to drop power after use of soldering iron complete

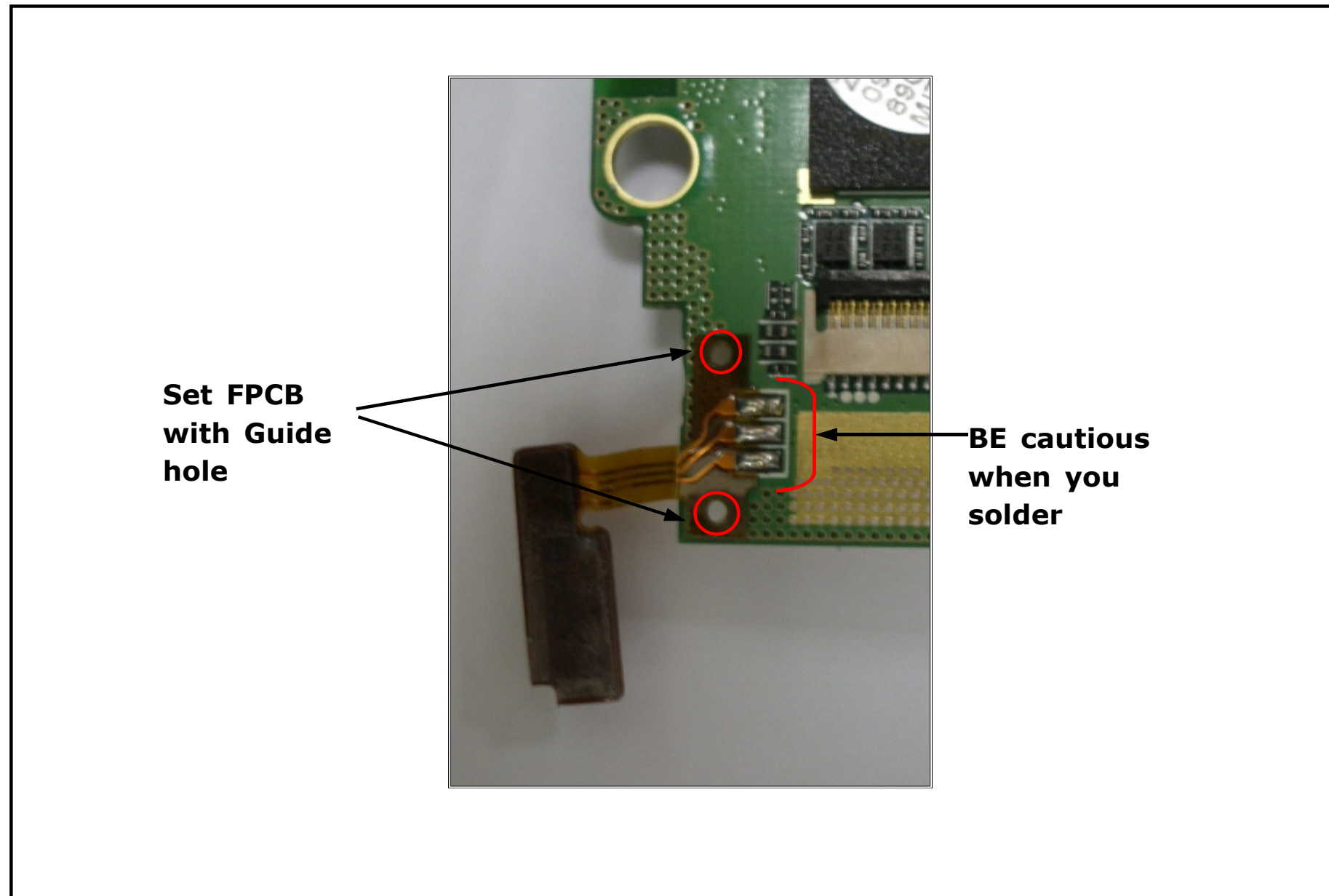

INSTUMENTS TO BE USED				
NO	MATERIAL	CODE	STANDRAD	Qua n
1	Camera Key FPCB	-	D520	1EA
2	JIG for soldering of Camera Key	-	D520	1EA
3	Soldering iron	-	350°~380°	1EA
4	Lead	-	SR-34 (PA TYPE)	1EA
5	Hand-strap	-	-	1EA

Application		SGH-D520/D528	
Subject			Work Description NO
Soldering of camera KEY FPCB			16

ED	Date of revision	Revision contents
1		
2		
3		
4		

Subject	Work contents	Confirmation and inspection standard
Inspection	-Inspect SIDE KEY FPCB	-Damaged SIDE FPCB PAD/torn FPCB => Badness
Inspection	-Inspect soldering parts of side key in board	-Damaged SIDE KEY PAD, Separated PAD, Short => Badness
Soldering	Solder SIDE KEY FPCB on board	-Solder between Guide Holes -Don't happen short

Warning

■ Temperature of Soldering iron : 350°~380°

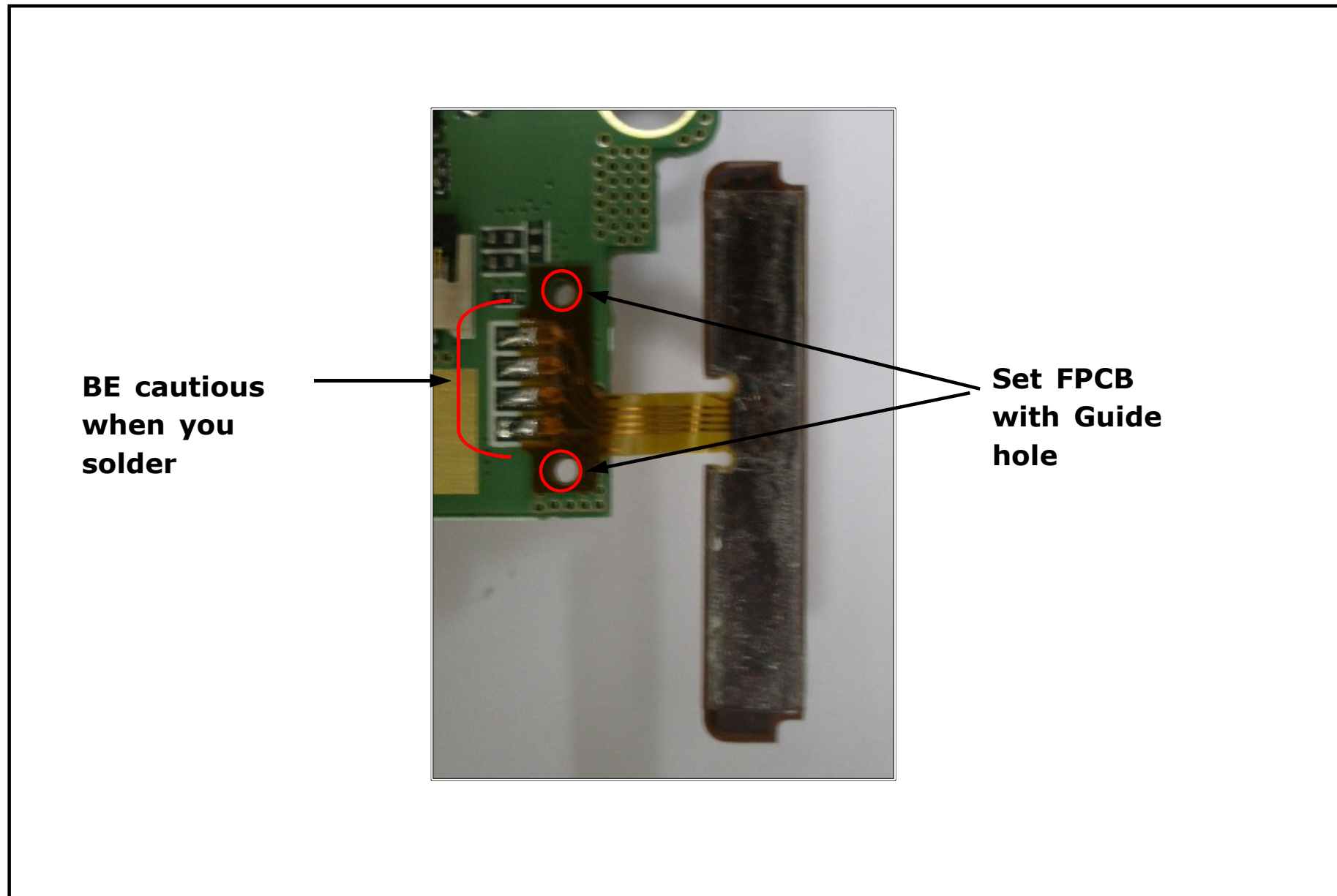

INSTUMENTS TO BE USED				
NO	MATERIAL	CODE	STANDRAD	Quan
1	SIDE KEY FPCB	-	D520	1EA
2	JIG for soldering of Side Key	-	D520	1EA
3	Soldering iron	-	350°~380°	1EA
4	Lead	-	SR-34 (PA TYPE)	1EA
5	Air	-	-	-
6	Hand-strap	-	-	1EA
7	Gloves	-	-	1EA

Application	SGH-D520/D528
Subject	Work Description NO
Soldering of SIDE KEY FPCB	17

(ED)	Date of revision	Revision contents
1		
2		
3		
4		

Subject	Work contents	Confirmation and inspection standard
Inspection	Inspect exterior of antenna	Check Flexure of Metal plate ,Damage and Dust
Soldering	-Place board and antenna on JIG -Solder antenna	

Warning

■ Temperature of Soldering iron : 350°~380°

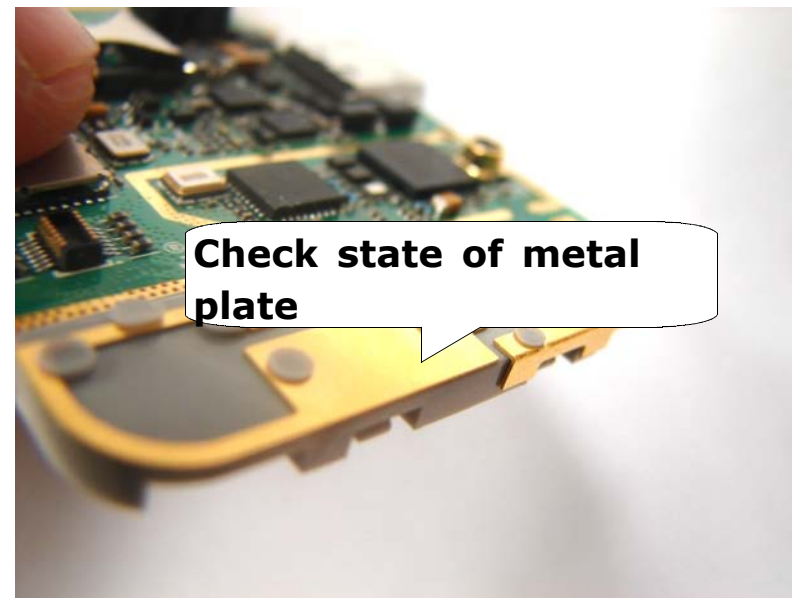

INSTUMENTS TO BE USED				
NO	MATERIAL	CODE	STANDRAD	Quan
1	Antenna	-	이터트로닉스	1EA
2	Soldering iron	-	350°~380°	1EA
3	Lead	-	SR-34 (PA TYPE)	1EA
4	Air	-	-	-
5	Hand-strap	-	-	1EA
6	Gloves	-	-	1EA
7				

Application		SGH-D520/D528	
Subject			Work Description NO
Soldering of antenna			18

ED	Date of revision	Revision contents
1		
2		
3		
4		

Subject	Work contents	Confirmation and inspection standard
Inspection	-Inspect the exterior of SHIELD CAN(Metal)	-Check whether there is part that come out bounding on inside. -There is part that come out bounding(Occurrence of Short) =>Badness -Silver part of WALL part has bounded to side and come out =>Badness badness

Warning

■ Torque : Torque : $1 \pm 0.1 \text{ Kgf/cm}^2$

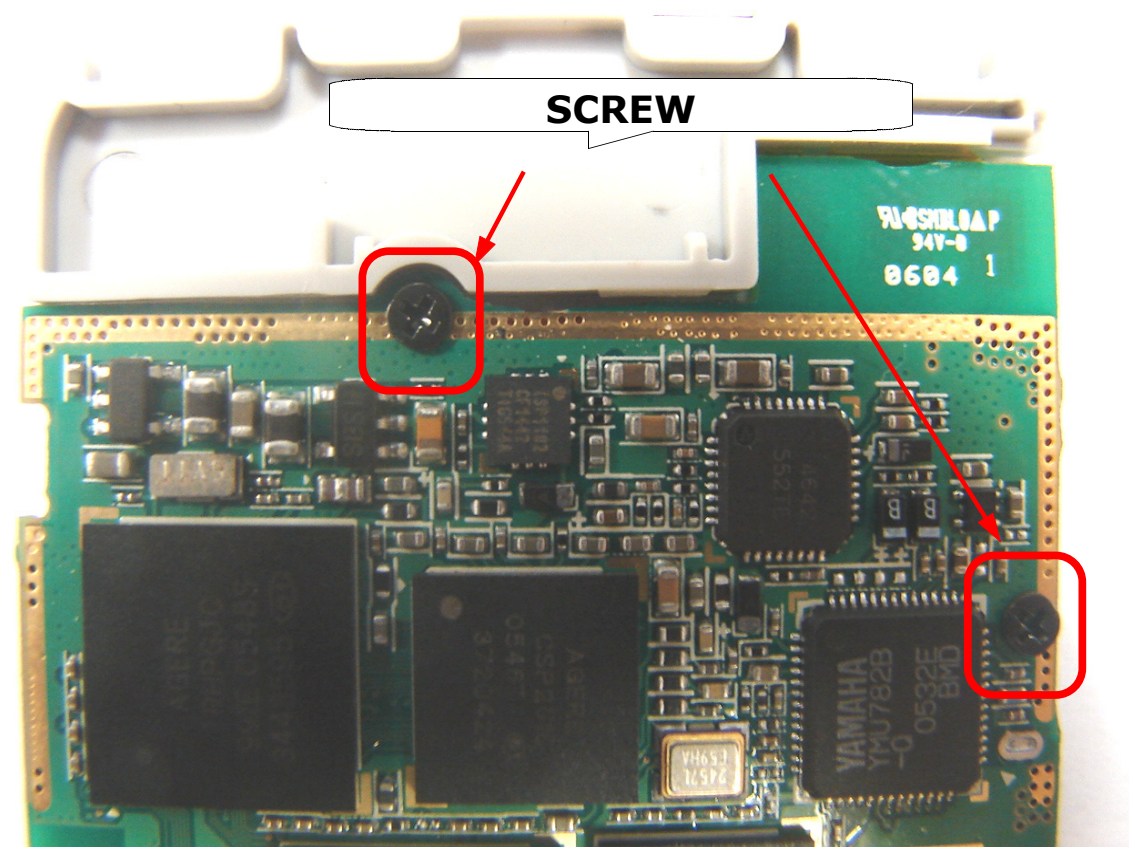

INSTUMENTS TO BE USED				
NO	MATERIAL	CODE	STANDRAD	Quan
1	Gloves	-	-	1EA
2	Hand-strap	-	-	1EA
3	+ screwdriver	-	-	1EA
4	screw	6001-001478	M1.4 * L3	2EA
5	JIG for screw	-	-	1EA
Application			SGH-D520/D528	
Subject			Work Description NO	
RF Shied CAN Assembly			S19	
ED	Date of revision	Revision contents		
1				
2				
3				
4				

Subject	Work contents	Confirmation and inspection standard
Adhere	-Use alcohol to remove a stitch of tape -Adhere tape	-Adhere TAPE along base line. -when you adhere tape, don't contact soldering of Key PAD

Warning

- Take care so that SHORT may not happen with slide connector pin when you adhere tape
- Check whether there is a stitch or not after adhering tape

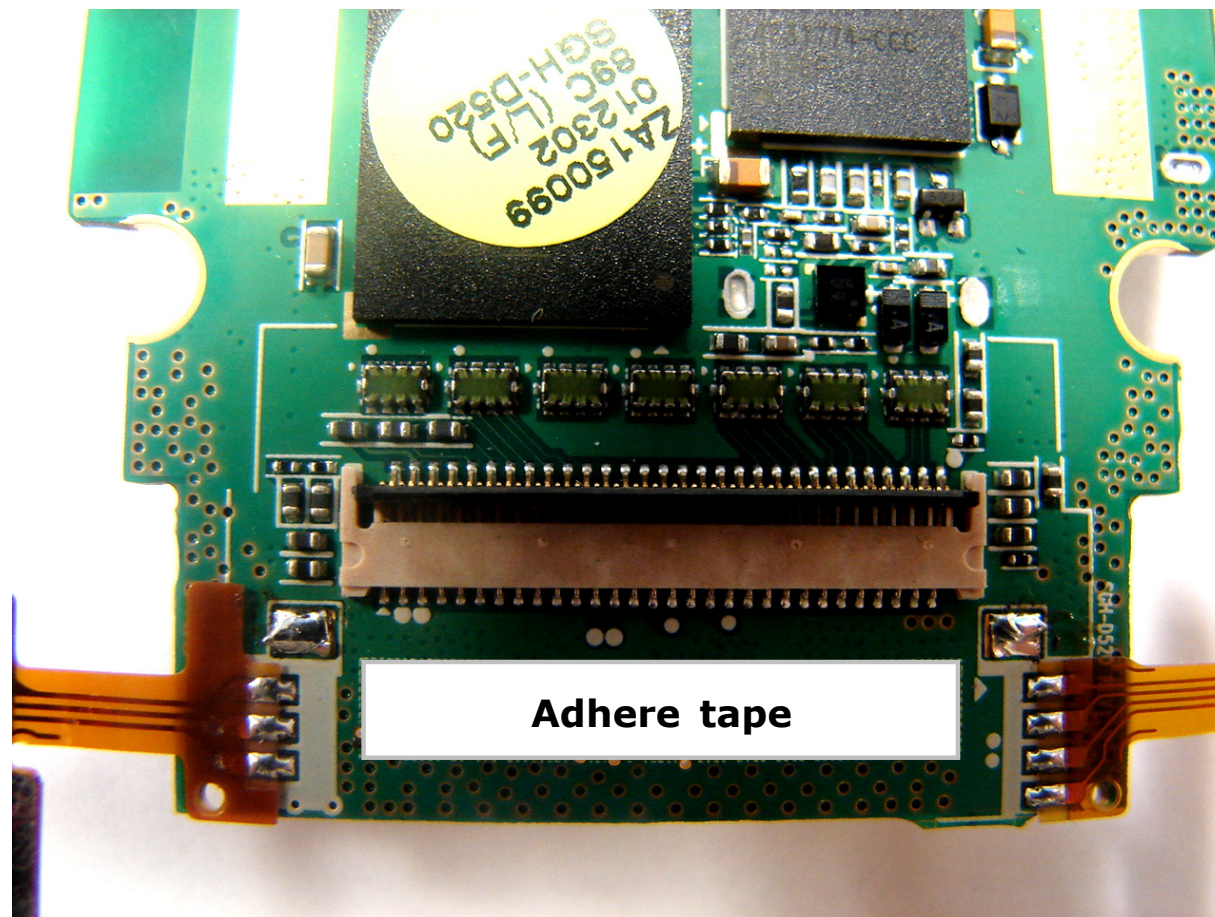

INSTUMENTS TO BE USED				
NO	MATERIAL	CODE	STANDRAD	Quan
1	Tape	GH74-21367A	19×4.5×0.3t	1EA
2	Hand-strap	-	-	1EA
3	Gloves	-	-	1EA
4	Tweezers	-	-	1EA
5				
6				
Application			SGH-D520/D528	
Subject			Work Description NO	
Adhere tape			20	
ED	Date of revision	Revision contents		
1				
2				
3				
4				

Subject	Work contents	Confirmation and inspection standard
Glue	-Glue on upper side of Bluetooth antenna	-Glue avoids that invade to SIM SOKET. -Glue avoids that is spread end of PBA
Confirmation	-Confirm whether glue invaded in SIM SOKET	-Blue invaded to SIM SOKEY => Badness (You can't assemble MAIN SET and it does not become SIM CARD realization)

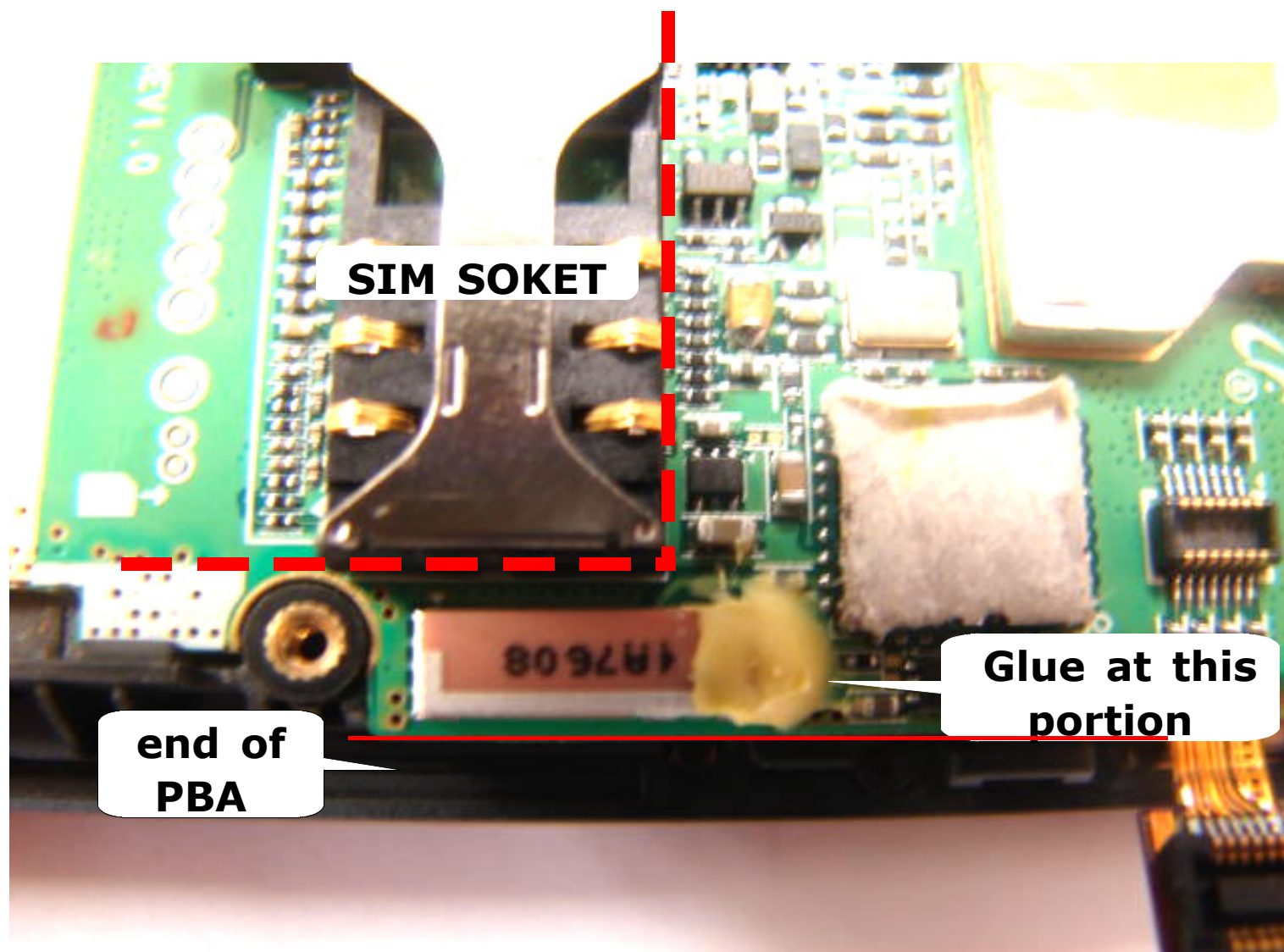

INSTUMENTS TO BE USED				
NO	MATERIAL	CODE	STANDRAD	Quan
1	Hand-strap	-	-	1EA
2	Gloves	-	-	1EA
3	Glue	-	-	1EA
4	Glue bulk	-	-	1EA
5				
6				

Application		SGH-D520/D528
Subject		Work Description NO
Glue		21

ED	Date of revision	Revision contents
1		
2		
3		
4		

Subject	Work contents	Confirmation and inspection standard
Adhere	-Adhere black TAPE in rihgt position like picture	-Adhere via end of PBA (Red dotted line)
SIM CARD Sticker	-Adhere SIM CARD insertion direction sticker like picture	

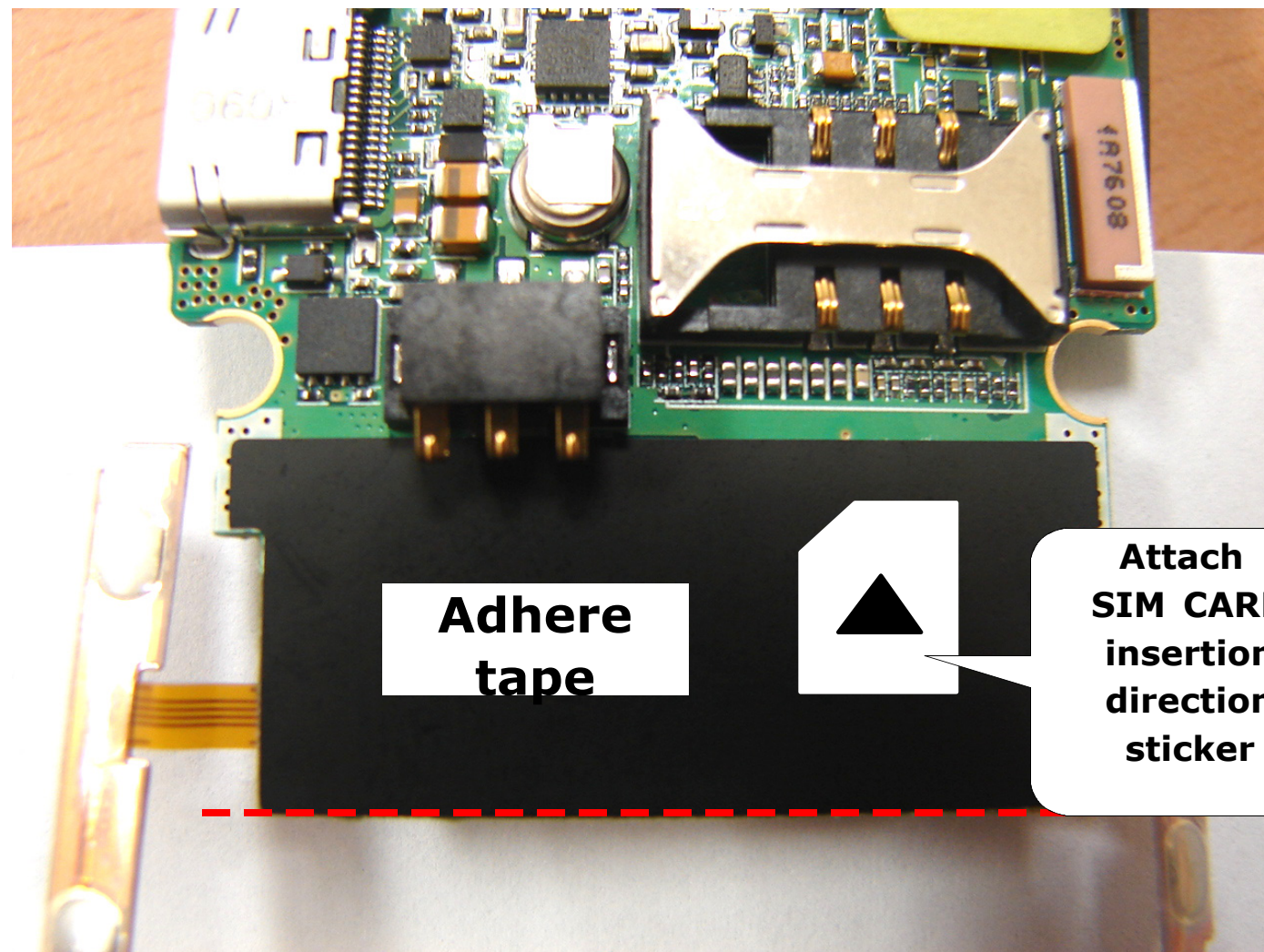

INSTUMENTS TO BE USED				
NO	MATERIAL	CODE	STANDRAD	Quan
1	TAPE	GH74-23217A	33.85x14.3x0.1,bk	1
2	SIM CARD Sticker	GH68-01920A	-	1
3				
4				
5				
6				
Application			SGH-D520/D528	
Subject			Work Description NO	
Adhere tape			22	
ED	Date of revision	Revision contents		
1				
2				
3				
4				

Subject	Work contents	Confirmation and inspection standard
Soldering	<ul style="list-style-type: none"> -Place JIG on JIG -Remove paper on tape -Connect FPCB to board connector. -Press down once after connection of FPCB and tape -Solder FPCB both soldering PAD with board 	<ul style="list-style-type: none"> -When solder, that take care so that surroundings CHIP and SHORT may not happen -Check state of PAD after FPCB soldering
PN Label	-Attach PN label attaching for board to MAIN WINDOW	

Warning

■When solder, that take care so that surroundings CHIP and SHORT may not happen

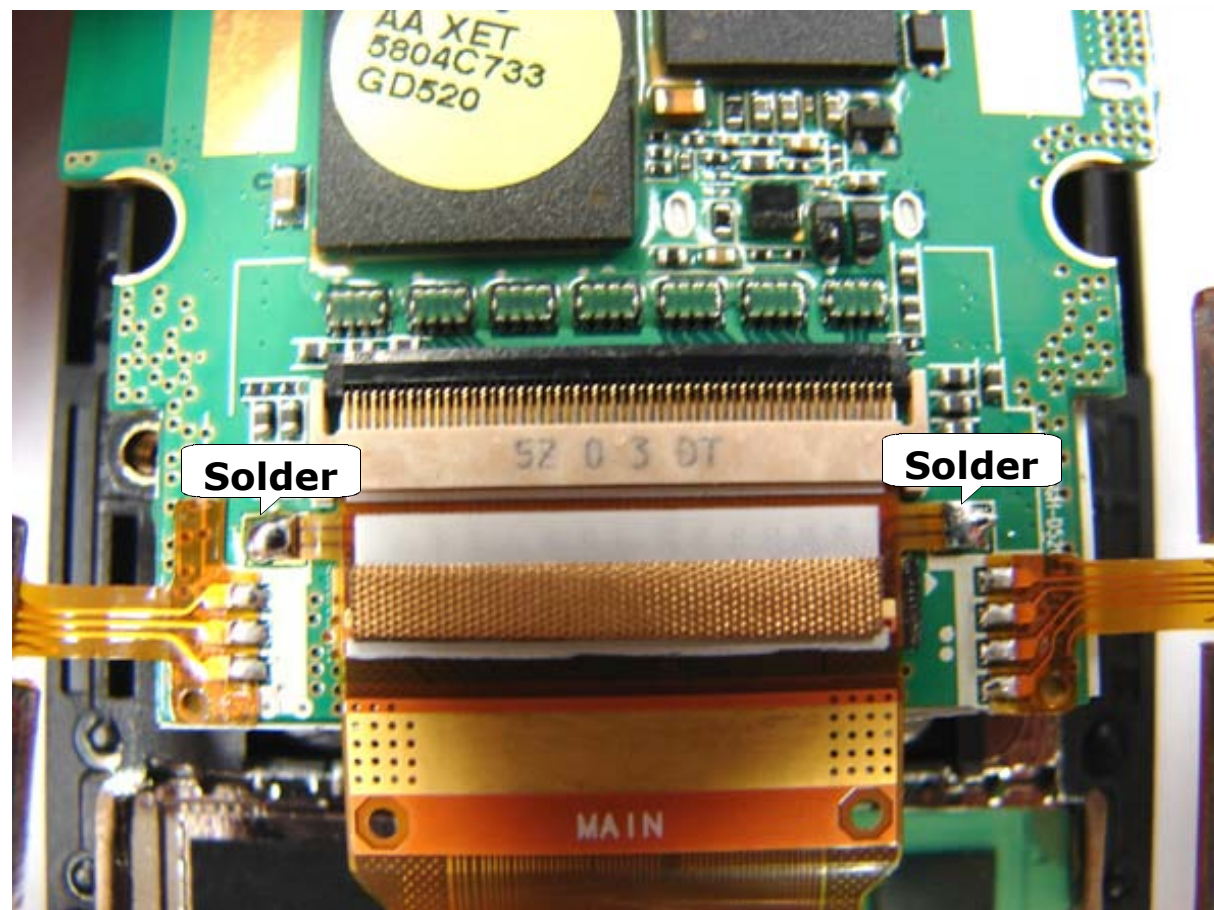

INSTUMENTS TO BE USED				
NO	MATERIAL	CODE	STANDRAD	Quan
1	Soldering iron	-	350°~380°	1EA
2	Lead	-	SR-34 (PA TYPE)	1EA
3	JIG for soldering	-	D520/D528	1CH
4				
5				
6				
Application			SGH-D520/D528	
Subject			Work Description NO	
Connct and Solder MAIN FPCB			23	
ED	Date of revision	Revision contents		
1				
2				
3				

Subject	Work contents	Confirmation and inspection standard
Adhere	-Adhere tape	-Adhere via TAPE sticking.
Confirmation	-Confirm state of FPCB TAPE	- Confirm whether attached via silk. =>Badness of slide connection happen if do not attach via silk

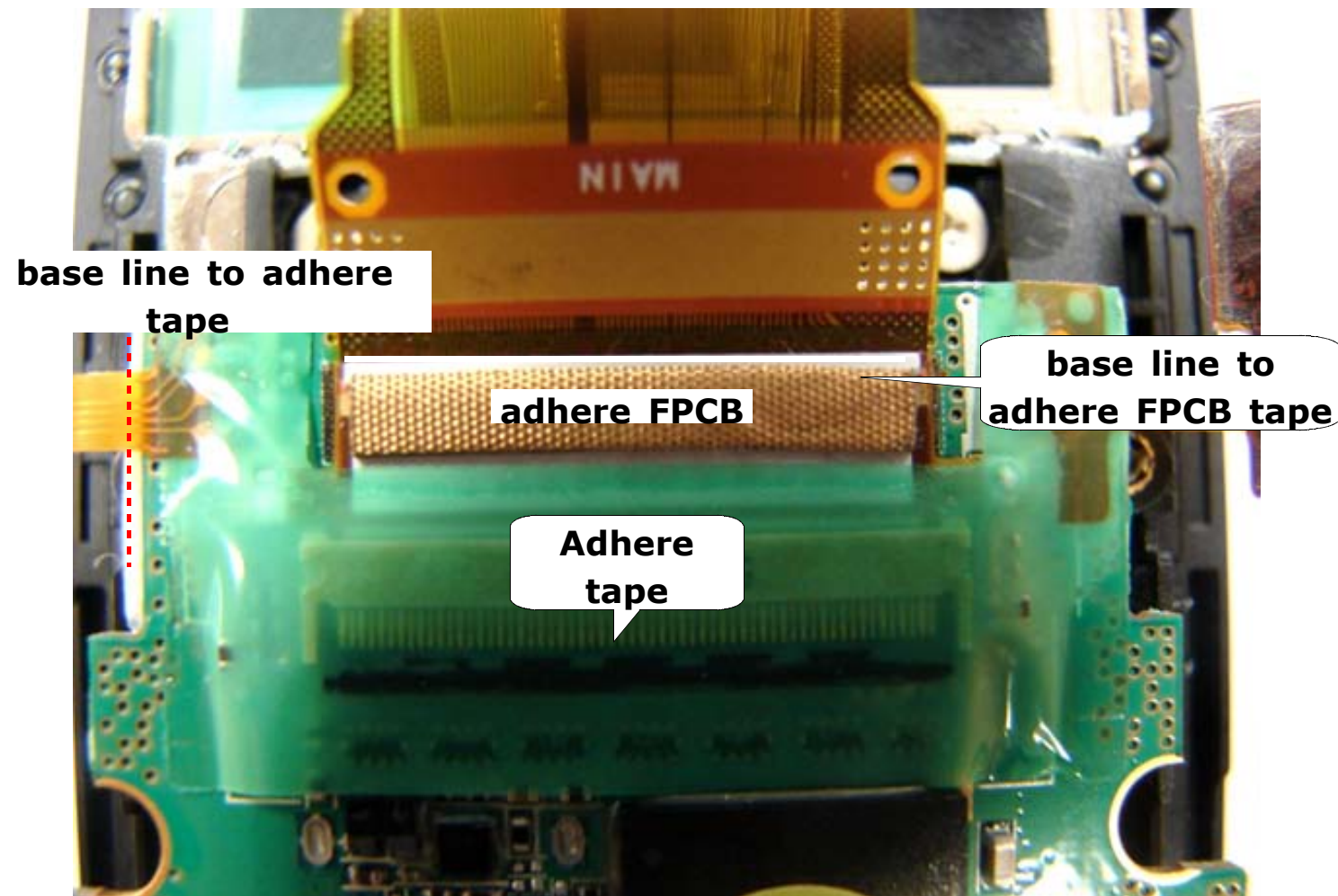

INSTUMENTS TO BE USED				
NO	MATERIAL	CODE	STANDRAD	Quan
1	TAPE	GH74-21368A	30X15.5X0.085T	1장
2	JIG for soldering	-	D520/D528	1대
3				
4				
5				
6				
Application			SGH-D520/D528	
Subject			Work Description NO	
Adhere tape			24	
ED	Date of revision	Revision contents		
1				
2				
3				

Subject	Work contents	Confirmation and inspection standard
Board	-Place board on Front	
Assembly	-Assembles from antenna and assembles the top portion	-Be cautious occurrence of loose antenna
Confirmation	-Confirm state of antenna and HOOK	-Be cautious occurrence of loose antenna
Assembly	-Assemble SET lower portion	
Connect	-Connect MAIN KEY connector to board	
Insertion	-Insert camera KEY in Front.	
Insertion	-Insert Side KEY in Front.	

Warning

■ Confirm the direction when you assemble SIDE KEY, camera KEY => if you consider the direction, badness happen.

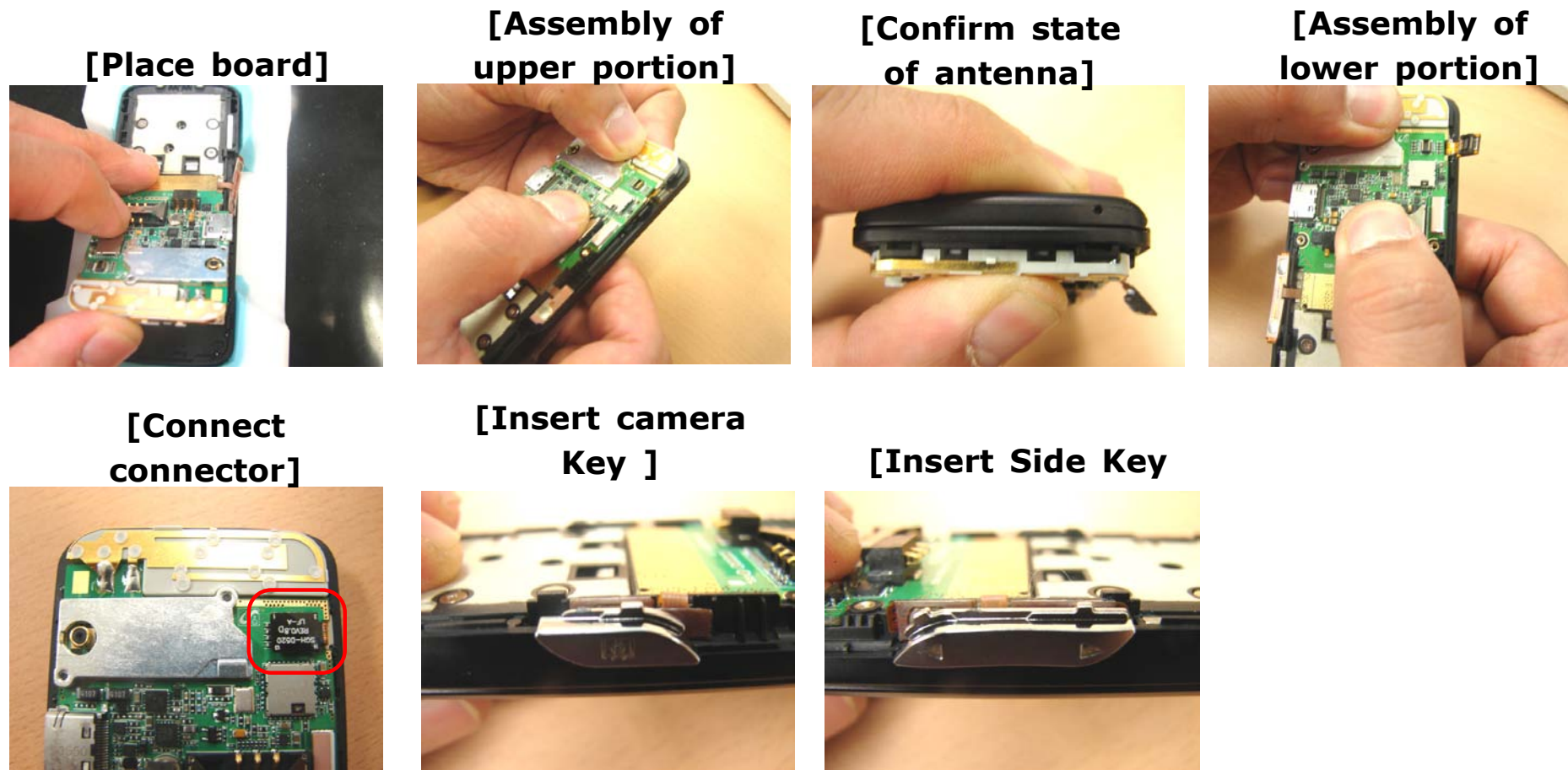

INSTUMENTS TO BE USED				
NO	MATERIAL	CODE	STANDRAD	Quan
1	Camera KEY	GH75-08866A	D520/D528	1EA
2	Side KEY	GH75-08277A	D520/D528	1EA
3				
4				
5				
6				
7				
Application			SGH-D520/D528	
Subject			Work Description NO	
Assembly of Camera key and Side key			25	
ⓔ	Date of revision	Revision contents		
1				
2				
3				
4				

Subject	Work contents	Confirmation and inspection standard
Assembly	-Assemble top portion of the MAIN SET	-Confirm GAP and White screen after assembly
Assembly	-Assemble right side of MAIN SET	-Confirm GAP and difference of height
Assembly	-Assemble left side of MAIN SET left side.	-Confirm GAP and difference of height
Assembly	-Assemble lower portion of MAIN SET	-Confirm GAP and difference of height

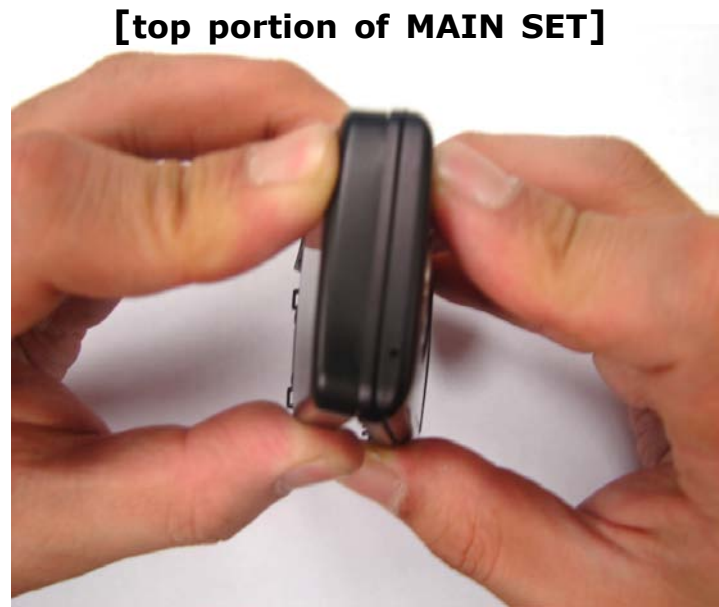

Warning

■ Assemble so that Flexure and White screen don't happen at top portion HOOK region assembly of SET.

[tension Test]



INSTUMENTS TO BE USED				
NO	MATERIAL	CODE	STANDRAD	Quan
1	REAR ASS'Y	GH97-05191A	D520/D528	1EA
2				
3				
4				
5				
6				

Application		SGH-D520/D528	
Subject		Work Description NO	
REAR Assembly and tesion test		26	

ED	Date of revision	Revision contents
1		
2		
3		
4		

Warning

■ Screw TORQUE : 1.6kgf/m

Subject	Work contents	Confirmation and inspection standard
SCREW	-SCREW(4POINTS)	

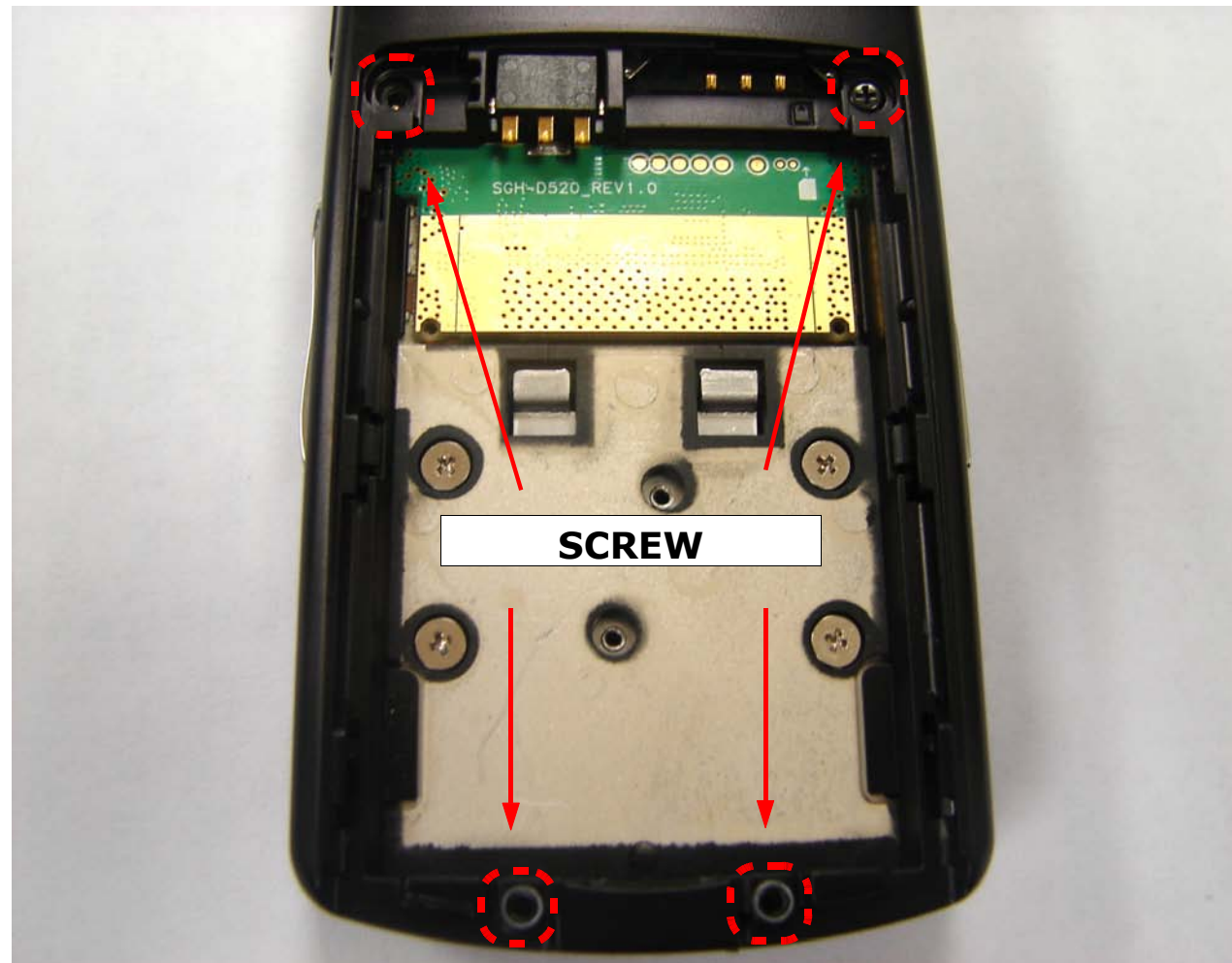

INSTUMENTS TO BE USED				
NO	MATERIAL	CODE	STANDRAD	Qua n
1	SCREW	6001-001478	M1.4,L3	1EA
2	BLACK TAPE	GH74-19614A	32.2X49.5X0.1T	1EA
3				
4				
5				
Application			SGH-D520/D528	
Subject			Work Description NO	
SCREW			27	
ED	Date of revision	Revision contents		
1				
2				
3				
4				

11-3. Slide FPCB KIT assembling

[Remove the paper on tape]



[Insert MAIN FPCB]

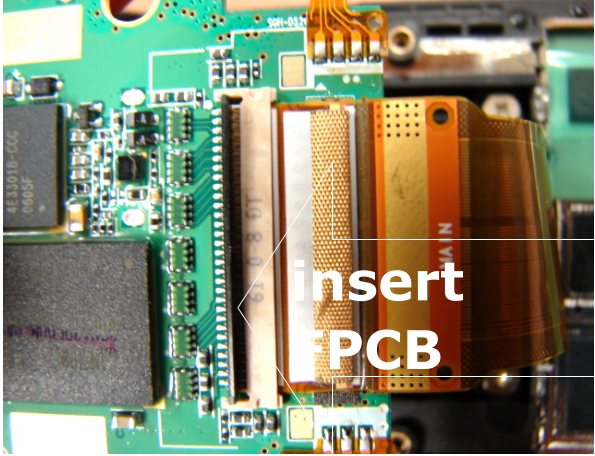

[Connect the Acuator]

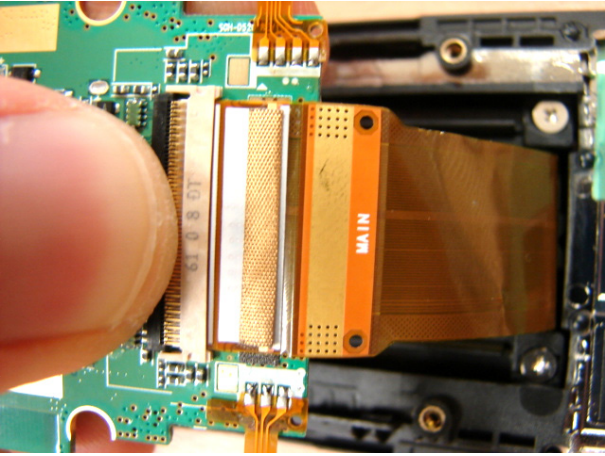

→

[Adhere the tape]

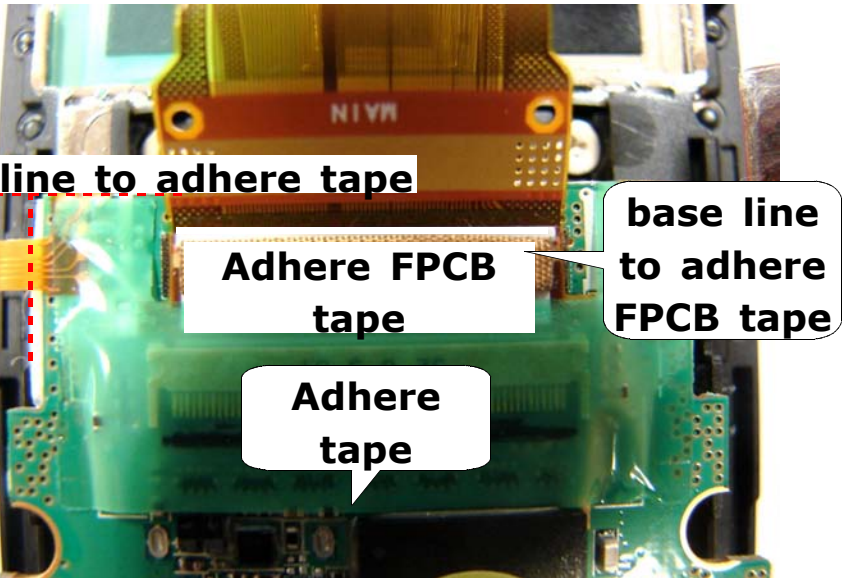

[Solder the PCB]

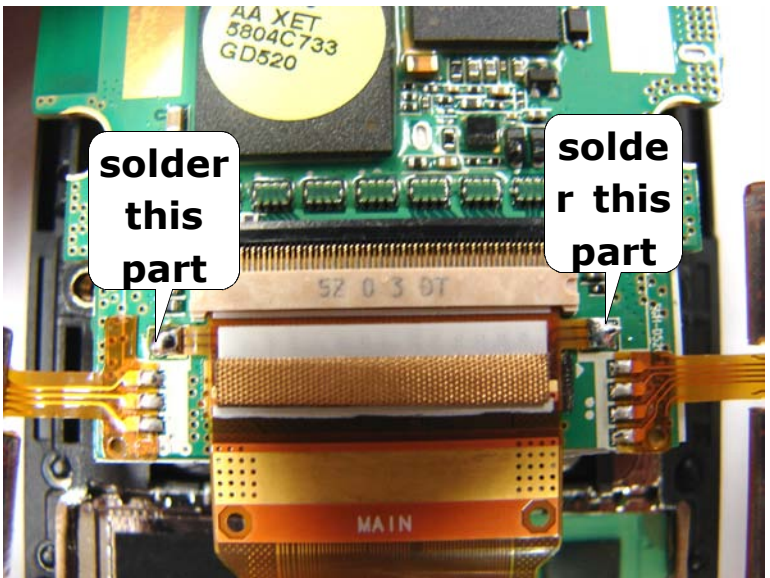

←

Warning

- Take care so that CHIP and SHORT may not happen
- Put on strap and gloves to remove electricity

Instruments to be used				
NO	MATERIAL	CODE	STANDARD	Quan
1	Soldering iron	-	350°~380°	1EA
2	Solder	-	SR-34 (PA TYPE)	1EA
3	JIG for solder	-	D520/D528	1EA
4				
5				
6				

Application		S G H - D 5 2 0 / D 5 2 8	
Subject			Work Description NO
connection and soldering of MAIN FPCB			24

ED	when to modify	what to modify
1		
2		
3		