

COMPAL CONFIDENTIAL

MODEL NAME : Goliad MLK 12 UMA ENTRY

PCB NO : LA-A972P

BOM P/N : 4319RK31LXX

GPIO MAP: 3.3b

Goliad MLK 12" UMA ENTRY

Broadwell U Processor

2013-12-23

REV : 0.2 (X01)

@ : Nopop Component

EMC@ : EMI, ESD and RF Component

@EMC@ : EMI, ESD and RF Nopop Component

CXDP@ : XDP Component

CONN@ : Connector Component

VPRO@ : Vpro Component

NVPRO@ : Non-Vpro Component



MB PCB	
Part Number	Description
D480002800	PCB 14A LA-A972P REV0 MB W/O DOCKING 2

PROPRIETARY NOTE: THIS SHEET OF ENGINEERING DRAWING AND SPECIFICATIONS CONTAINS CONFIDENTIAL TRADE SECRET AND OTHER PROPRIETARY INFORMATION OF DELL INC. ("DELL") THIS DOCUMENT MAY NOT BE TRANSFERRED OR COPIED WITHOUT THE EXPRESS WRITTEN AUTHORIZATION OF DELL. IN ADDITION, NEITHER THIS SHEET NOR THE INFORMATION IT CONTAINS MAY BE USED BY OR DISCLOSED TO ANY THIRD PARTY WITHOUT DELL'S EXPRESS WRITTEN CONSENT.

DELL CONFIDENTIAL/PROPRIETARY

		Compal Electronics, Inc.	
Title		Cover Sheet	
Size	Document Number	Rev	
	LA-A972P	0.1	
Date	Monday, March 17, 2014	Sheet	1 of 48

Goliad MLK 12 UMA Entry Block Diagram

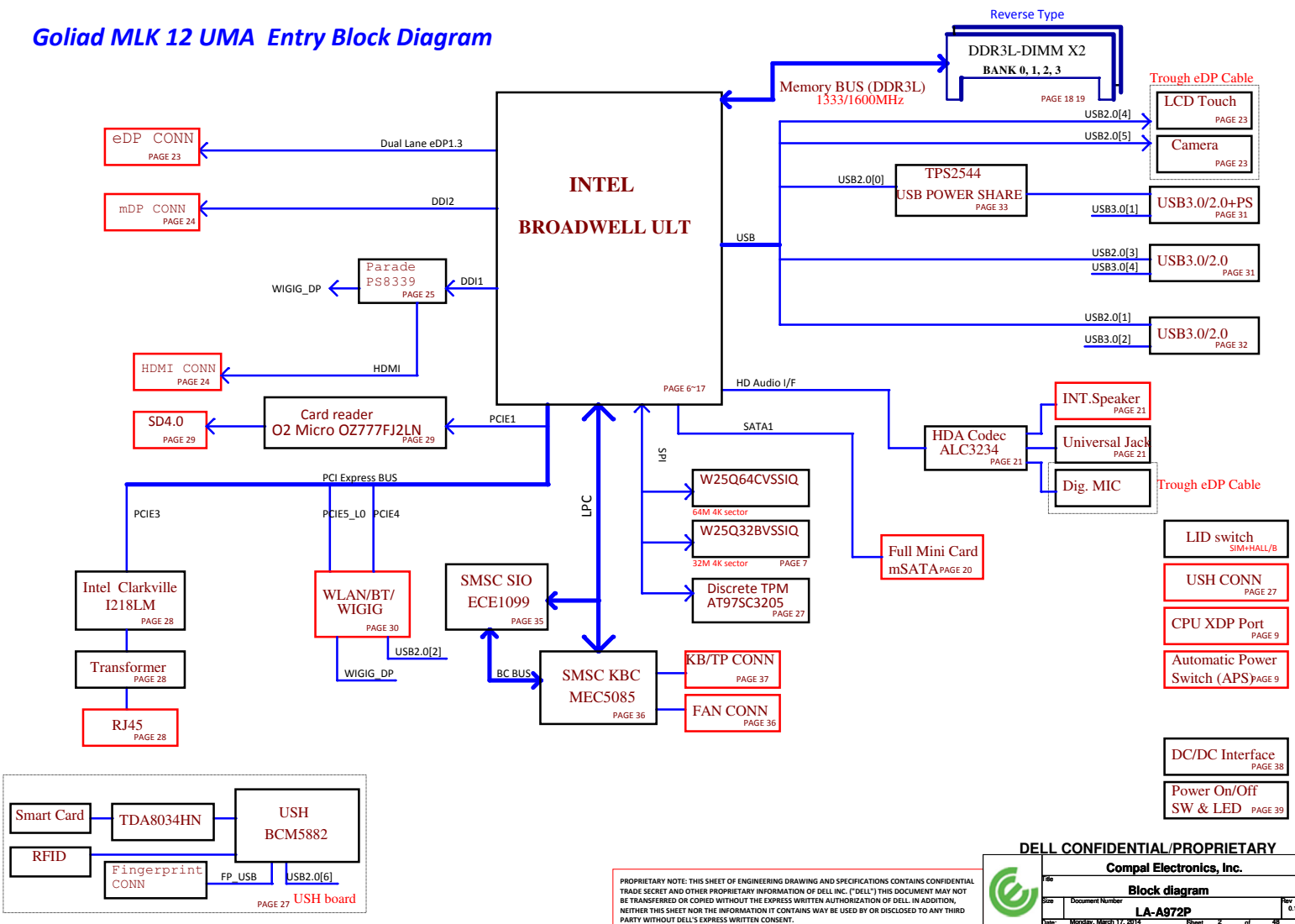

PROPRIETARY NOTE: THIS SHEET OF ENGINEERING DRAWING AND SPECIFICATIONS CONTAINS CONFIDENTIAL TRADE SECRET AND OTHER PROPRIETARY INFORMATION OF DELL INC. ("DELL") THIS DOCUMENT MAY NOT BE TRANSFERRED OR COPIED WITHOUT THE EXPRESS WRITTEN AUTHORIZATION OF DELL. IN ADDITION, NEITHER THIS SHEET NOR THE INFORMATION IT CONTAINS MAY BE USED BY OR DISCLOSED TO ANY THIRD PARTY WITHOUT DELL'S EXPRESS WRITTEN CONSENT.

DELL CONFIDENTIAL/PROPRIETARY

Compal Electronics, Inc.

Block diagram

File: _____

Doc Number: **LA-A872P**

Date: Monday, March 17, 2014

Sheet 2 of 48

Rev 0.1

POWER STATES

State \ Signal	SLP S3#	SLP S4#	SLP S5#	SLP A#	ALWAYS PLANE	M PLANE	SUS PLANE	RUN PLANE	CLOCKS
S0 (Full ON) / M0	HIGH	HIGH	HIGH	HIGH	ON	ON	ON	ON	ON
S3 (Suspend to RAM) / M3	LOW	HIGH	HIGH	HIGH	ON	ON	ON	OFF	OFF
S4 (Suspend to DISK) / M3	LOW	LOW	HIGH	HIGH	ON	ON	OFF	OFF	OFF
S5 (SOFT OFF) / M3	LOW	LOW	LOW	HIGH	ON	ON	OFF	OFF	OFF
S3 (Suspend to RAM) / M-OFF	LOW	HIGH	HIGH	LOW	ON	OFF	ON	OFF	OFF
S4 (Suspend to DISK) / M-OFF	LOW	LOW	HIGH	LOW	ON	OFF	OFF	OFF	OFF
S5 (SOFT OFF) / M-OFF	LOW	LOW	LOW	LOW	ON	OFF	OFF	OFF	OFF

PM TABLE

State \ power plane	+5V_ALW +3.3V_ALW +3.3V_ALW_PCH +3.3V_RTC_LDO	+3.3V_SUS +1.35V_MEM	+5V_RUN +3.3V_RUN +0.675V_DDR_VTT +1.05V_RUN +VCC_CORE	+3.3V_M +1.05V_M	+3.3V_M +1.05V_M (M-OFF)
S0	ON	ON	ON	ON	ON
S3	ON	ON	OFF	ON	OFF
S5 S4/AC	ON	OFF	OFF	ON	OFF
S5 S4/AC doesn't exist	OFF	OFF	OFF	OFF	OFF

PCIE	USB3.0	SATA	DESTINATION
	USB3.0 1		JUSB1-->Rear left
	USB3.0 2		JUSB3-->Right
PCIE 1	USB3.0 3		MMI (CARD READER)
PCIE 2	USB3.0 4		JUSB2-->Rear Right
PCIE 3			LOM
PCIE 4			WLAN - JNGFF1
PCIE 5			WiGig - JNGFF1
PCIE 6		SATA 3	NA
		SATA 2	NA
		SATA 1	JMINI3
		SATA 0	NA

BDW ULT	USB PORT#	DESTINATION
	0	JUSB1
	1	JUSB3
	2	WLAN + BT
	3	JUSB2
	4	Touch Screen
	5	CAMERA
	6	USH
7	WWAN	

USH	0	BIO
	1	NA

PROPRIETARY NOTE: THIS SHEET OF ENGINEERING DRAWING AND SPECIFICATIONS CONTAINS CONFIDENTIAL TRADE SECRET AND OTHER PROPRIETARY INFORMATION OF DELL INC. ("DELL") THIS DOCUMENT MAY NOT BE TRANSFERRED OR COPIED WITHOUT THE EXPRESS WRITTEN AUTHORIZATION OF DELL. IN ADDITION, NEITHER THIS SHEET NOR THE INFORMATION IT CONTAINS MAY BE USED BY OR DISCLOSED TO ANY THIRD PARTY WITHOUT DELL'S EXPRESS WRITTEN CONSENT.

DELL CONFIDENTIAL/PROPRIETARY

Compal Electronics, Inc.

File: **Port assignment**

Size: Document Number **LA-A972P** Rev: 0.1

Date: Monday, March 17, 2014 Sheet 3 of 40

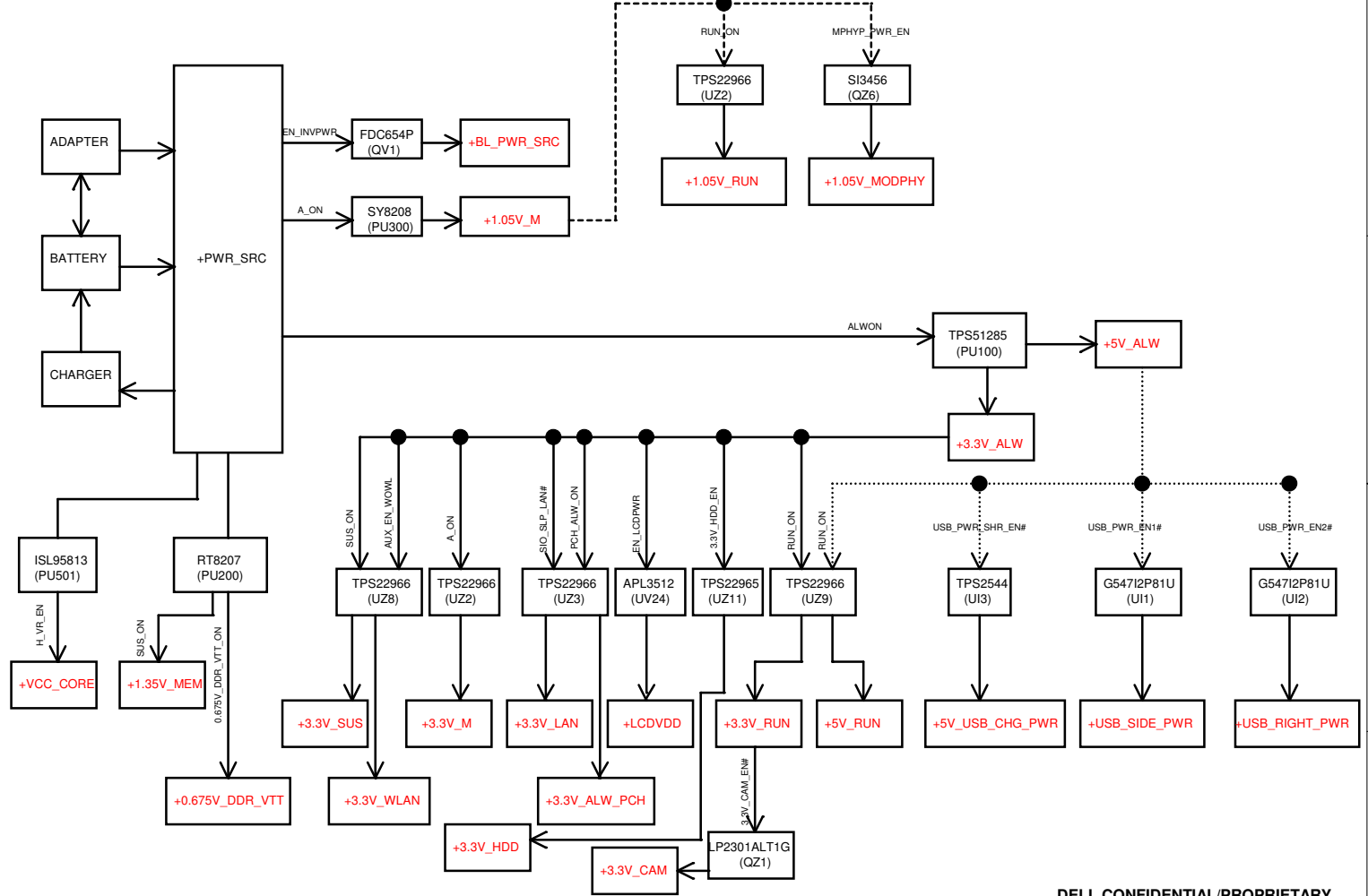

DELL CONFIDENTIAL/PROPRIETARY

Compal Electronics, Inc.

File		Rev	
Document Number		6.1	
LA-A972P			
Date	Monday, March 17, 2014	Sheet	4 of 40

PROPRIETARY NOTE: THIS SHEET OF ENGINEERING DRAWING AND SPECIFICATIONS CONTAINS CONFIDENTIAL TRADE SECRET AND OTHER PROPRIETARY INFORMATION OF DELL INC. ("DELL"). THIS DOCUMENT MAY NOT BE TRANSFERRED OR COPIED WITHOUT THE EXPRESS WRITTEN AUTHORIZATION OF DELL. IN ADDITION, NEITHER THIS SHEET NOR THE INFORMATION IT CONTAINS MAY BE USED BY OR DISCLOSED TO ANY THIRD PARTY WITHOUT DELL'S EXPRESS WRITTEN CONSENT.

SMBUS Address [0x9a]

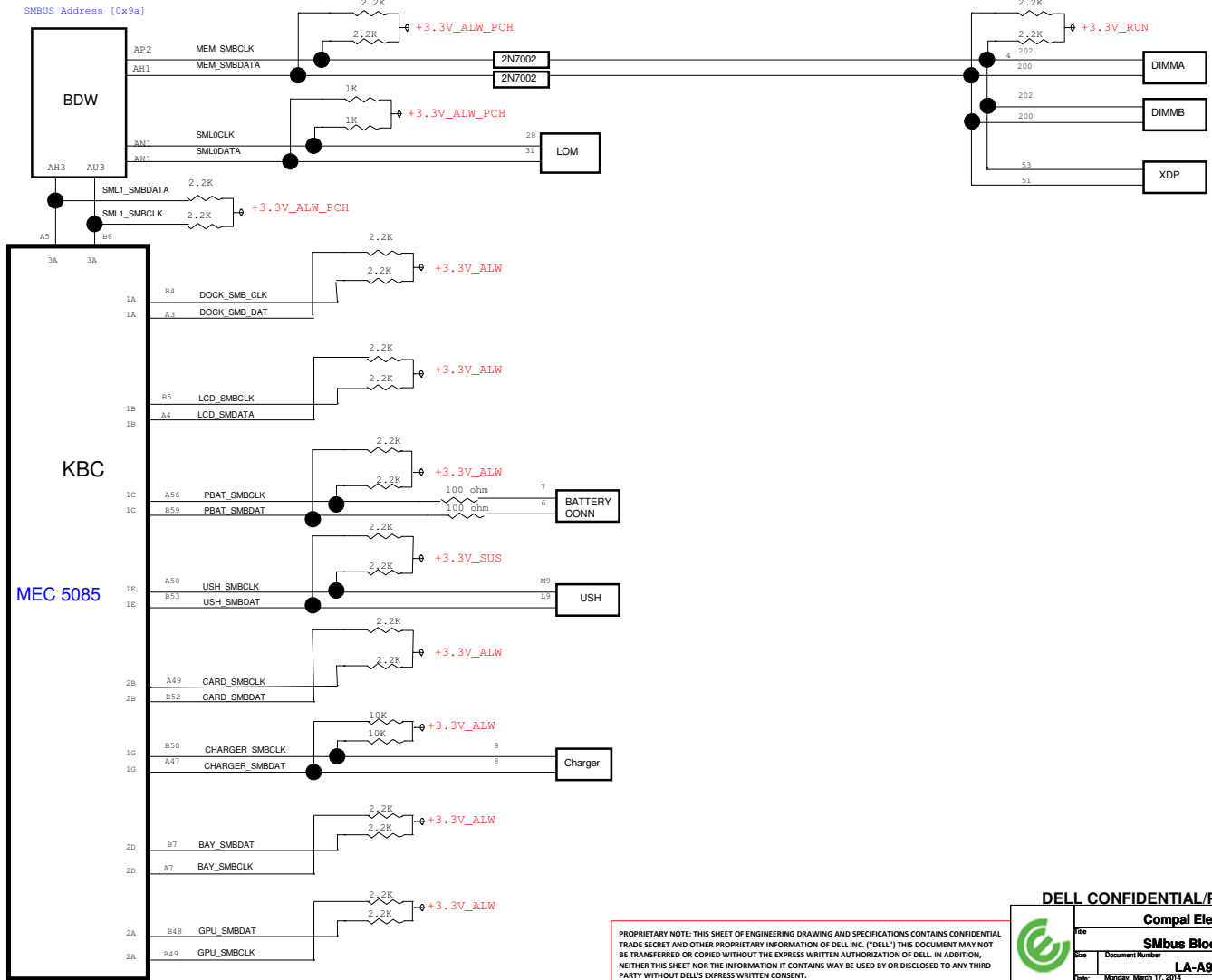

PROPRIETARY NOTE: THIS SHEET OF ENGINEERING DRAWING AND SPECIFICATIONS CONTAINS CONFIDENTIAL TRADE SECRET AND OTHER PROPRIETARY INFORMATION OF DELL INC. ("DELL") THIS DOCUMENT MAY NOT BE TRANSFERRED OR COPIED WITHOUT THE EXPRESS WRITTEN AUTHORIZATION OF DELL. IN ADDITION, NEITHER THIS SHEET NOR THE INFORMATION IT CONTAINS MAY BE USED BY OR DISCLOSED TO ANY THIRD PARTY WITHOUT DELL'S EXPRESS WRITTEN CONSENT.

DELL CONFIDENTIAL/PROPRIETARY

Compal Electronics, Inc.

SMBus Block diagram

LA-A972P

Monday, March 17, 2014 Sheet 5 of 40

UMA SATA port

SATA0	SATA1	PCB	SATA2/PCIe6 L1	SATA3/PCIe6 L0	
E-Dock	mSATA	G12 UMA	M2 3042 2nd PCIe Lane for PCIe Cache	M2 3042 (HCA & SATA-Cache)	contact to WWAN
NA	mSATA	G12 Entry	NA	NA	
E-Dock	mSATA	G14 DSC	M2 3042 SATA-Cache(no HCA)	M2 3030 WIGIG	SATA2/PCIe6_L1 contact to WWAN SATA3/PCIe6 L0 contact to WLAN
E-Dock	HDD	G14 UMA	M2 3042 2nd PCIe Lane for PCIe Cache	M2 3042 (HCA & SATA-Cache)	contact to WWAN
NA	mSATA	G14D_En	NA	M2 3030 WIGIG	contact to WLAN
NA	HDD	G14U_En	NA	NA	

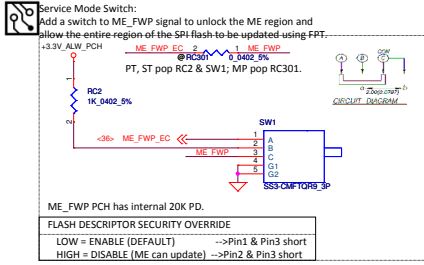

INTVRMEN - INTEGRATED SUS 1.05V VRM ENABLE
High - Enable Internal VRs
Low - Enable External VRs

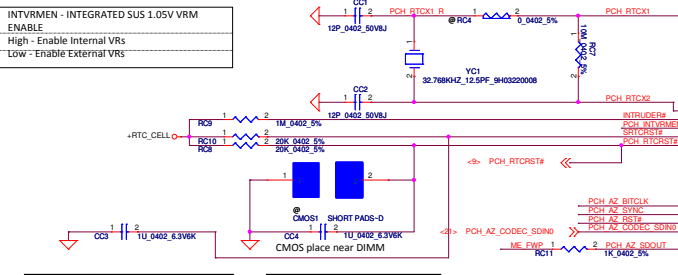

ME_CLR1
Shunt Clear ME RTC Registers
Open Keep ME RTC Registers

CMOS_CLR1
Shunt Clear CMOS
Open Keep CMOS

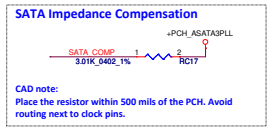
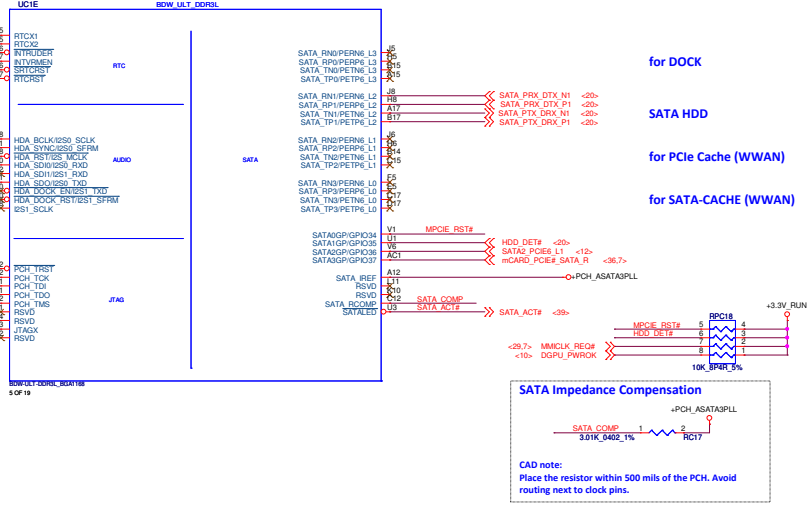
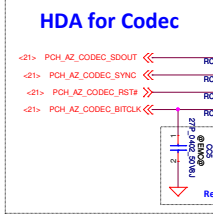
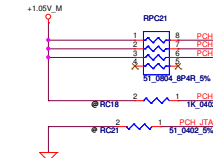

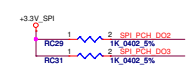
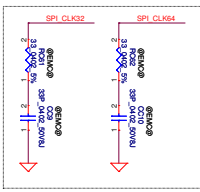
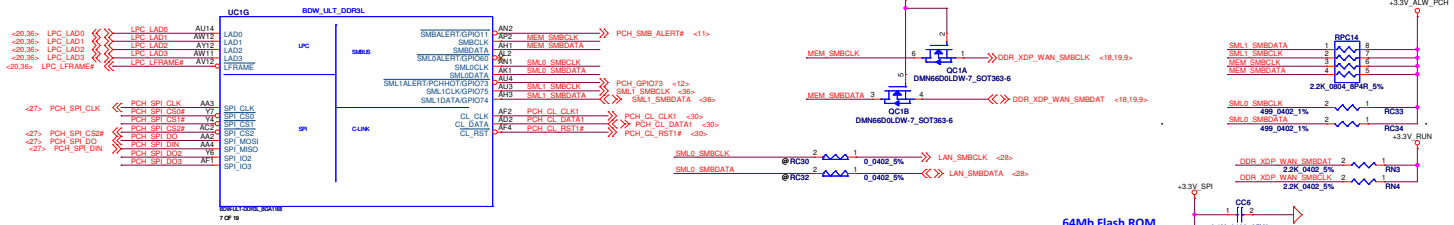

SOFTWARE TAA

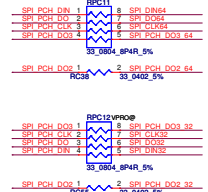

PCIECLK for UMA

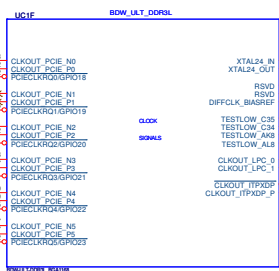
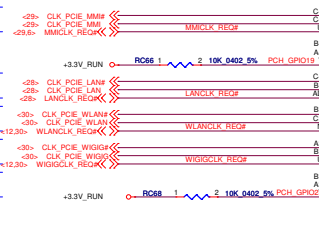
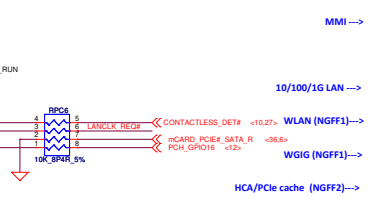

64Mb Flash ROM

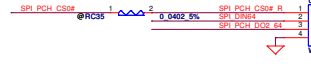

32Mb Flash ROM

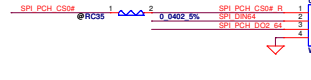

32Mb Flash ROM



PCB	PCIE1	PCIE2	PCIE3	PCIE4	PCIE5	PCIE6
G12 UMA	SD card	NA	LOM	WLAN	WIGIG	M2 3042 (HCA & SATA-Cache)
G12 Entry	SD card	NA	LOM	WLAN	WIGIG	NA
G14 DSC	SD card	NA	LOM	WLAN	GPU	WIGIG
G14 UMA	SD card	NA	LOM	WLAN	WIGIG	M2 3042 (HCA & SATA-Cache)
G14U_En	SD card	NA	LOM	WLAN	GPU	WIGIG
G14U_En	SD card	NA	LOM	WLAN	WIGIG	NA

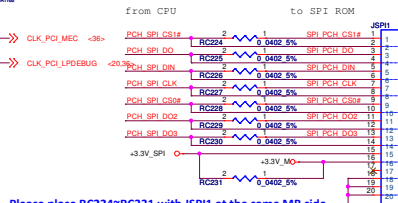
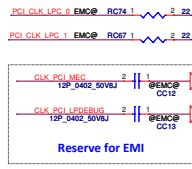

support SPI TPM		support LPC TPM	
LPC_0	LPC_1	LPC_0	LPC_1
SIO	DOCK	CLKBUFF	DOCK
MEC	DEBUG	SIO	MEC
		TPM	DEBUG

Please place RC224~RC331 with JSP1 at the same MB side.

DELL CONFIDENTIAL/PROPRIETARY

Compal Electronics, Inc.

File: **CPU (2/12)**

Size: _____ Document Number: **LA-A972P** Rev: 0.1

Date: Monday, March 17, 2014 Sheet: 7 of 8

PROPRIETARY NOTE: THIS SHEET OF ENGINEERING DRAWING AND SPECIFICATIONS CONTAINS CONFIDENTIAL TRADE SECRET AND OTHER PROPRIETARY INFORMATION OF DELL INC. ("DELL") THIS DOCUMENT MAY NOT BE TRANSFERRED OR COPIED WITHOUT THE EXPRESS WRITTEN AUTHORIZATION OF DELL. IN ADDITION, NEITHER THIS SHEET NOR THE INFORMATION IT CONTAINS MAY BE USED BY OR DISCLOSED TO ANY THIRD PARTY WITHOUT DELL'S EXPRESS WRITTEN CONSENT.

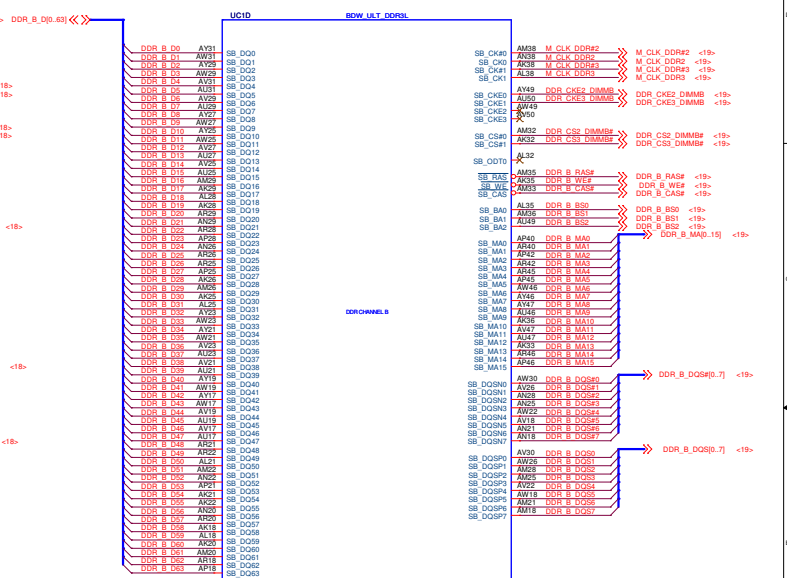
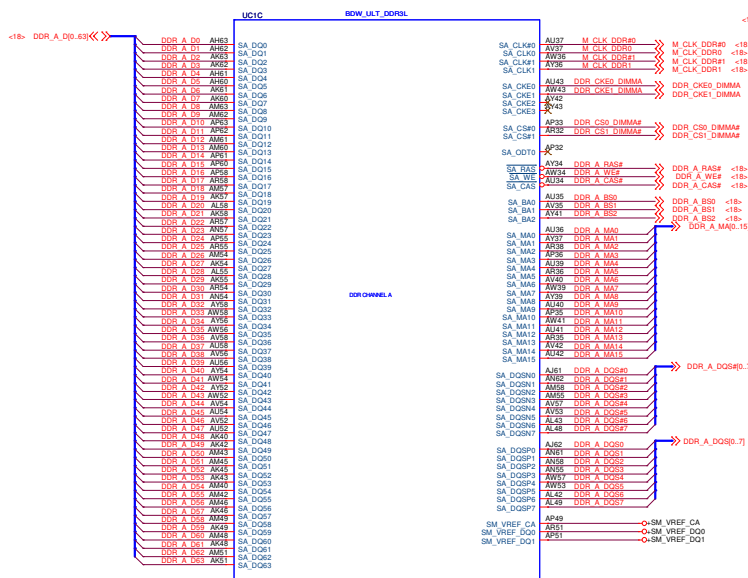

UC1C UC1D

PROPRIETARY NOTE: THIS SHEET OF ENGINEERING DRAWING AND SPECIFICATIONS CONTAINS CONFIDENTIAL TRADE SECRET AND OTHER PROPRIETARY INFORMATION OF DELL INC. ("DELL"). THIS DOCUMENT MAY NOT BE TRANSFERRED OR COPIED WITHOUT THE EXPRESS WRITTEN AUTHORIZATION OF DELL. IN ADDITION, NEITHER THIS SHEET NOR THE INFORMATION IT CONTAINS MAY BE USED BY OR DISCLOSED TO ANY THIRD PARTY WITHOUT DELL'S EXPRESS WRITTEN CONSENT.

DELL CONFIDENTIAL/PROPRIETARY
Compal Electronics, Inc.

Rev	CPU (3/12)		Rev
Date	Document Number	LA-A972P	Rev
Issue	Monday, March 17, 2014	Sheet	8 of 48

PCIe for UMA

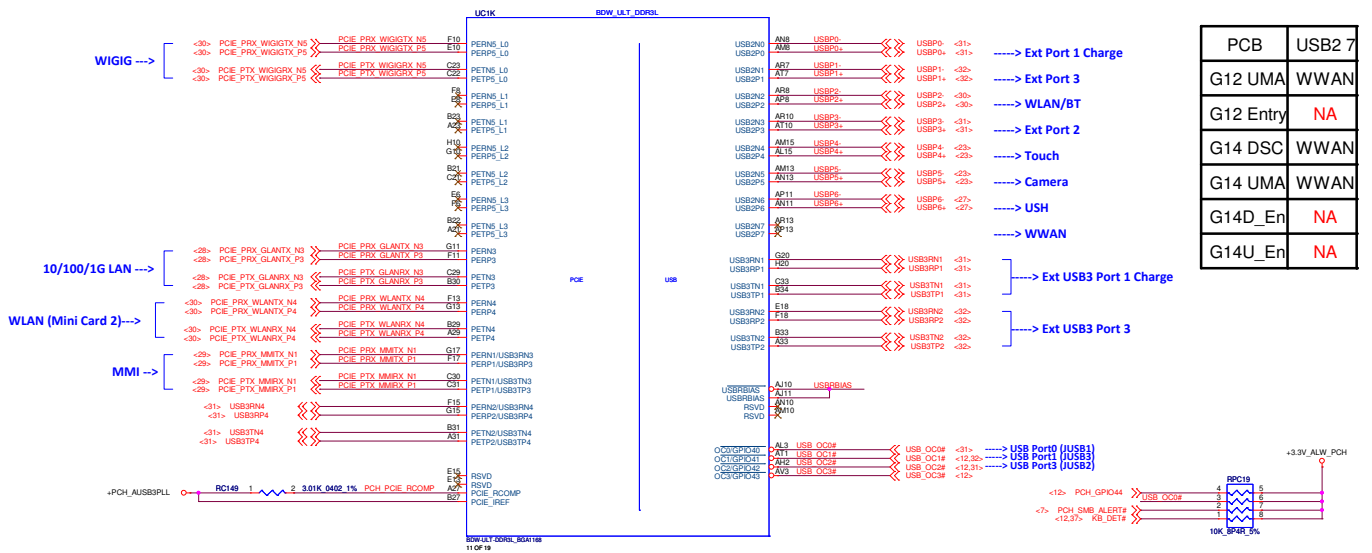

PCB	USB2 7
G12 UMA	WWAN
G12 Entry	NA
G14 DSC	WWAN
G14 UMA	WWAN
G14D_En	NA
G14U_En	NA

PCB	PCIE1	PCIE2	PCIE3	PCIE4	PCIE5	PCIE6
G12 UMA	SD card	NA	LOM	WLAN	WIGIG	M2 3042 (HCA & SATA-Cache)
G12 Entry	SD card	NA	LOM	WLAN	WIGIG	NA
G14 DSC	SD card	NA	LOM	WLAN	GPU	WIGIG
G14 UMA	SD card	NA	LOM	WLAN	WIGIG	M2 3042 (HCA & SATA-Cache)
G14D_En	SD card	NA	LOM	WLAN	GPU	WIGIG
G14U_En	SD card	NA	LOM	WLAN	WIGIG	NA

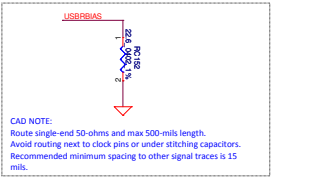

DELL CONFIDENTIAL/PROPRIETARY

		Compal Electronics, Inc. CPU (6/12)	
		Size: Document Number LA-A972P	Rev: 6.1
Date: Monday, March 17, 2014		Sheet 11 of 48	

PROPRIETARY NOTE: THIS SHEET OF ENGINEERING DRAWING AND SPECIFICATIONS CONTAINS CONFIDENTIAL TRADE SECRET AND OTHER PROPRIETARY INFORMATION OF DELL INC. ("DELL"). THIS DOCUMENT MAY NOT BE TRANSFERRED OR COPIED WITHOUT THE EXPRESS WRITTEN AUTHORIZATION OF DELL. IN ADDITION, NEITHER THIS SHEET NOR THE INFORMATION IT CONTAINS MAY BE USED BY OR DISCLOSED TO ANY THIRD PARTY WITHOUT DELL'S EXPRESS WRITTEN CONSENT.

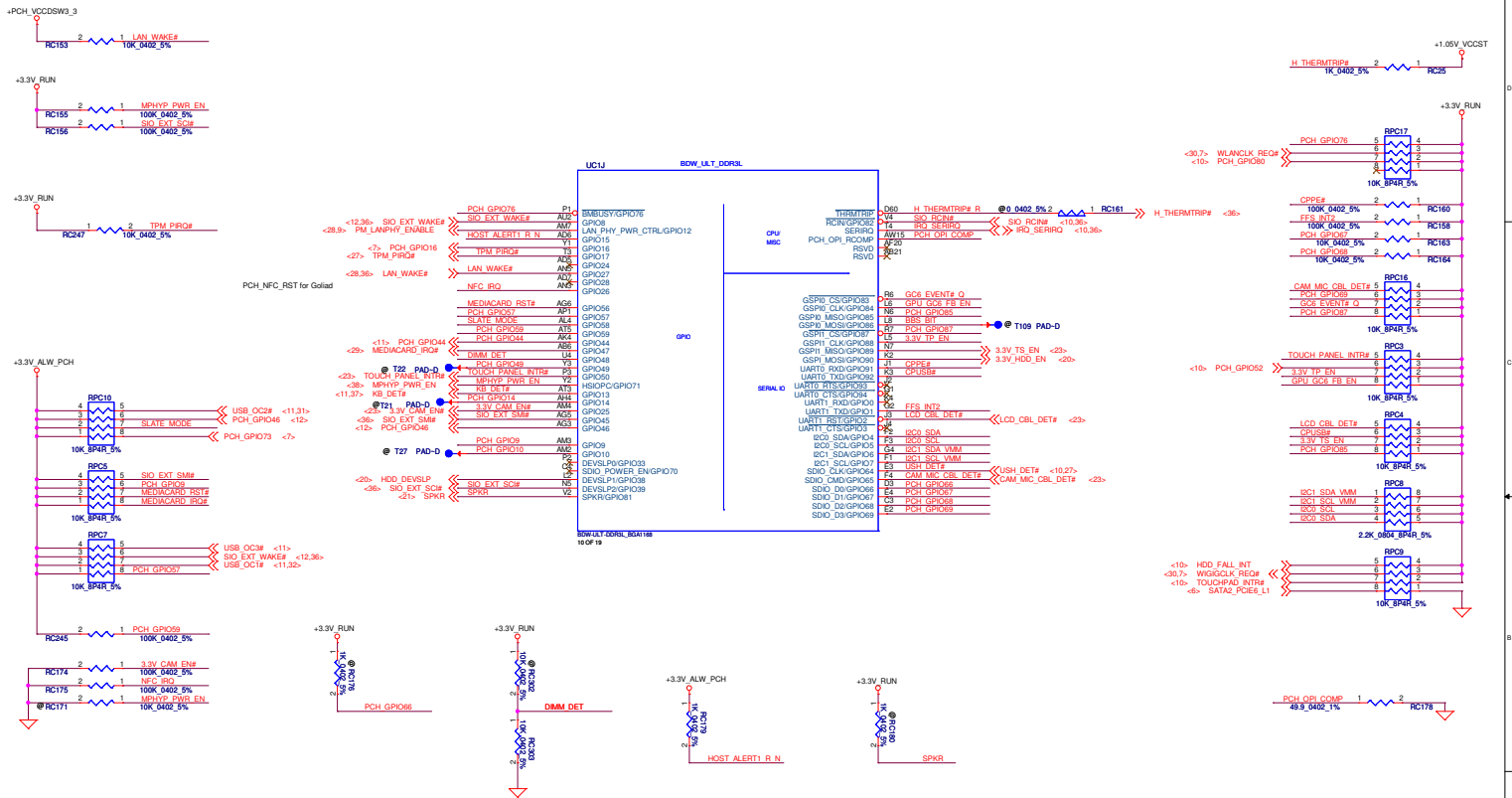

TOP-BLOCK SWAP OVERRIDE		DIMM Detect		TLS CONFIDENTIALITY		No Reboot on TCO Timer expiration	
HIGH	ENABLE	HIGH	1 DIMM	HIGH	ENABLE	HIGH	ENABLE
LOW(DEFAULT)	DISABLE	LOW	2 DIMM	LOW(DEFAULT)	DISABLE	LOW(DEFAULT)	DISABLE

DELL CONFIDENTIAL/PROPRIETARY

Compal Electronics, Inc.

CPU (712)

LA-A972P

Monday, March 17, 2014

PROPRIETARY NOTE: THIS SHEET OF ENGINEERING DRAWING AND SPECIFICATIONS CONTAINS CONFIDENTIAL TRADE SECRET AND OTHER PROPRIETARY INFORMATION OF DELL INC. ("DELL"). THIS DOCUMENT MAY NOT BE TRANSFERRED OR COPIED WITHOUT THE EXPRESS WRITTEN AUTHORIZATION OF DELL. IN ADDITION, NEITHER THIS SHEET NOR THE INFORMATION IT CONTAINS MAY BE USED BY OR DISCLOSED TO ANY THIRD PARTY WITHOUT DELL'S EXPRESS WRITTEN CONSENT.

CFG STRAPS for CPU

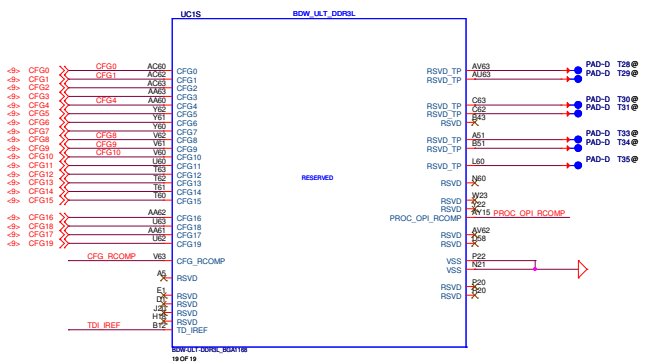

EAR-STALL/NOT STALL RESET SEQUENCE AFTER PCU PLL IS LOCKE	
CFG0	1:(Default) Normal Operation; No stall 0:Lane Reversed

PCH/PCH LESS MODE SELECTION	
CFG1	1:(Default) Normal Operation 0:Lane Reversed

SAFE MODE BOOT	
CFG10	1: POWER FEATURES ACTIVATED DURING RESET 0: POWER FEATURES (ESPECIALLY CLOCK GATINE ARE NOT ACTIVATED

NO SVID PROTOCOL CAPABLE VR CONNECTED	
CFG9	1: VRS support SVID protocol are present 0:No VR support SVID is present The chip will not generate(OR Respond to) SVID activity

ALLOW THE USE OF NOA ON LOCKED UNITS	
CFG8	1: Enable(Default): Noa will be disable in locked units and enable in un-locked 0:Disable Noa will be available pegrardless of the locking of the unit

Display Port Presence Strap	
CFG4	1 : Disabled; No Physical Display Port attached to Embedded Display Port 0 : Enabled; An external Display Port device is connected to the Embedded Display Port

DELL CONFIDENTIAL/PROPRIETARY

Compal Electronics, Inc.	
CPU (8/12)	
File	LA-A972P
Size	Document Number
Date	Monday, March 17, 2014
Sheet	13 of 45
Rev	0.1

PROPRIETARY NOTE: THIS SHEET OF ENGINEERING DRAWING AND SPECIFICATIONS CONTAINS CONFIDENTIAL TRADE SECRET AND OTHER PROPRIETARY INFORMATION OF DELL INC. ("DELL") THIS DOCUMENT MAY NOT BE TRANSFERRED OR COPIED WITHOUT THE EXPRESS WRITTEN AUTHORIZATION OF DELL. IN ADDITION, NEITHER THIS SHEET NOR THE INFORMATION IT CONTAINS MAY BE USED BY OR DISCLOSED TO ANY THIRD PARTY WITHOUT DELL'S EXPRESS WRITTEN CONSENT.

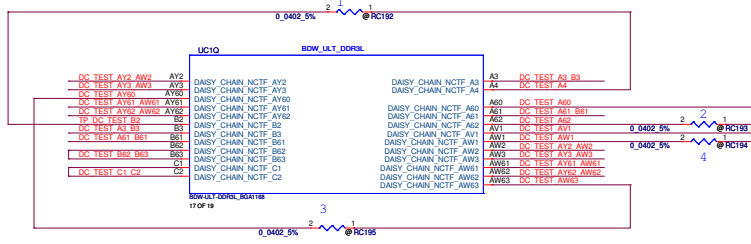

- Package Daisy Chain:**
- 1.B2-PKG-C1-PCB-C2-PKG-B3-PCB-A3-PKG-A4
 - 2.A62-PKG-A61-PCB-B61-PKG-B62-PCB-B63-PKG-A60
 - 3.AY60-PKG-AW61-PCB-AY61-PKG-AW62-PCB-AY62-PKG-AW63
 - 4.AW1-PKG-AW3-PCB-AY3-PKG-AW2-PCB-AY2-PKG-AV1

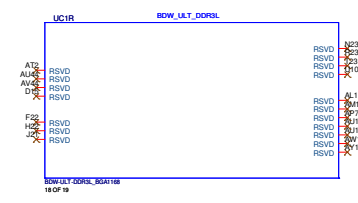

DELL CONFIDENTIAL/PROPRIETARY

Compal Electronics, Inc.



File	CPU (9/12)	
Size	Document Number	Rev
	LA-A972P	0.1
Date	Monday, March 17, 2014	Sheet 14 of 48

PROPRIETARY NOTE: THIS SHEET OF ENGINEERING DRAWING AND SPECIFICATIONS CONTAINS CONFIDENTIAL TRADE SECRET AND OTHER PROPRIETARY INFORMATION OF DELL INC. ("DELL") THIS DOCUMENT MAY NOT BE TRANSFERRED OR COPIED WITHOUT THE EXPRESS WRITTEN AUTHORIZATION OF DELL. IN ADDITION, NEITHER THIS SHEET NOR THE INFORMATION IT CONTAINS MAY BE USED BY OR DISCLOSED TO ANY THIRD PARTY WITHOUT DELL'S EXPRESS WRITTEN CONSENT.

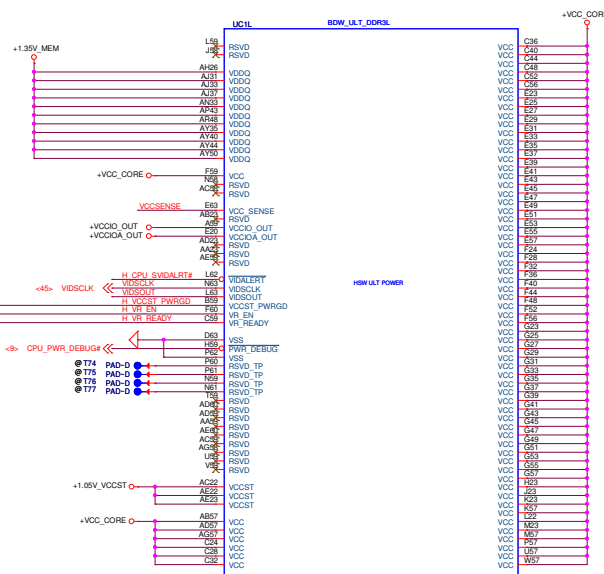
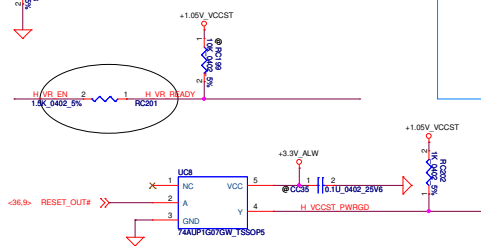
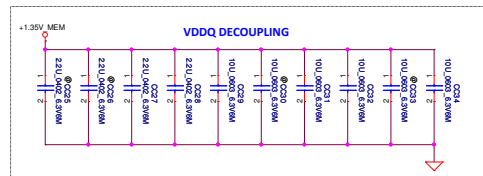
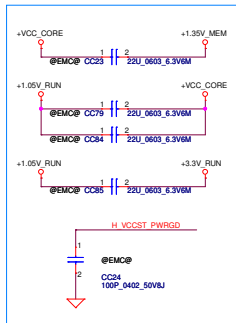
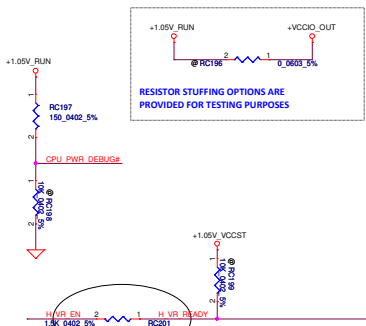

SVID ALERT

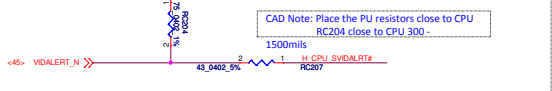

SVID DATA

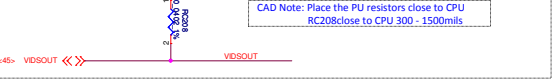

VCC_SENSE

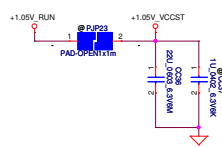
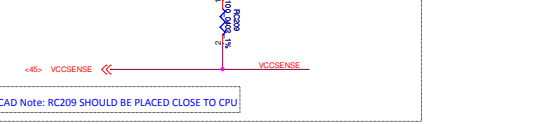

DELL CONFIDENTIAL/PROPRIETARY

Compal Electronics, Inc.	
Doc	CPU (10/12)
Size	Document Number
LA-A972P	
Date	Monday, March 17, 2014
Sheet	15 of 48

PROPRIETARY NOTE: THIS SHEET OF ENGINEERING DRAWING AND SPECIFICATIONS CONTAINS CONFIDENTIAL TRADE SECRET AND OTHER PROPRIETARY INFORMATION OF DELL INC. ("DELL") THIS DOCUMENT MAY NOT BE TRANSFERRED OR COPIED WITHOUT THE EXPRESS WRITTEN AUTHORIZATION OF DELL. IN ADDITION, NEITHER THIS SHEET NOR THE INFORMATION IT CONTAINS MAY BE USED BY OR DISCLOSED TO ANY THIRD PARTY WITHOUT DELL'S EXPRESS WRITTEN CONSENT.

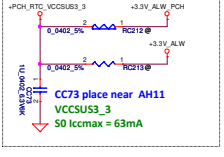
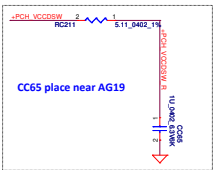
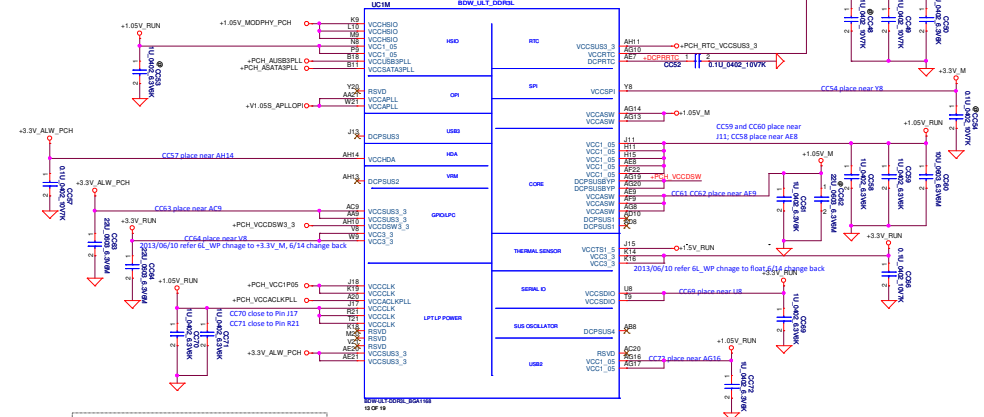
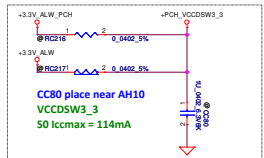
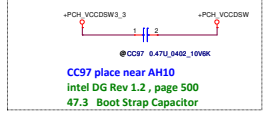
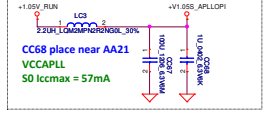
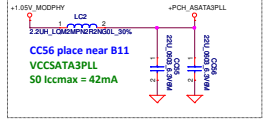
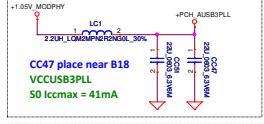
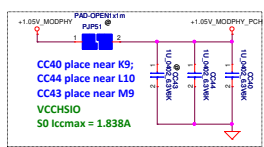

Voltage Rail	Voltage (V)	S0 Iccmax Current (A)	Sx Iccmax Current (A)	Deep-Sx Iccmax (A)	G3
VCCIO5 (Internal Suspend VR mode using HTVRM0)	1.05	1.741	0	0	0
VCCIO5 (External Suspend VR mode using HTVRM0)	1.05	1.632	0	0	0
VCCAPLL	1.05	0.057	0	0	0
VCCSATA3PLL	1.05	0.042	0	0	0
VCCUSB3PLL	1.05	0.041	0	0	0
VCCACLKPLL	1.05	0.031	0	0	0
VCCCLK	1.05	0.290	0	0	0
VCCHSIO	1.05	1.838	0	0	0
VCCSW3_5	1.5	0.003	0	0	0
VCC1_3	3.3	0.041	0	0	0
VCCSDIO	3.3	0.017	0	0	0
VCCASW	1.05	0.658	0	0	0
VCCSP1	3.3	0.058	0	0	0
VCCBDA	3.3	0.011	<1 mA	0	0
VCCSW3_3 (Internal Suspend VR mode using HTVRM0)	3.3	0.063	0.024	0	0
VCCSW3_3 (External Suspend VR mode using HTVRM0)	3.3	0.062	0.005	0	0
DcpSus1*	1.05	0.109	0.014	0	0
DcpSus2*	1.05	0.025	0.001	0	0
DcpSus3*	1.05	0.010	0.001	0	0
DcpSus4*	1.05	0.001	0.001	0	0
VCCDSW2_3	3.3	0.114	0.004	0.002	0
VCCRTC	3.3	<1 mA	<1 mA	<1 mA	See notes 1, 2

Reminder below power rail need isolation for layout refer attach file for more detail that from Intel review feedback.

Power Rail Isolation

Voltage Supply	Interface (power rail isolation required)	PCH Pins sharing power rail
V1.05v	Core	Z11, H11, H15, A81, A82
	DIE	W21
	HSD	K9, L10, M1, P9, B18, B11, M9
	USB2	AG16, AG17
	CLK(A)	A20
V3.3v	CLK(B)	B21, Y21
	CLK(C)	J18, K19
V3.3v	LSPD	ACE, A85, A820, A821
	RTC	AH11
	HDA	AH14
V3.3v	GPIO	W8, W9
	USBD	U8, T9
	Thermal Sensor	K14, K15

PROPRIETARY NOTE: THIS SHEET OF ENGINEERING DRAWING AND SPECIFICATIONS CONTAINS CONFIDENTIAL TRADE SECRET AND OTHER PROPRIETARY INFORMATION OF DELL INC. ("DELL") THIS DOCUMENT MAY NOT BE TRANSMITTED OR COPIED WITHOUT THE EXPRESS WRITTEN AUTHORIZATION OF DELL. IN ADDITION, NEITHER THIS SHEET NOR THE INFORMATION IT CONTAINS MAY BE USED BY OR DISCLOSED TO ANY THIRD PARTY WITHOUT DELL'S EXPRESS WRITTEN CONSENT.

DELL CONFIDENTIAL/PROPRIETARY

Compal Electronics, Inc.

File: **CPU (11/12)**

Rev: **LA-A972P**

Date: Monday, March 17, 2014 8:18:18 AM

Sheet: 18 of 48

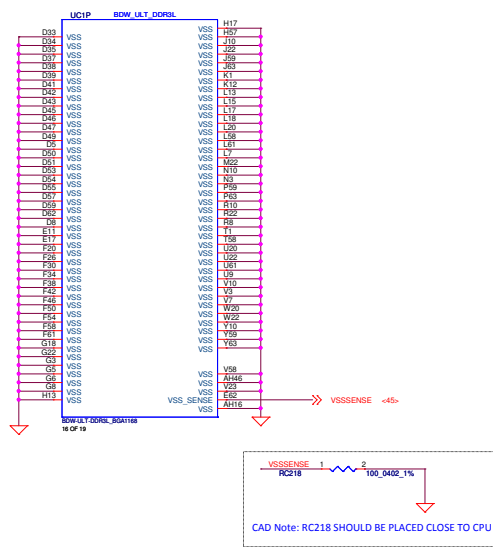
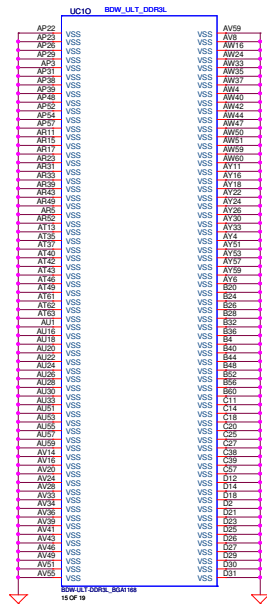
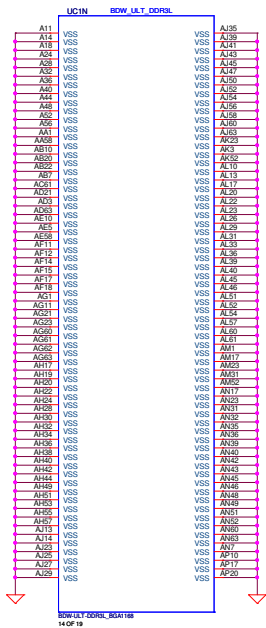

DELL CONFIDENTIAL/PROPRIETARY

Compal Electronics, Inc.	
CPU (12/12)	
Doc No	LA-A972P
Date	Monday, March 17, 2014
Sheet	17 of 48

PROPRIETARY NOTE: THIS SHEET OF ENGINEERING DRAWING AND SPECIFICATIONS CONTAINS CONFIDENTIAL TRADE SECRET AND OTHER PROPRIETARY INFORMATION OF DELL INC. ("DELL"). THIS DOCUMENT MAY NOT BE TRANSFERRED OR COPIED WITHOUT THE EXPRESS WRITTEN AUTHORIZATION OF DELL. IN ADDITION, NEITHER THIS SHEET NOR THE INFORMATION IT CONTAINS MAY BE USED BY OR DISCLOSED TO ANY THIRD PARTY WITHOUT DELL'S EXPRESS WRITTEN CONSENT.

- DDR_A_DQS[0-7]
- DDR_A_DS[0-6]
- DDR_A_DQS[7]
- DDR_A_MQ[0-15]

Layout Note:
Place near JDIMM1

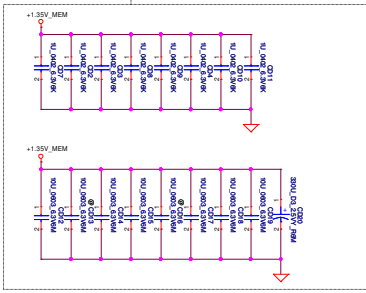

Layout Note:
Place near JDIMM1.203_204

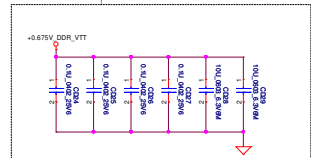

H=4mm Reverse Type

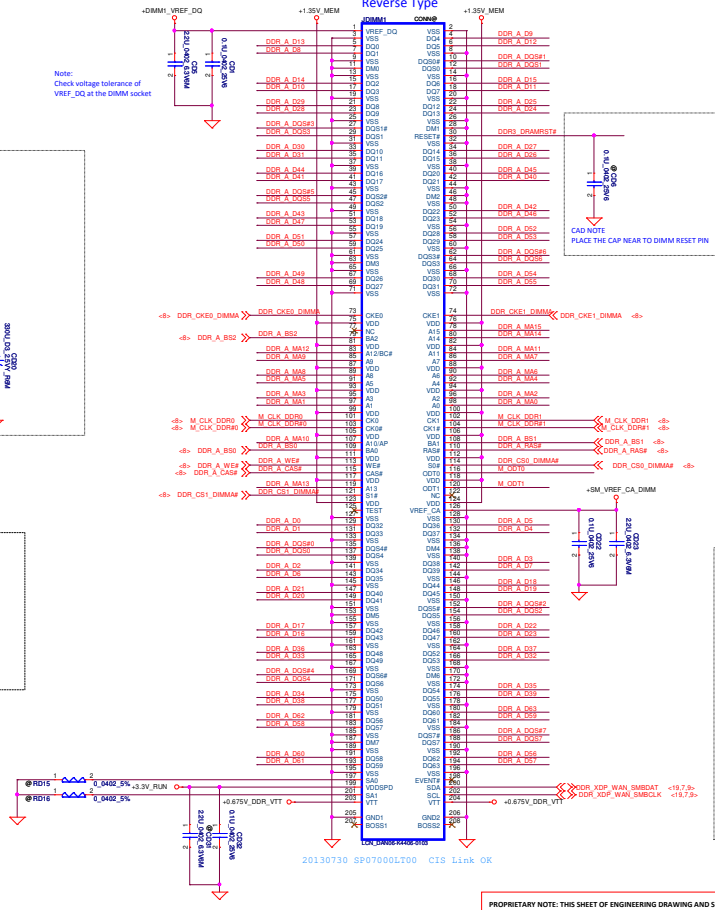

DDR3_DRAMRST# CPU

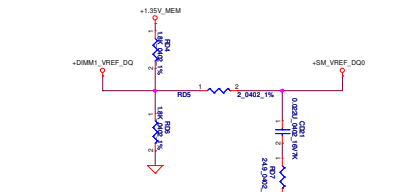

DDR3L SODIMM ODT GENERATION

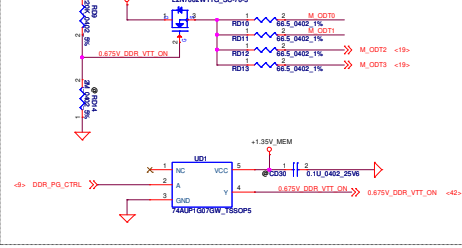

DELL CONFIDENTIAL/PROPRIETARY
Compaq Electronics, Inc.

PROPRIETARY NOTE: THIS SHEET OF ENGINEERING DRAWING AND SPECIFICATIONS CONTAINS CONFIDENTIAL TRADE SECRET AND OTHER PROPRIETARY INFORMATION OF DELL INC. ("DELL") THIS DOCUMENT MAY NOT BE TRANSFERRED OR COPIED WITHOUT THE EXPRESS WRITTEN AUTHORIZATION OF DELL. IN ADDITION, NEITHER THIS SHEET NOR THE INFORMATION IT CONTAINS MAY BE USED BY OR DISCLOSED TO ANY THIRD PARTY WITHOUT DELL'S EXPRESS WRITTEN CONSENT.

LA-A972P
Rev 1.1
Date: 10/07/2014

+3.3V_HDD source

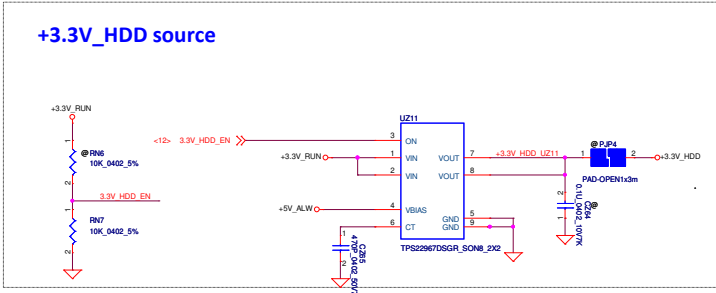

Mini mSATA H=4

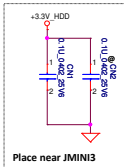
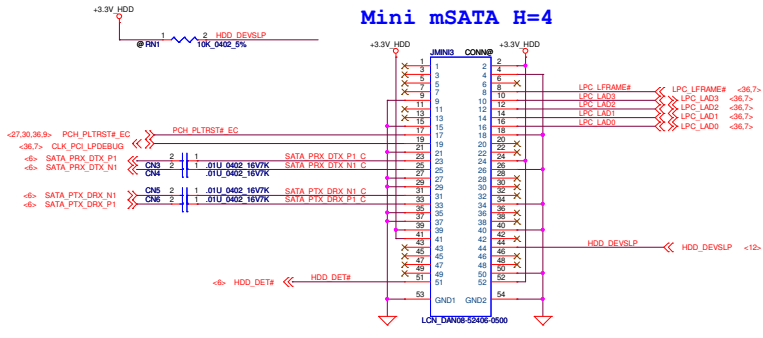

PROPRIETARY NOTE: THIS SHEET OF ENGINEERING DRAWING AND SPECIFICATIONS CONTAINS CONFIDENTIAL TRADE SECRET AND OTHER PROPRIETARY INFORMATION OF DELL INC. ("DELL") THIS DOCUMENT MAY NOT BE TRANSFERRED OR COPIED WITHOUT THE EXPRESS WRITTEN AUTHORIZATION OF DELL. IN ADDITION, NEITHER THIS SHEET NOR THE INFORMATION IT CONTAINS MAY BE USED BY OR DISCLOSED TO ANY THIRD PARTY WITHOUT DELL'S EXPRESS WRITTEN CONSENT.

DELL CONFIDENTIAL/PROPRIETARY

Compal Electronics, Inc.	
HDD CONN	
LA-A972P	Rev 0.1
Date: Monday, March 17, 2014	Sheet 20 of 25



1W x 1oh, 4ohm (Transformer spec is 8ohm) 500mV per unit, there are two transducer units in one speaker box)

Internal Speakers Header

40 mils trace Keep 20 mils spacing

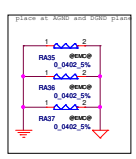
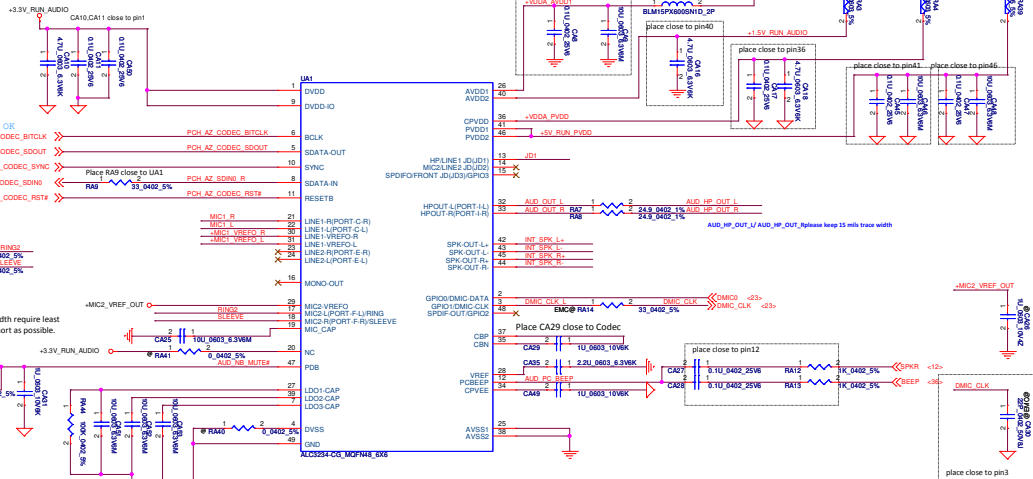
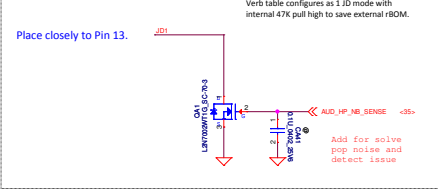
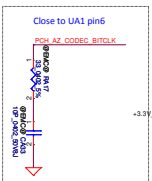
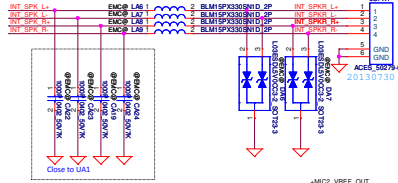

Realtek feedback
Prevent the Noise from Combo Jack
while system entry into S3 / S4 / S5

PROPRIETARY NOTE: THIS SHEET OF ENGINEERING DRAWING AND SPECIFICATIONS CONTAINS CONFIDENTIAL TRADE SECRET AND OTHER PROPRIETARY INFORMATION OF DELL INC. ("DELL") THIS DOCUMENT MAY NOT BE TRANSFERRED OR COPIED WITHOUT THE EXPRESS WRITTEN AUTHORIZATION OF DELL IN ADDITION, NEITHER THIS SHEET NOR THE INFORMATION IT CONTAINS MAY BE USED BY OR DISCLOSED TO ANY THIRD PARTY WITHOUT DELL'S EXPRESS WRITTEN CONSENT.

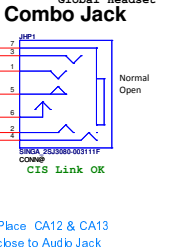
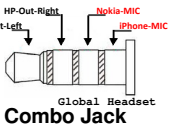

DELL CONFIDENTIAL/PROPRIETARY

Compal Electronics, Inc.

Doc: LA-A972P

Rev: 1.1

Date: Monday, March 17, 2014

PROPRIETARY NOTE: THIS SHEET OF ENGINEERING DRAWING AND SPECIFICATIONS CONTAINS CONFIDENTIAL TRADE SECRET AND OTHER PROPRIETARY INFORMATION OF DELL INC. ("DELL") THIS DOCUMENT MAY NOT BE TRANSMITTED OR COPIED WITHOUT THE EXPRESS WRITTEN AUTHORIZATION OF DELL. IN ADDITION, NEITHER THIS SHEET NOR THE INFORMATION IT CONTAINS MAY BE USED BY OR DISCLOSED TO ANY THIRD PARTY WITHOUT DELL'S EXPRESS WRITTEN CONSENT.

DELL CONFIDENTIAL/PROPRIETARY			
 Compal Electronics, Inc.			
DP 1.2 MST HUB			
Doc	Document Number	Rev	
	LA-A972P	0.1	
Date	Monday, March 17, 2014	Sheet	22 of 48

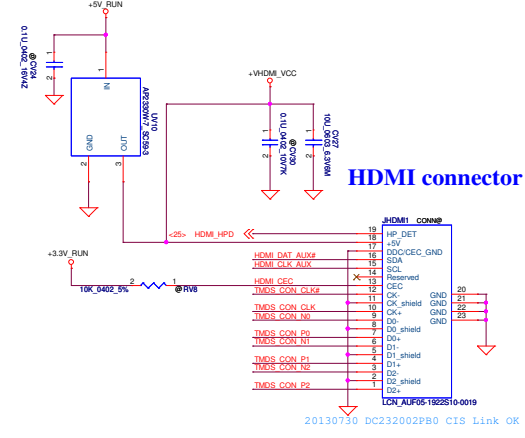
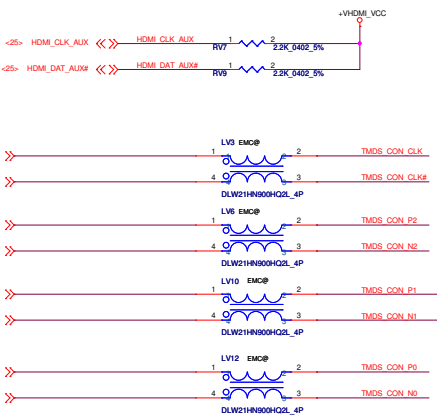

20130730 DC232002P80 CIS Link OK
 LCN_AU051922510-0019

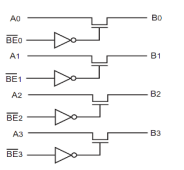

AUX/DDC SW for DDI2 to Mini DP

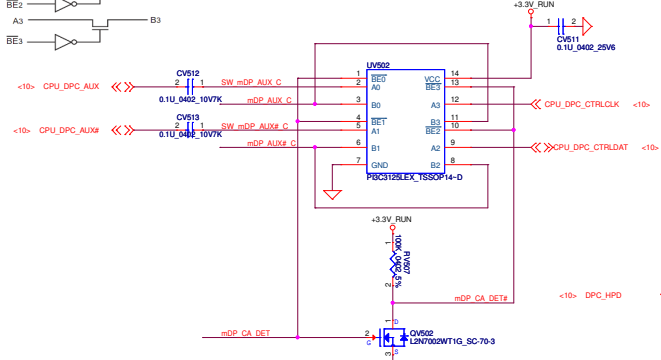

mDP_CA_DET	Function
1	mDP
0	BIOS

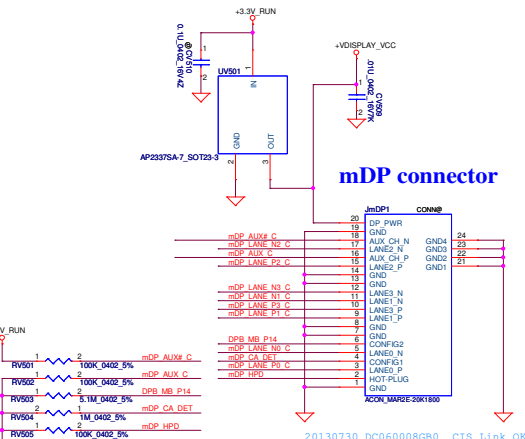
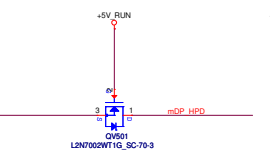
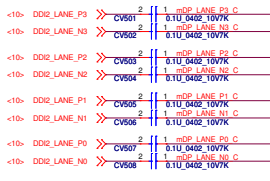

20130730 DC060008G80 CIS Link OK
 ACOM_MAREE20K1800

PROPRIETARY NOTE: THIS SHEET OF ENGINEERING DRAWING AND SPECIFICATIONS CONTAINS CONFIDENTIAL TRADE SECRET AND OTHER PROPRIETARY INFORMATION OF DELL INC. ("DELL") THIS DOCUMENT MAY NOT BE TRANSFERRED OR COPIED WITHOUT THE EXPRESS WRITTEN AUTHORIZATION OF DELL. IN ADDITION, NEITHER THIS SHEET NOR THE INFORMATION IT CONTAINS MAY BE USED BY OR DISCLOSED TO ANY THIRD PARTY WITHOUT DELL'S EXPRESS WRITTEN CONSENT.

DELL CONFIDENTIAL/PROPRIETARY

Compal Electronics, Inc.

HDMI CONN

Doc Number: LA-A972P

Date: Monday, March 17, 2014

Sheet: 24 of 48

Rev: 0.1

PCB	DP SWITCH
G12 UMA	PS8339+PS8338
G12 Entry	PS8339
G14 DSC	PS8339+PS8338
G14 UMA	PS8339
G14D_En	PS8339+PS8338
G14U_En	PS8339

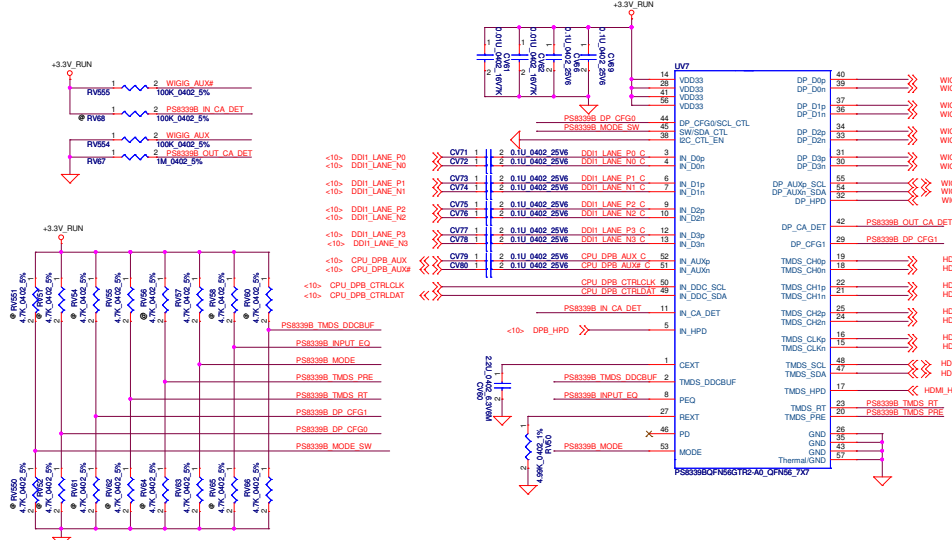

- MODE = L: Control Switching Mode, HDMI ID disable
= H: Automatic Switching Mode, HDMI ID disable
= M: Automatic Switching Mode, HDMI ID enable
- TMDS_PRE = L: no pre-emphasis
= H: 1.5dB pre-emphasis
= M: 3.0dB pre-emphasis
- TMDS_RT = L: Standard open drain driver
= H: Open drain driver with termination resistors
- TMDS_DDCBUF = L: DDC pass through
= H: DDC active buffer
= M: DDC pass through with 40 kohm pull up resistor
- PEQ = L: default, LEQ, compensate channel loss up to 12dB @ HBR2
= H: HEQ, compensate channel loss up to 15dB @ HBR2
= M: LLEQ, compensate channel loss up to 5dB @ HBR2
- DP_CFG1 = L: default, auto test disable & input offset cancellation enable
= H: auto test enable & input offset cancellation enable
= M: auto test disable & input offset cancellation disable
- DP_CFG0 = L: default, automatic EQ enable & AUX interception enable
= H: automatic EQ disable & AUX interception enable
= M: automatic EQ disable & AUX interception disable, no pre-emphasis, 800mVpp swing

DELL CONFIDENTIAL/PROPRIETARY

Compal Electronics, Inc.	
DP SW	
Doc Number	Rev
LA-A972P	0.1
Date	Sheet
Monday, March 17, 2014	25 of 48

PROPRIETARY NOTE: THIS SHEET OF ENGINEERING DRAWING AND SPECIFICATIONS CONTAINS CONFIDENTIAL TRADE SECRET AND OTHER PROPRIETARY INFORMATION OF DELL INC. ("DELL") THIS DOCUMENT MAY NOT BE TRANSFERRED OR COPIED WITHOUT THE EXPRESS WRITTEN AUTHORIZATION OF DELL. IN ADDITION, NEITHER THIS SHEET NOR THE INFORMATION IT CONTAINS MAY BE USED BY OR DISCLOSED TO ANY THIRD PARTY WITHOUT DELL'S EXPRESS WRITTEN CONSENT.

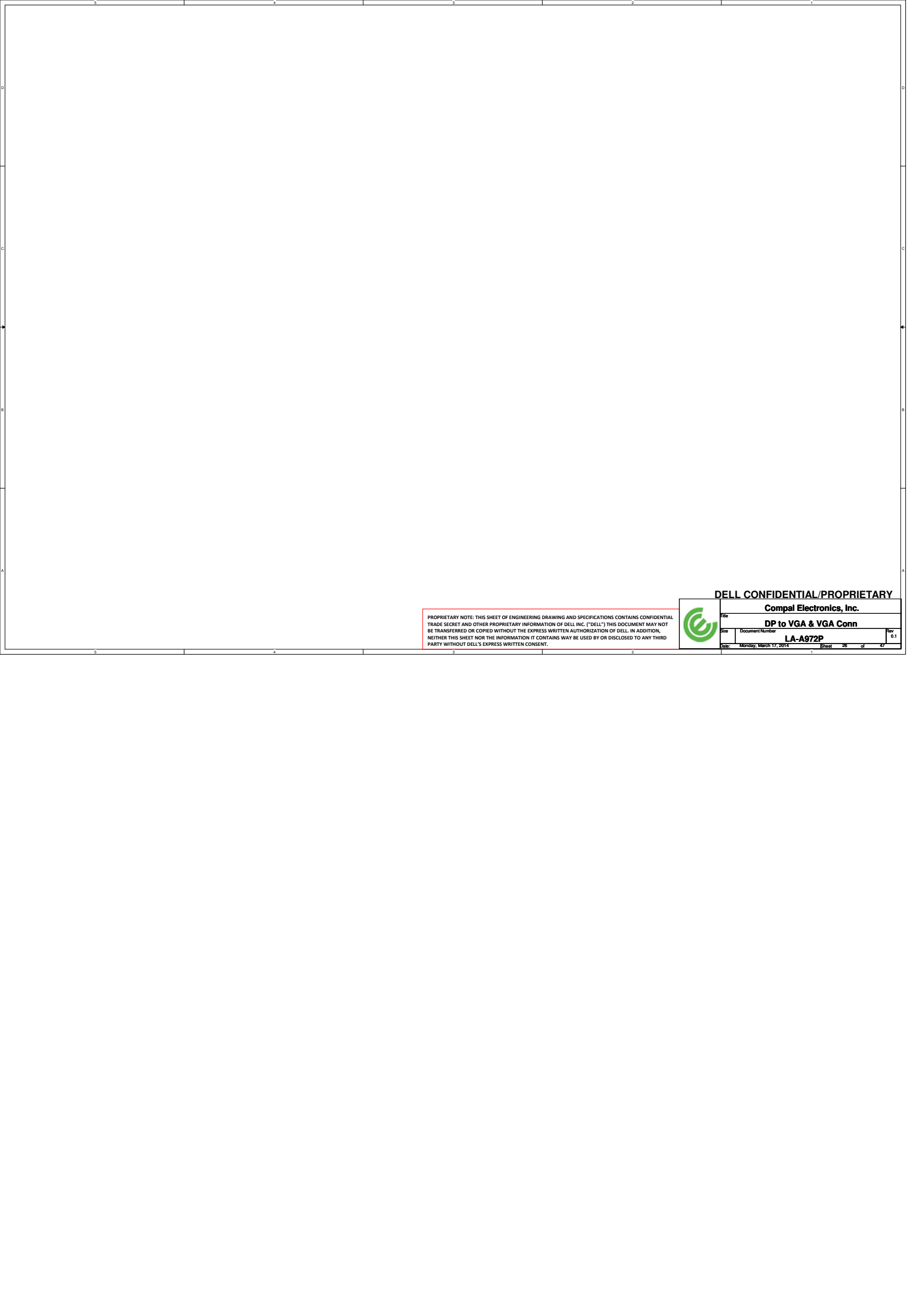

PROPRIETARY NOTE: THIS SHEET OF ENGINEERING DRAWING AND SPECIFICATIONS CONTAINS CONFIDENTIAL TRADE SECRET AND OTHER PROPRIETARY INFORMATION OF DELL INC. ("DELL") THIS DOCUMENT MAY NOT BE TRANSFERRED OR COPIED WITHOUT THE EXPRESS WRITTEN AUTHORIZATION OF DELL. IN ADDITION, NEITHER THIS SHEET NOR THE INFORMATION IT CONTAINS MAY BE USED BY OR DISCLOSED TO ANY THIRD PARTY WITHOUT DELL'S EXPRESS WRITTEN CONSENT.

DELL CONFIDENTIAL/PROPRIETARY



Compal Electronics, Inc.		
DP to VGA & VGA Conn		
Size	Document Number	Rev
	LA-A972P	0.1
Date	Monday, March 17, 2014	Sheet 25 of 47

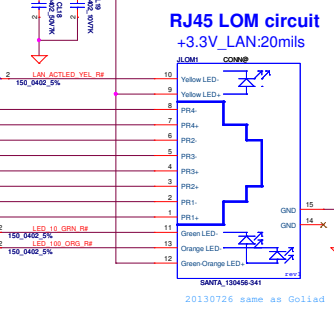
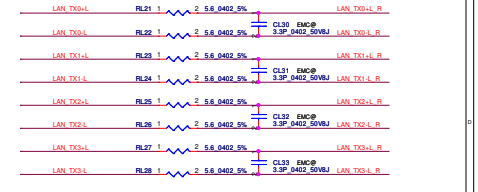
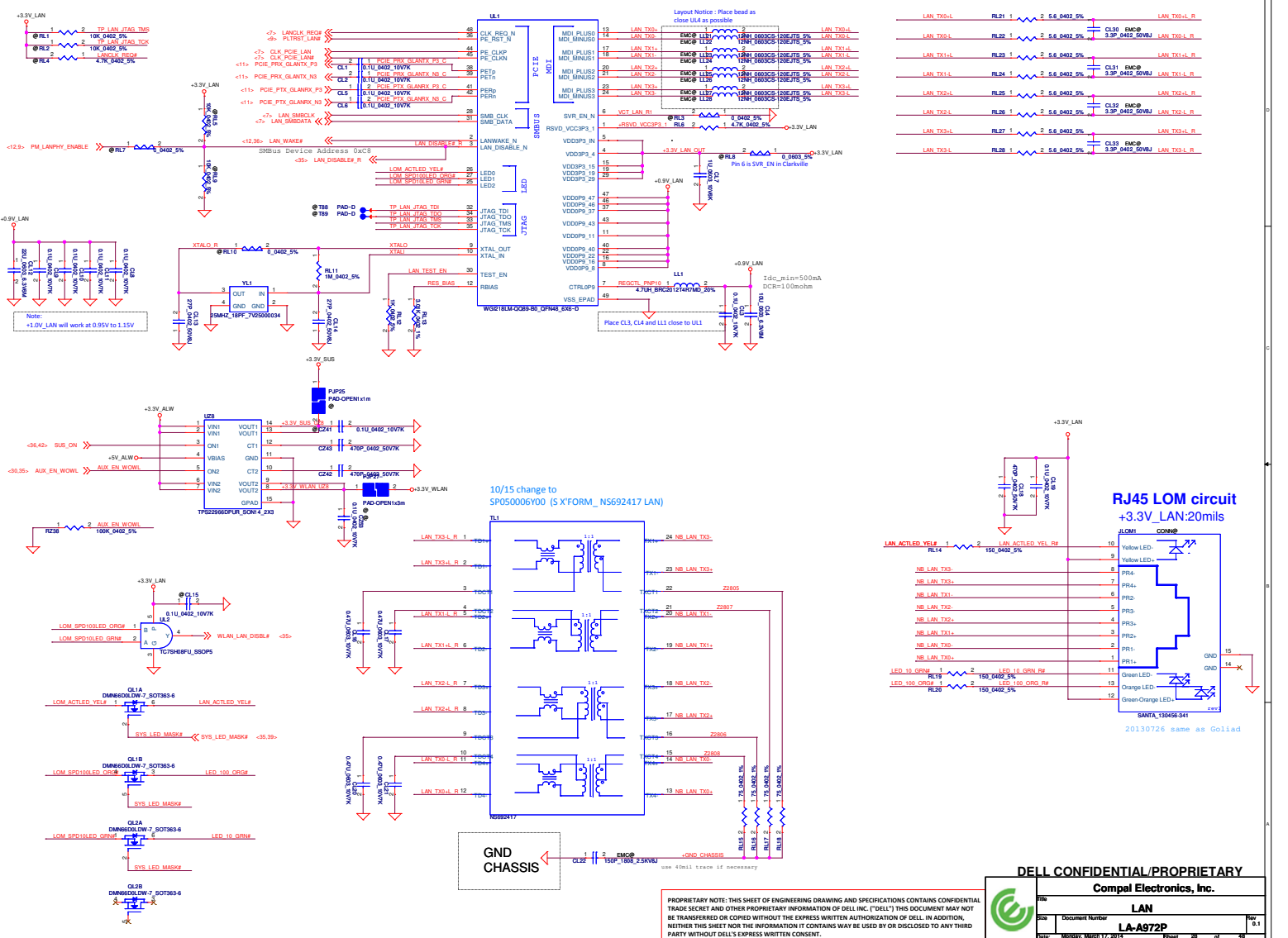

DELL CONFIDENTIAL/PROPRIETARY
Compal Electronics, Inc.

File: **LAN**
 Doc: Document Number: **LA-A972P**
 Date: Monday, March 17, 2014

PROPRIETARY NOTE: THIS SHEET OF ENGINEERING DRAWING AND SPECIFICATIONS CONTAINS CONFIDENTIAL TRADE SECRET AND OTHER PROPRIETARY INFORMATION OF DELL INC. ("DELL"). THIS DOCUMENT MAY NOT BE TRANSFERRED OR COPIED WITHOUT THE EXPRESS WRITTEN AUTHORIZATION OF DELL. IN ADDITION, NEITHER THIS SHEET NOR THE INFORMATION IT CONTAINS MAY BE USED BY OR DISCLOSED TO ANY THIRD PARTY WITHOUT DELL'S EXPRESS WRITTEN CONSENT.

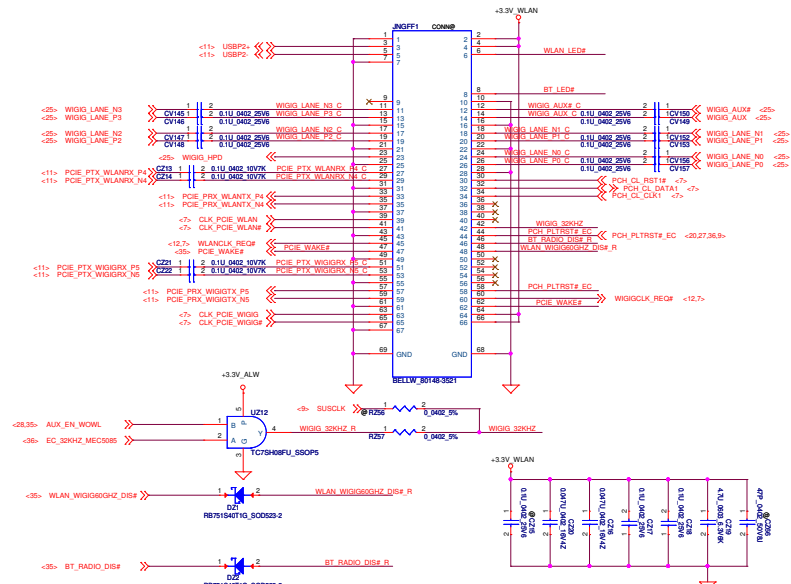

STATE #	CONFIG_0	CONFIG_1	CONFIG_2	CONFIG_3	Module Type
0	GND	GND	GND	GND	SSD-SATA
1	GND	HIGH	GND	GND	SSD-PCI-E
8	HIGH	GND	GND	GND	WWAN
14	HIGH	GND	HIGH	HIGH	HCA-PCI-E
15	HIGH	HIGH	HIGH	HIGH	NA

Power Rating TBD

PWR Rail	Voltage Tolerance	Primary Power		Aux Power
		Peak	Normal	Normal
+3.3V				

LED control circuit

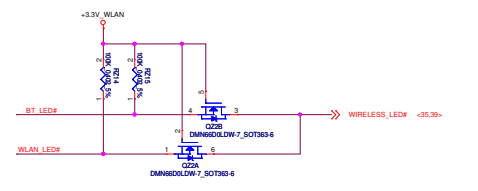
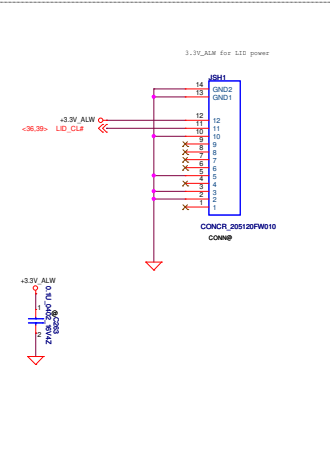

PROPRIETARY NOTE: THIS SHEET OF ENGINEERING DRAWING AND SPECIFICATIONS CONTAINS CONFIDENTIAL TRADE SECRET AND OTHER PROPRIETARY INFORMATION OF DELL INC. ("DELL") THIS DOCUMENT MAY NOT BE TRANSFERRED OR COPIED WITHOUT THE EXPRESS WRITTEN AUTHORIZATION OF DELL. IN ADDITION, NEITHER THIS SHEET NOR THE INFORMATION IT CONTAINS MAY BE USED BY OR DISCLOSED TO ANY THIRD PARTY WITHOUT DELL'S EXPRESS WRITTEN CONSENT.

DELL CONFIDENTIAL/PROPRIETARY

Compal Electronics, Inc.

NGFF Card

LA-A972P

Doc Number

Doc: Monday, March 17, 2014

Page: 30 of 40

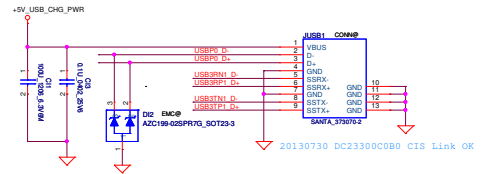
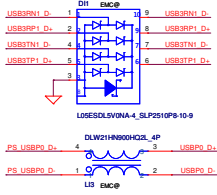
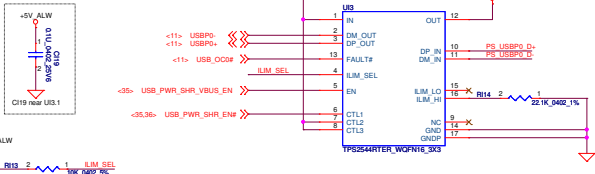
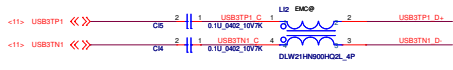

PCB	USB2 0	USB2 3
G12 UMA	USB3102	NX3DV221
G12 Entry	NA	NA
G14 DSC	USB3102	NX3DV221
G14 UMA	USB3102	NX3DV221
G14D_En	NA	NA
G14U_En	NA	NA

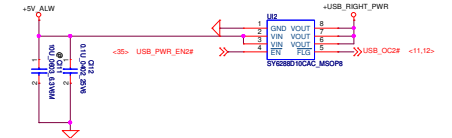
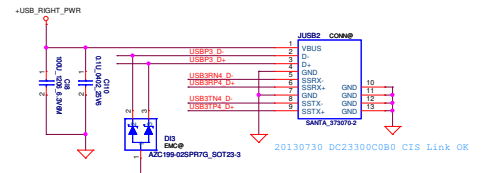
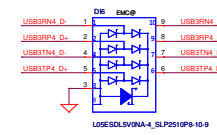
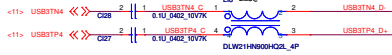
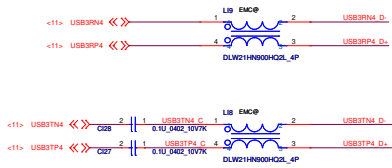

DELL CONFIDENTIAL/PROPRIETARY

Compal Electronics, Inc.

PROPRIETARY NOTE: THIS SHEET OF ENGINEERING DRAWING AND SPECIFICATIONS CONTAINS CONFIDENTIAL TRADE SECRET AND OTHER PROPRIETARY INFORMATION OF DELL INC. ("DELL") THIS DOCUMENT MAY NOT BE TRANSFERRED OR COPIED WITHOUT THE EXPRESS WRITTEN AUTHORIZATION OF DELL IN ADDITION, NEITHER THIS SHEET NOR THE INFORMATION IT CONTAINS MAY BE USED BY OR DISCLOSED TO ANY THIRD PARTY WITHOUT DELL'S EXPRESS WRITTEN CONSENT.

USB3.0		Rev
Size	Document Number	01
Rev	LA-A972P	1
Rev	Monday, March 11, 2014	31 of 42

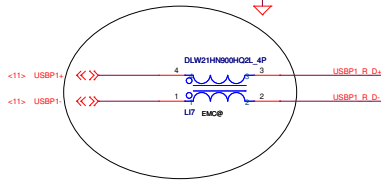
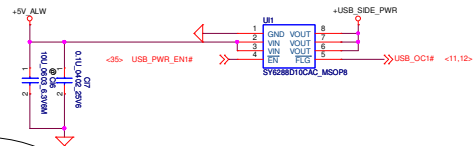
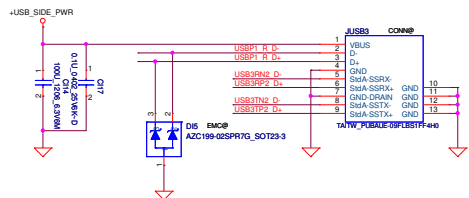
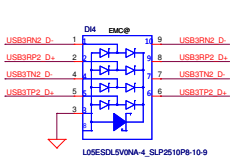
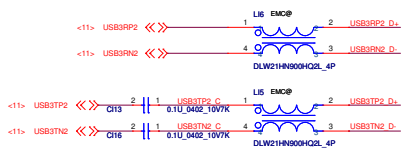

PROPRIETARY NOTE: THIS SHEET OF ENGINEERING DRAWING AND SPECIFICATIONS CONTAINS CONFIDENTIAL TRADE SECRET AND OTHER PROPRIETARY INFORMATION OF DELL INC. ("DELL") THIS DOCUMENT MAY NOT BE TRANSFERRED OR COPIED WITHOUT THE EXPRESS WRITTEN AUTHORIZATION OF DELL. IN ADDITION, NEITHER THIS SHEET NOR THE INFORMATION IT CONTAINS MAY BE USED BY OR DISCLOSED TO ANY THIRD PARTY WITHOUT DELL'S EXPRESS WRITTEN CONSENT.

DELL CONFIDENTIAL/PROPRIETARY

Compal Electronics, Inc.

USB SW		Rev 0.1
File	Document Number	
LA-A972P		
Date	Monday, March 17, 2014	Sheet 32 of 45

NFC on USH/B

PROPRIETARY NOTE: THIS SHEET OF ENGINEERING DRAWING AND SPECIFICATIONS CONTAINS CONFIDENTIAL TRADE SECRET AND OTHER PROPRIETARY INFORMATION OF DELL INC. ("DELL") THIS DOCUMENT MAY NOT BE TRANSFERRED OR COPIED WITHOUT THE EXPRESS WRITTEN AUTHORIZATION OF DELL. IN ADDITION, NEITHER THIS SHEET NOR THE INFORMATION IT CONTAINS MAY BE USED BY OR DISCLOSED TO ANY THIRD PARTY WITHOUT DELL'S EXPRESS WRITTEN CONSENT.

DELL CONFIDENTIAL/PROPRIETARY
Compal Electronics, Inc.

	File	NFC	
	Size	Document Number	Rev
		LA-A972P	0.1
	Date	Monday, March 17, 2014	Sheet 33 of 48

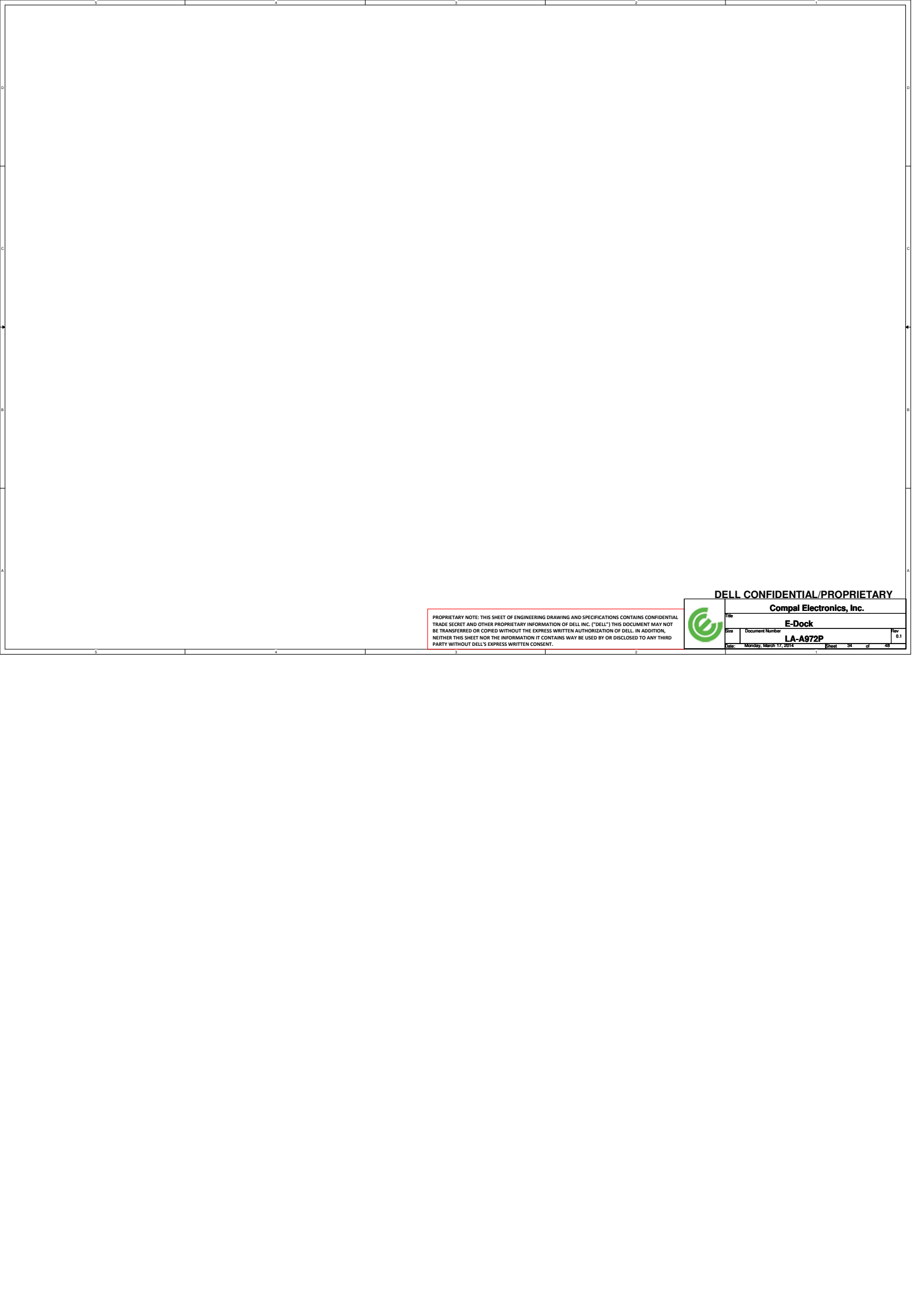

PROPRIETARY NOTE: THIS SHEET OF ENGINEERING DRAWING AND SPECIFICATIONS CONTAINS CONFIDENTIAL TRADE SECRET AND OTHER PROPRIETARY INFORMATION OF DELL INC. ("DELL") THIS DOCUMENT MAY NOT BE TRANSFERRED OR COPIED WITHOUT THE EXPRESS WRITTEN AUTHORIZATION OF DELL. IN ADDITION, NEITHER THIS SHEET NOR THE INFORMATION IT CONTAINS MAY BE USED BY OR DISCLOSED TO ANY THIRD PARTY WITHOUT DELL'S EXPRESS WRITTEN CONSENT.



DELL CONFIDENTIAL/PROPRIETARY

Compal Electronics, Inc.

Title	E-Dock		Rev	0.1
Doc	Document Number	LA-A972P		
Date	Monday, March 17, 2014	Sheet	34	of 48

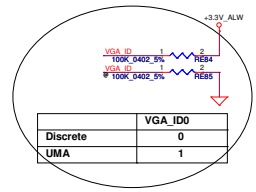
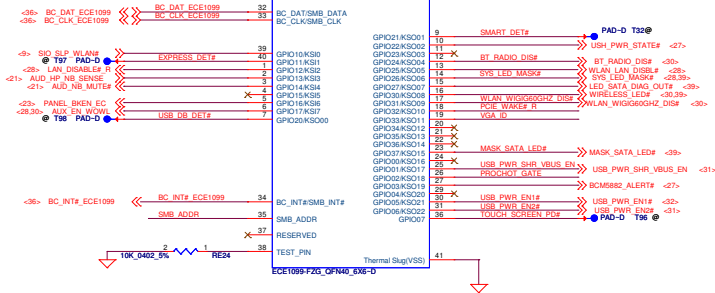
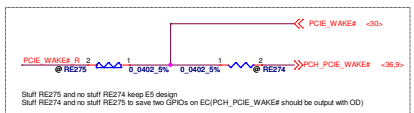
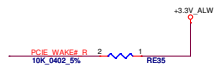
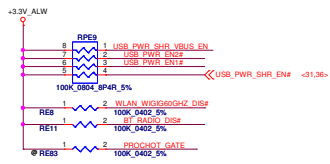

	VGA_ID0
Discrete	0
UMA	1

PROPRIETARY NOTE: THIS SHEET OF ENGINEERING DRAWING AND SPECIFICATIONS CONTAINS CONFIDENTIAL TRADE SECRET AND OTHER PROPRIETARY INFORMATION OF DELL INC. ("DELL") THIS DOCUMENT MAY NOT BE TRANSFERRED OR COPIED WITHOUT THE EXPRESS WRITTEN AUTHORIZATION OF DELL. IN ADDITION, NEITHER THIS SHEET NOR THE INFORMATION IT CONTAINS MAY BE USED BY OR DISCLOSED TO ANY THIRD PARTY WITHOUT DELL'S EXPRESS WRITTEN CONSENT.

DELL CONFIDENTIAL/PROPRIETARY
Compal Electronics, Inc.

File	ECE5048	
Size	Document Number	Rev
	LA-A972P	0.1
Date	Monday, March 17, 2014	Sheet 35 of 47

Touch Pad

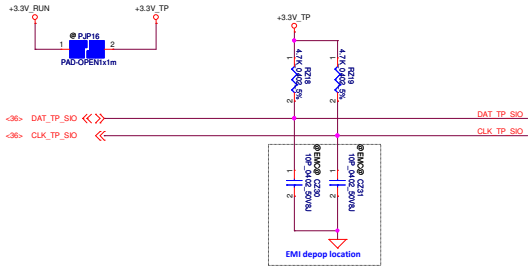

Keyboard

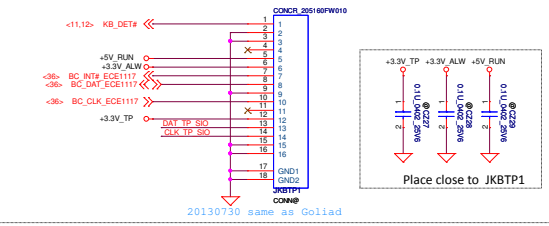

RSMRST circuit

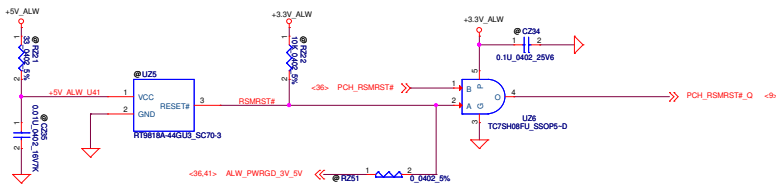

@P Cable

Part Number	Description
DCS1057P00	8-CMM SET 14A MB-ESP-LED-CAMERA

@P TS Cable

Part Number	Description
DCS2007G00	8-CMM SET 14A MB-ESP-LED-CAMERA-TS

@DC-IN Cable

Part Number	Description
DC30100MFD0	CMM SET 0VN DC3ACR-MB 22W1003-038110P

@RTC BATT

Part Number	Description
DC30100MFD0	CMM SET 0VN DC3ACR-MB 22W1003-038110P

@FAN

Part Number	Description
DC28A005800	FAN SET DAQ25 DC5V AB74058B-MB3 A20A

@USH Board FFC

Part Number	Description
HBK00018200	FFC 50P G P0.5 PAD=0.3 4786 MB-USH

@VTP FFC

Part Number	Description
HBK00018200	FFC 50P G P0.5 PAD=0.3 4786 MB-USH

@NFC Board FFC

Part Number	Description
HBK00018200	FFC 50P G P0.5 PAD=0.3 4786 MB-USH

@FP FFC

Part Number	Description
HBK00018200	FFC 50P F P0.5 PAD=0.3 4786 MB-FP

@SM-HMB FFC

Part Number	Description
HBK00018200	FFC 50P G P0.5 PAD=0.3 4786 MB-FP

@Spk

Part Number	Description
PK230053Q01	SPK PACK 2.5X 2.0X 4 OHM PD

PROPRIETARY NOTE: THIS SHEET OF ENGINEERING DRAWING AND SPECIFICATIONS CONTAINS CONFIDENTIAL TRADE SECRET AND OTHER PROPRIETARY INFORMATION OF DELL INC. ("DELL"). THIS DOCUMENT MAY NOT BE TRANSFERRED OR COPIED WITHOUT THE EXPRESS WRITTEN AUTHORIZATION OF DELL. IN ADDITION, NEITHER THIS SHEET NOR THE INFORMATION IT CONTAINS MAY BE USED BY OR DISCLOSED TO ANY THIRD PARTY WITHOUT DELL'S EXPRESS WRITTEN CONSENT.

DELL CONFIDENTIAL/PROPRIETARY



Compal Electronics, Inc.	
File	Keyboard
Size	Document Number LA-A972P
Date	Monday, March 17, 2014 Sheet 3/ of 48

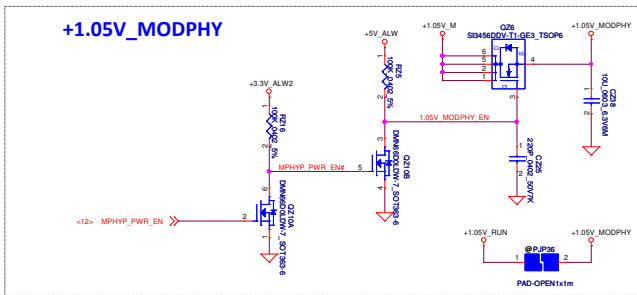

if support MODPHY off keep DSC solution
MODPHY timing spec 0.7V/us and <65us

Figure 5-6. Sequencing Requirements between HSIOPC and LPT-LP 1.05V rails and COMP/IREF signals

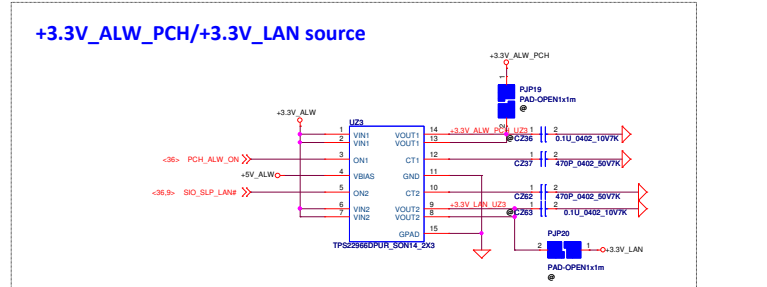
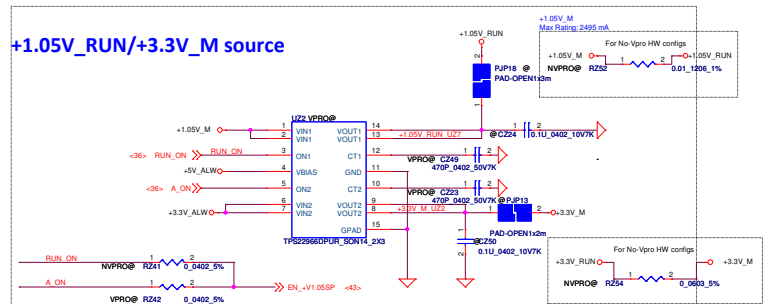
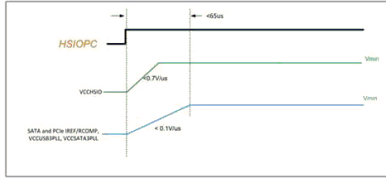

HDD LED solution for White LED

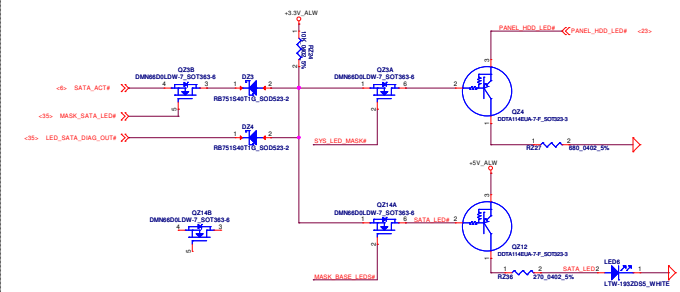

Battery LED

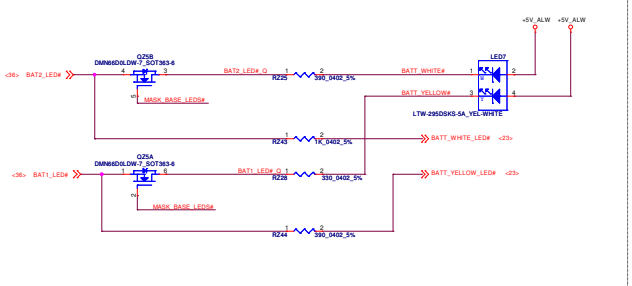

WLAN LED solution for White LED

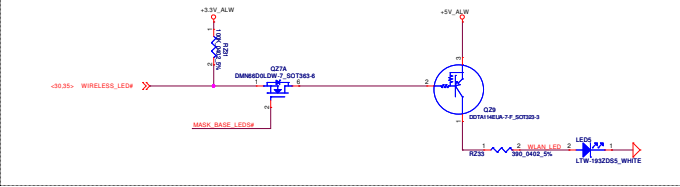

Breath LED

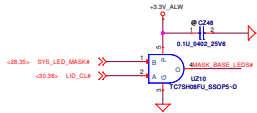
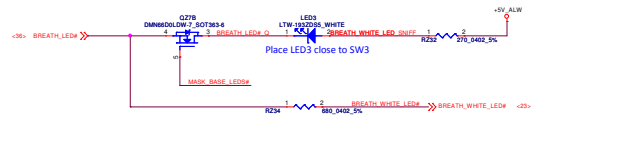

POWER & INSTANT ON SWITCH

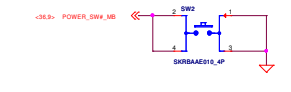

	SYS_LED_MASK#	LID_CL#
Mask All LEDs (Sniffer Function)	0	X
Mask Base MB LEDs (Lid Closed)	1	0
Do not Mask LEDs (Lid Opened)	1	1

- Fiducial Mark**
- ⊙ F01
 - ⊗ F02
 - ⊙ F03
 - ⊗ F04

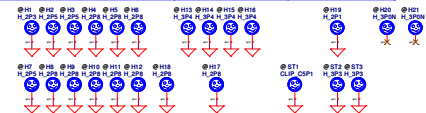

PROPRIETARY NOTE: THIS SHEET OF ENGINEERING DRAWING AND SPECIFICATIONS CONTAINS CONFIDENTIAL TRADE SECRET AND OTHER PROPRIETARY INFORMATION OF DELL INC. ("DELL") THIS DOCUMENT MAY NOT BE TRANSMITTED OR COPIED WITHOUT THE EXPRESS WRITTEN AUTHORIZATION OF DELL. IN ADDITION, NEITHER THIS SHEET NOR THE INFORMATION IT CONTAINS MAY BE USED BY OR DISCLOSED TO ANY THIRD PARTY WITHOUT DELL'S EXPRESS WRITTEN CONSENT.

DELL CONFIDENTIAL/PROPRIETARY

Compal Electronics, Inc.

PAD_LED

Doc# Document Number: **LA-A972P**

Date: Monday, March 17, 2014

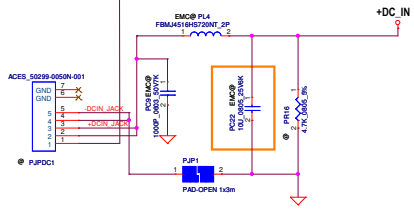
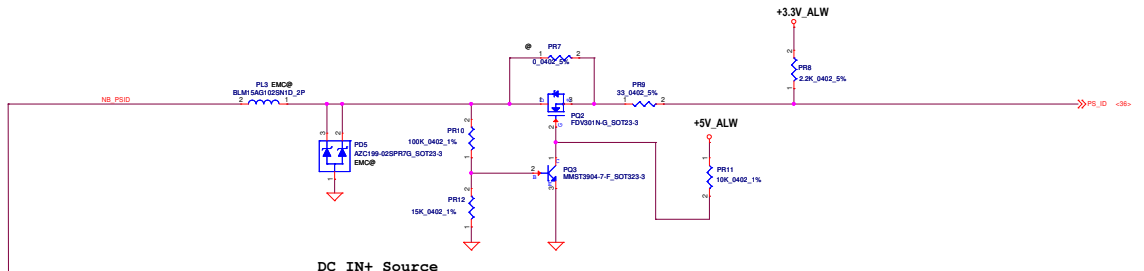
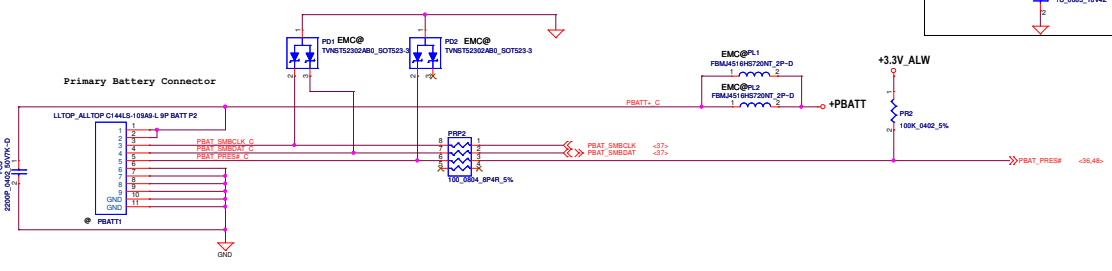
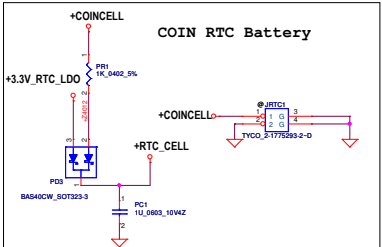

DELL CONFIDENTIAL/PROPRIETARY

THIS SHEET OF ENGINEERING DRAWING IS THE PROPRIETARY PROPERTY OF COMPAL ELECTRONICS, INC. AND CONTAINS CONFIDENTIAL AND TRADE SECRET INFORMATION. THIS SHEET MAY NOT BE TRANSFERRED FROM THE CUSTODY OF THE COMPETENT DIVISION OR DEPARTMENT EXCEPT AS AUTHORIZED BY COMPAL ELECTRONICS, INC. NEITHER THIS SHEET NOR THE INFORMATION IT CONTAINS MAY BE USED BY OR DISCLOSED TO ANY THIRD PARTY WITHOUT PRIOR WRITTEN CONSENT OF COMPAL ELECTRONICS, INC.

		Compal Electronics, Inc.	
		+DCIN	
Doc No	Document Number	LA-A902P	
Rev	Revision	41	0.1

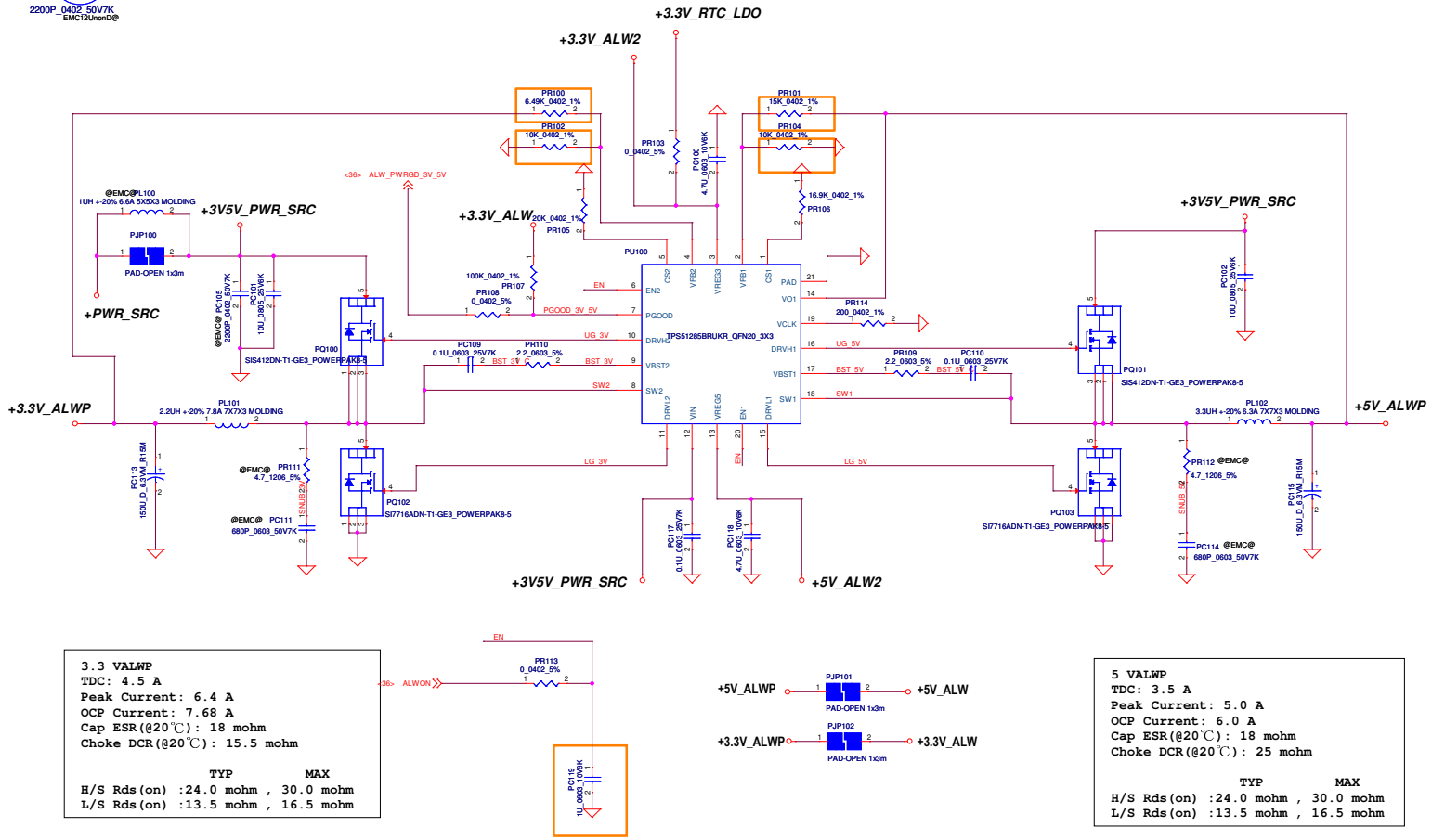

3.3 VALWP
TDC: 4.5 A
Peak Current: 6.4 A
OCP Current: 7.68 A
Cap ESR (@20°C): 18 mohm
Choke DCR (@20°C): 15.5 mohm

	TYP	MAX
H/S Rds (on)	:24.0 mohm	30.0 mohm
L/S Rds (on)	:13.5 mohm	16.5 mohm

5 VALWP
TDC: 3.5 A
Peak Current: 5.0 A
OCP Current: 6.0 A
Cap ESR (@20°C): 18 mohm
Choke DCR (@20°C): 25 mohm

	TYP	MAX
H/S Rds (on)	:24.0 mohm	30.0 mohm
L/S Rds (on)	:13.5 mohm	16.5 mohm

THIS SHEET OF ENGINEERING DRAWING IS THE PROPRIETARY PROPERTY OF COMPAL ELECTRONICS, INC. AND CONTAINS AND TRADE SECRET INFORMATION. THIS SHEET MAY NOT BE TRANSFERRED FROM THE CUSTODY OF THE COMPETENT DIVISION DEPARTMENT EXCEPT AS AUTHORIZED BY COMPAL ELECTRONICS, INC. NEITHER THIS SHEET NOR THE INFORMATION IT CONTAINS MAY BE USED BY OR DISCLOSED TO ANY THIRD PARTY WITHOUT PRIOR WRITTEN CONSENT OF COMPAL ELECTRONICS, INC.

Compal Electronics, Inc.		
Title	+5V_ALW/3.3V_ALW	
Size	Document Number	Rev
	LA-A902P	0.1
Date	Monday, March 17, 2014	Sheet 41 of 47

0.675 Volt
 TDC 0.7 A
 Peak Current 1.0 A
 OCP Current 2.6 A

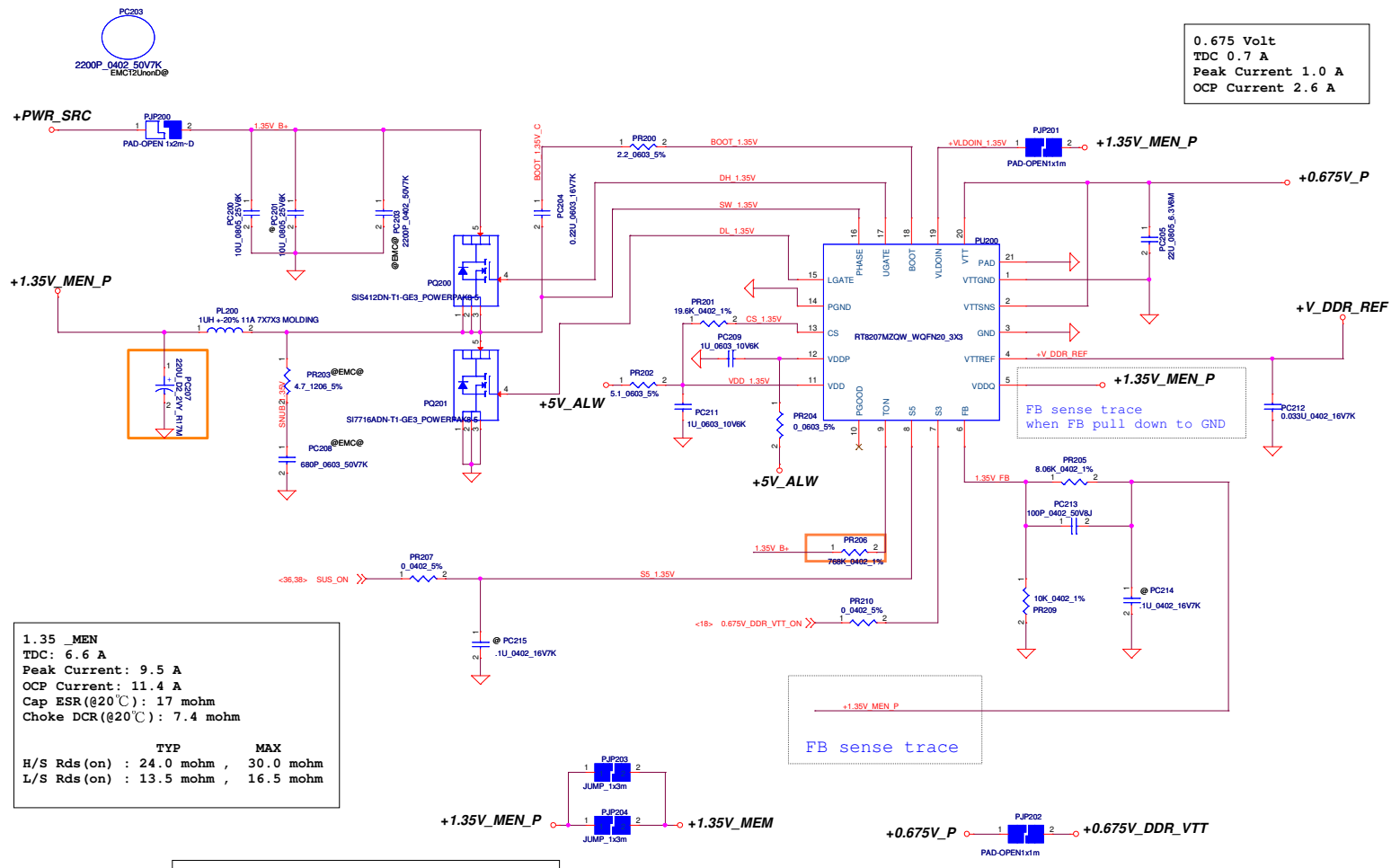

1.35_MEN
 TDC: 6.6 A
 Peak Current: 9.5 A
 OCP Current: 11.4 A
 Cap ESR (@20°C): 17 mohm
 Choke DCR (@20°C): 7.4 mohm

TYP MAX
 H/S Rds (on) : 24.0 mohm , 30.0 mohm
 L/S Rds (on) : 13.5 mohm , 16.5 mohm

Mode	S3	S5	+1.35V_MEN	+V_DDR_REF	+0.675V_P
S5	L	L	off	off	off
S3	L	H	on	on	off (Hi-Z)
S0	H	H	on	on	on

THIS SHEET OF ENGINEERING DRAWING IS THE PROPRIETARY PROPERTY OF COMPAL ELECTRONICS, INC. AND CONTAINS TRADE SECRET INFORMATION. THIS SHEET MAY NOT BE TRANSFERRED FROM THE CUSTODY OF THE COMPETENT DIVISION OR DEPARTMENT EXCEPT AS AUTHORIZED BY COMPAL ELECTRONICS, INC. NEITHER THIS SHEET NOR THE INFORMATION IT CONTAINS MAY BE USED BY OR DISCLOSED TO ANY THIRD PARTY WITHOUT PRIOR WRITTEN CONSENT OF COMPAL ELECTRONICS, INC.

DELL CONFIDENTIAL/PROPRIETARY

Compal Electronics, Inc.			
File	+1.35V_MEN+0.675V_DDR_VTT		
Size	Document Number	LA-A902P	
Date	Monday, March 17, 2014	Sheet	42 of 47

+1.05V_MEN
 TDC: 5.7 A
 Peak Current: 8.1 A
 OCP Current: 9.7 A fix by IC
 Choke DCR(@20°C): 14.0 mohm

PC300
 2200P_0402_50V7K
 EMC12UhorD@

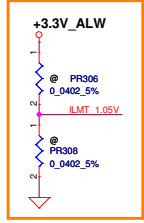
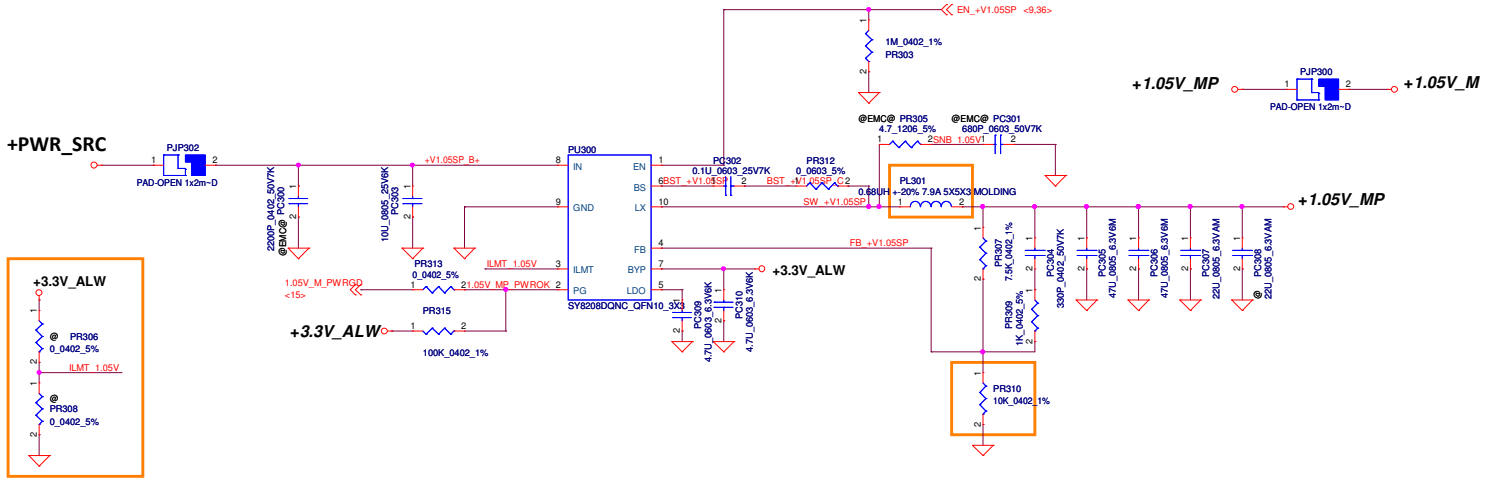

DELL CONFIDENTIAL/PROPRIETARY

THIS SHEET OF ENGINEERING DRAWING IS THE PROPRIETARY PROPERTY OF COMPAL ELECTRONICS, INC. AND CONTAINS CONFIDENTIAL AND TRADE SECRET INFORMATION. THIS SHEET MAY NOT BE TRANSFERRED FROM THE CUSTODY OF THE COMPETENT DIVISION OR DEPARTMENT EXCEPT AS AUTHORIZED BY COMPAL ELECTRONICS, INC. NEITHER THIS SHEET NOR THE INFORMATION IT CONTAINS MAY BE USED BY OR DISCLOSED TO ANY THIRD PARTY WITHOUT PRIOR WRITTEN CONSENT OF COMPAL ELECTRONICS, INC.

Compal Electronics, Inc.		
File	+1.05V_M	
Size	Document Number	Rev
	LA-A902P	0.1
Date:	Monday, March 17, 2014	Sheet 45 of 47

+1.5V_RUN
 TDC: 0.47 A
 Peak Current: 0.67 A

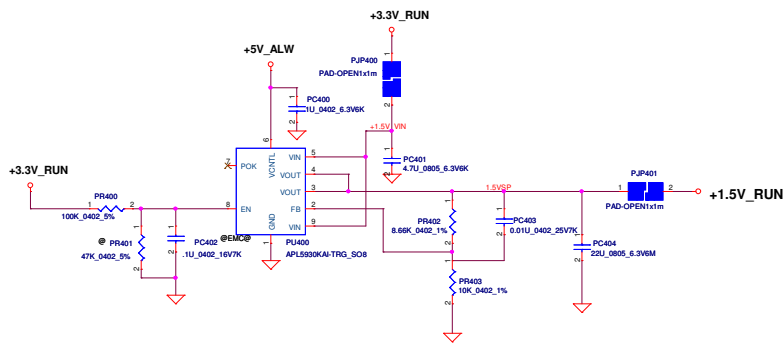

DELL CONFIDENTIAL/PROPRIETARY

Compal Electronics, Inc.

+1.5VSP

LA-A902P

Monday, March 17, 2014 Sheet 24 of 47

THIS SHEET OF ENGINEERING DRAWING IS THE PROPRIETARY PROPERTY OF COMPAL ELECTRONICS, INC. AND CONTAINS CONFIDENTIAL AND TRADE SECRET INFORMATION. THIS SHEET MAY NOT BE TRANSFERRED FROM THE CUSTODY OF THE COMPETENT DIVISION OR DEPARTMENT EXCEPT AS AUTHORIZED BY COMPAL ELECTRONICS, INC. NEITHER THIS SHEET NOR THE INFORMATION IT CONTAINS MAY BE USED BY OR DISCLOSED TO ANY THIRD PARTY WITHOUT PRIOR WRITTEN CONSENT OF COMPAL ELECTRONICS, INC.

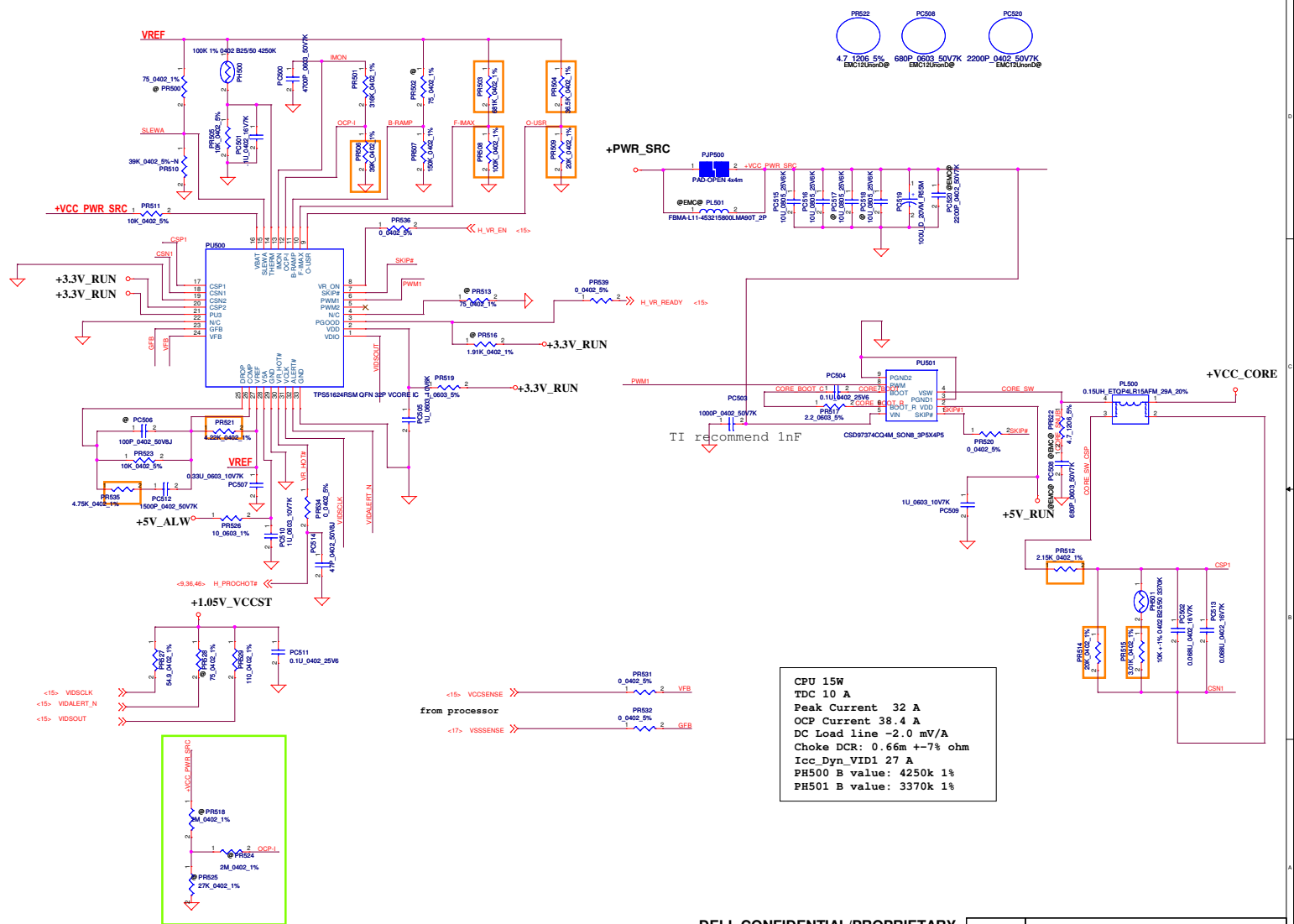

CPU 15W
 TDC 10 A
 Peak Current 32 A
 OCP Current 38.4 A
 DC Load line -2.0 mV/A
 Choke DCR: 0.66m +-7% ohm
 Icc_Dyn_VID1 27 A
 PH500 B value: 4250k 1%
 PH501 B value: 3370k 1%

DELL CONFIDENTIAL/PROPRIETARY



Compal Electronics, Inc.	
+VCC CORE	
Doc Number	LA-A902P
Date	Monday, March 17, 2014
Sheet	46 of 47
Rev	0.1

THIS SHEET OF ENGINEERING DRAWING IS THE PROPRIETARY PROPERTY OF COMPAL ELECTRONICS, INC. AND CONTAINS CONFIDENTIAL AND TRADE SECRET INFORMATION. THIS SHEET MAY NOT BE TRANSFERRED FROM THE CUSTODY OF THE COMPETENT DIVISION OR DEPARTMENT EXCEPT AS AUTHORIZED BY COMPAL ELECTRONICS, INC. NEITHER THIS SHEET NOR THE INFORMATION IT CONTAINS MAY BE USED BY OR DISCLOSED TO ANY THIRD PARTY WITHOUT PRIOR WRITTEN CONSENT OF COMPAL ELECTRONICS, INC.

Based on _RF Cheng. Hill
 鄭智仁 (11257) for PT 20131107

962

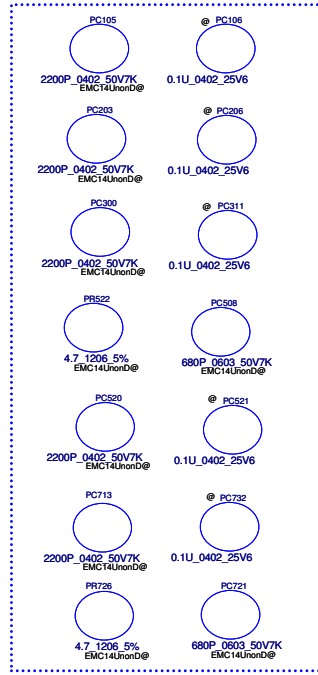
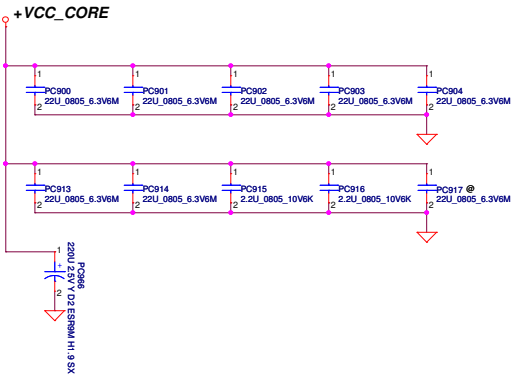

DELL CONFIDENTIAL/PROPRIETARY

THIS SHEET OF ENGINEERING DRAWING IS THE PROPRIETARY PROPERTY OF COMPAL ELECTRONICS, INC. AND CONTAINS TRADE SECRET INFORMATION. THIS SHEET MAY NOT BE TRANSFERRED FROM THE CUSTODY OF THE COMPETENT DIVISION OR DEPARTMENT EXCEPT AS AUTHORIZED BY COMPAL ELECTRONICS, INC. NEITHER THIS SHEET NOR THE INFORMATION IT CONTAINS MAY BE USED BY OR DISCLOSED TO ANY THIRD PARTY WITHOUT PRIOR WRITTEN CONSENT OF COMPAL ELECTRONICS, INC.

Compal Electronics, Inc.			
File	PROCESSOR DECOUPLING		
Size	Document Number	LA-A902P	
Date	Monday, March 17, 2014	Sheet	47 of 47

Rev 0.1

Version Change List (P. I. R. List)

Item	Page#	Title	Date	Request Owner	Issue Description	Solution Description	Rev.
1	47	VCC_CORE	10/8	Compal	To prevent acoustic noise issue	Remove PC923, PC924, PC925, PC926, PC927, PC928, PC929, PC930, PC931, PC940, PC941, PC943, PC946, PC947, PC948 Add PC966	X01
2	42	1.35V_MEN	10/8	RICHTEK	To prevent IC damage	Add PR204	X01
3	46	Charger	10/8	Compal	Fine tune divider voltage	Change PR715, PR729 to 154k	X01
4	41, 43, 44	+1.05V_M +1.5V_RUN +3V/+5V	10/22	Compal	To improve the ability of anti-noise	Change PR307 to 7.5k Change PR310, PR102, PR104, PR403 to 10k Change PR100 to 6.49k Change PR101 to 15k Change PR402 to 8.66k	X01
5	45	VCC_CORE	10/31	Compal	Fine tune IMON	Add PR518, PR524, PR525	X01
6	ALL	ALL	10/31	Compal	RF request	Pop PR522, PC508, PR726, PC721, PC713, PL501, PC520	X01
7	46	Charger	12/05	Compal	Has the same behavior with dock circuit	Add PQ711	X01
8	46	Charger	12/05	Compal	To add 2nd source	Remove PQ702 Add PQ709, PQ710	X01
9	46	Charger	12/05	Compal	To reduce leakage current	Remove PD701 Add PD704, PD705	X01
10	46	Charger	3/03	Compal	To set OVP level	Remove PR729	X02
11	46	Charger	3/03	Compal	To set IC function	Remove PC720 Add PR788, PR799	X02
12	40	DCIN	3/03	Compal	For ME change request	Change PBATT1	X02
13	40	DCIN	3/03	Compal	For EMC change request	Add PD5 PC20 PC21 PC22 Remove PC11	X02

PROPRIETARY NOTE: THIS SHEET OF ENGINEERING DRAWING AND SPECIFICATIONS CONTAINS CONFIDENTIAL TRADE SECRET AND OTHER PROPRIETARY INFORMATION OF DELL EMC. (DELL)'S THIS DOCUMENT MAY NOT BE TRANSMITTED OR COPIED WITHOUT THE EXPRESS WRITTEN AUTHORIZATION OF DELL. IN ADDITION, NEITHER THIS SHEET NOR THE INFORMATION IT CONTAINS MAY BE USED BY OR DISCLOSED TO ANY THIRD PARTY WITHOUT DELL'S EXPRESS WRITTEN CONSENT.

DELL CONFIDENTIAL/PROPRIETARY

Compal Electronics, Inc.

PWR P.I.R (1/1)

LA-A902P

Date: Monday, March 17, 2014 Sheet 48 of 48

Version Change List (P. I. R. List)

Item	Page#	Title	Date	Request Owner	Issue Description	Solution Description	Rev.
1	6	HW	2013/10/8	COMPAL	Follow intel reference circuit.	Add CC100, RC300 on CPU pin AC4, net name is PM_TEST_RST	0.2 (X01)
2	27	HW	2013/10/8	COMPAL	Dell drop POA function.	Change JUSH1 from 26 pin to 20 pin, pin define follow E5	0.2 (X01)
3	36	HW	2013/10/8	COMPAL	Dell drop POA function.	remove POA_WAKE# off page symbol remove POA_ON/OFF#,make UE2.B62 to be NC pin	0.2 (X01)
4	22	HW	2013/10/9	COMPAL			0.2 (X01)
5	24	HW	2013/10/9	COMPAL	correct HDMI schematic error.	swap HDMI LANE0 & LANE2 BUS	0.2 (X01)
6	23	HW	2013/10/9	COMPAL	Follow EMC suggestion	Change LI1,LI2,LI3,LI4,LI5,LI6,LI7,LI8,LI9,LV3,LV6,LV10,LV12,LV27 From SM070003K00 (S COM FI_CHILISIN CMMI21T-900Y-N) To SM070003Y00 (S COM FI_MURATA DLW21HN900HQ2L)	0.2 (X01)
7	9	HW	2013/10/9	COMPAL	reserved for S3 within 2s , system shutdown issue debug.	add RC26, reserved RC27.	0.2 (X01)
8	36	HW	2013/10/9	COMPAL	board ID change.	RE79 change to 130K	0.2 (X01)
9	24	HW	2013/10/9	COMPAL	SATA circuit issue	Swap mSATA P & N	0.2 (X01)
10	36	HW	2013/10/14	COMPAL	follow intel latest design guide.	pop RE56 and change from 8.2K to 10K , it's RESET_OUT# pull down resistor	0.2 (X01)
11	7	HW	2013/10/16	COMPAL	RF requirement.	add CC14, CC15 and move CC12, CC13 to behind the resistor (RC72)	0.2 (X01)
12	20,23,31,32	HW	2013/10/17	COMPAL	follow ESD recommend list.	change all ESD diode CPN change DI2, DI3, DI5, DV4 from SCA00001100(S ZEN ROW PJDLCO5C 3P C/A SOT23) to SC600001600(S DIO ROW AZC199-02S.R7G C/C SOT23 ESD) change DI1,DI6,DI4 from SC300002800(S DIO(BR) TVWDF1004AD0 DFN ESD) to SC300002C00(S DIO(BR) L05ESDL5V0NA-4 SLP2510P8 ESD) change DA1,DA2,DA3,DA6,DA7 from SCA00001L00(S ZEN ROW L30ESDL5V0C3-2 C/A SOT23 ESD) to SCA00002900(S ZEN ROW L03ESDL5V0CC3-2 C/A SOT-23 ESD)	0.2 (X01)
13	38	HW	2013/10/17	COMPAL	power doesn't split VPRO & NPRO BOM.	add RZ41, RZ42, reserve it for VPRO & NVPRO option.	0.2 (X01)
14	39	HW	2013/10/17	COMPAL	SSI design will cause LED behavior error.	QL1 Pin2,5 & QL2 Pin2 change from MASK_BASE_LEDS# to SYS_LED_MASK#	0.2 (X01)

DELL CONFIDENTIAL/PROPRIETARY

Compal Electronics, Inc.

EE P.I.R (1/3)

LA-A972P

Monday, March 17, 2014 Sheet 60 of 70

PROPRIETARY NOTE: THIS SHEET OF ENGINEERING DRAWING AND SPECIFICATIONS CONTAINS CONFIDENTIAL TRADE SECRET AND OTHER PROPRIETARY INFORMATION OF DELL EMC. (DELL)'S THIS DOCUMENT MAY NOT BE TRANSMITTED OR COPIED WITHOUT THE EXPRESS WRITTEN AUTHORIZATION OF DELL. IN ADDITION, NEITHER THIS SHEET NOR THE INFORMATION IT CONTAINS MAY BE USED BY OR DISCLOSED TO ANY THIRD PARTY WITHOUT DELL'S EXPRESS WRITTEN CONSENT.

Version Change List (P. I. R. List)

Item	Page#	Title	Date	Request Owner	Issue Description	Solution Description	Rev.
15	20	HW	2013/10/17	COMPAL	To solve Line-on HDD dirty shut down issue.	UZ8 Pin2 change from +3.3V_ALW to 3.3V_RUN	0.2 (X01)
16	28, 36, 38	HW	2013/10/17	COMPAL	follow Dell requirement.	Add back SUS_ON, change control pin from SUS_ON to SIO_SLP_S4# 1. UZ8.3 from SIO_SLP_S4# to SUS_ON 2. UE2.B23 -- SUS_ON_EC , RPE10.2 -- SUS_ON 3. add RE282, RE281, RE280, RE279 4. UE2.B9 -- RUN_ON_EC	0.2 (X01)
17	12	HW	2013/10/24	COMPAL			0.2 (X01)
18	6	HW	2013/10/24	COMPAL	debug usage.	add RC301	0.2 (X01)
19	9	HW	2013/10/28	COMPAL	reserve it to prevent PCH_PLTRST# floating when power on	add RC304, 100K pull down, on PCH_PLTRST#_EC	0.2 (X01)
20	6, 7, 22, 28	HW	2013/10/23	COMPAL	follow xtal vender suggest	1 CC1 & CC2 change from 18PF to 3PF 2 CC8 & CC11 change from 18PF to 15PF 3 CL13 & CL14 change from 33PF to 27PF 4 RV81 change from 0 ohm to 2.2K & CV113 change to 18PF	0.2 (X01)
21	23	HW	2013/10/29	COMPAL	it's designed for E5 Goliad, E6 GMLK doesn't need.	remove RZ1	0.2 (X01)
22	30	HW	2013/10/29	COMPAL			0.2 (X01)
23	12	HW	2013/10/29	COMPAL	To solve backdrive issue.	Change TPM_PIRQ# pull up (RC247) to +3.3V_RUN from +3.3V_ALW_PCH	0.2 (X01)
24	30	HW	2013/10/30	COMPAL	Dell doesn't support MODPHY.	add PJP36, depop Q26, Q210, RZ16, RZ5, C225, C238	0.2 (X01)
25	7	HW	2013/11/2	COMPAL	SMBUS Pull High	Add RN3sRN4 pull high to +3.3V_RUN for DDR_XDF_WAN_SMBDAT/SMBCLK	0.2 (X01)
26	21	HW	2013/11/2	COMPAL	EMC request.	Add RA42, RA43.	0.2 (X01)
27	21	HW	2013/11/05	COMPAL	follow vender suggestion. It's for 15KV ESD fail issue.	add CA12, CA13 change DA1, DA2, DA3, DA4 from GNDA to GND	0.2 (X01)
28	12	HW	2013/11/05	COMPAL	GPIO 14 is sus power well, it has risk to cause back drive.	move TPM_PIRQ# from PCH_GPIO14 to PCH_GPIO17, add T21 on PCH_GPIO14	0.2 (X01)
39	21	HW	2013/12/17	COMPAL			0.3 (X01)
40	22	HW	2013/12/17	COMPAL			0.3 (X01)

DELL CONFIDENTIAL/PROPRIETARY

Compal Electronics, Inc.

EE P.I.R (2/3)

LA-A972P

Monday, March 17, 2014 Sheet 81 of 70

PROPRIETARY NOTE: THIS SHEET OF ENGINEERING DRAWING AND SPECIFICATIONS CONTAINS CONFIDENTIAL TRADE SECRET AND OTHER PROPRIETARY INFORMATION OF DELL EMC. (DELL)'S THIS DOCUMENT MAY NOT BE TRANSMITTED OR COPIED WITHOUT THE EXPRESS WRITTEN AUTHORIZATION OF DELL. IN ADDITION, NEITHER THIS SHEET NOR THE INFORMATION IT CONTAINS MAY BE USED BY OR DISCLOSED TO ANY THIRD PARTY WITHOUT DELL'S EXPRESS WRITTEN CONSENT.

